LYNC-712/715-4200G4 Series

**Fanless 12.1"/15" Industrial Panel PC with
Intel® N4200 Quad-Core™ Processor**

User's Manual **Version 1.0**

Revision History

Version	Time	Description
1.0	2018.05	Initial release

Revision History	ii
Contents	i
Preface.....	iii
Copyright Notice	iii
Declaration of Conformity	iii
CE.....	iii
FCC Class A	iii
RoHS	iv
SVHC / REACH	iv
Important Safety Instructions	v
Warning.....	vi
Lithium Battery Replacement.....	vi
Technical Support	vi
Warranty.....	vii
Chapter 1 - Introduction.....	1
1.1. The Computer	2
1.2. About this Manual	2
1.3. Specifications.....	3
1.4. Inside the Package	5
1.5. Ordering Information.....	5
1.5.1. Optional Accessories	6
1.5.2. Configure-to-Order Service.....	6
Chapter 2 - Getting Started.....	7
2.1. Dimensions	8
2.2. Tour the Computer	9
2.2.1. Front View.....	9
2.2.2. Rear View	10
2.2.3. Bottom View.....	10
2.2.4. Top View	11
2.3. Driver Installation	11
Chapter 3 - Engine of the Computer.....	13
3.1. Board Layout.....	14
3.1.1. CPU Module (EmQ-i2401).....	14
3.1.2. Daughterboard (SCDB-141B, optional).....	14
3.1.3. Carrier Board (PBQ-9014).....	15
3.2. Jumpers and Connectors.....	16
3.2.1. Jumpers	16
3.2.2. Connectors	20
Chapter 4 - Installation and Maintenance.....	27

4.1. Use Onboard Jumpers and Connectors	28
4.2. Install Hardware	29
4.2.1. Install SSD or HDD	29
4.2.2. Install CFast Card	30
4.2.3. Install Wi-Fi Module	31
4.3. Mount the Computer	32
4.3.1. Panel Mounting	32
4.3.2. VESA Mounting	33
4.4. Wire DC-Input Power Source	36
Chapter 5 - BIOS	37
5.1. Main	40
5.2. Advanced	41
5.2.1. F81866 Super IO Configuration	42
5.2.2. Hardware Monitor	44
5.2.3. CPU Configuration	45
5.2.4. CSM Configuration	45
5.2.5. USB Configuration	46
5.3. Chipset	47
5.3.1 LCD Control	48
5.3.2 HD-Audio Configuration	48
5.3.3 PCI Express Configuration	48
5.3.4 SATA Drives	49
5.3.5 USB Configuration	49
5.4. Security	50
5.5. Boot	51
5.6. Exit	52
Appendices	53
Appendix A: WIFI-AT4550 Hardware Installation	54
A.1. Install WIFI-AT4550	54
Appendix B: PenMount Utilities	58
B.1. PenMount Control Panel	58
B.2. PenMount Gesture	63

Copyright Notice

All Rights Reserved.

The information in this document is subject to change without prior notice in order to improve the reliability, design and function. It does not represent a commitment on the part of the manufacturer.

Under no circumstances will the manufacturer be liable for any direct, indirect, special, incidental, or consequential damages arising from the use or inability to use the product or documentation, even if advised of the possibility of such damages.

This document contains proprietary information protected by copyright. All rights are reserved. No part of this document may be reproduced by any mechanical, electronic, or other means in any form without prior written permission of the manufacturer.

Declaration of Conformity

CE

The CE symbol on your product indicates that it is in compliance with the directives of the Union European (EU). A Certificate of Compliance is available by contacting Technical Support.

This product has passed the CE test for environmental specifications when shielded cables are used for external wiring. We recommend the use of shielded cables. This kind of cable is available from ARBOR. Please contact your local supplier for ordering information.

Warning

This is a class A product. In a domestic environment this product may cause radio interference in which case the user may be required to take adequate measures.

FCC Class A

This device complies with Part 15 of the FCC Rules. Operation is subject to the following two conditions:

- (1) This device may not cause harmful interference, and
- (2) This device must accept any interference received, including interference that may cause undesired operation.

NOTE:

This equipment has been tested and found to comply with the limits for a Class A digital device, pursuant to Part 15 of the FCC Rules. These limits are designed to provide reasonable protection against harmful interference when the equipment is operated in a commercial environment. This equipment generates, uses, and can radiate radio frequency energy and, if not installed and used in accordance with the instruction manual, may cause harmful interference to radio communications. Operation of this equipment in a residential area is likely to cause harmful interference in which case the user will be required to correct the interference at his own expense.

RoHS

ARBOR Technology Corp. certifies that all components in its products are in compliance and conform to the European Union's Restriction of Use of Hazardous Substances in Electrical and Electronic Equipment (RoHS) Directive 2002/95/EC.

The above mentioned directive was published on 2/13/2003. The main purpose of the directive is to prohibit the use of lead, mercury, cadmium, hexavalent chromium, polybrominated biphenyls (PBB), and polybrominated diphenyl ethers (PBDE) in electrical and electronic products. Member states of the EU are to enforce by 7/1/2006.

ARBOR Technology Corp. hereby states that the listed products do not contain unintentional additions of lead, mercury, hex chrome, PBB or PBDB that exceed a maximum concentration value of 0.1% by weight or for cadmium exceed 0.01% by weight, per homogenous material. Homogenous material is defined as a substance or mixture of substances with uniform composition (such as solders, resins, plating, etc.). Lead-free solder is used for all terminations (Sn(96-96.5%), Ag(3.0-3.5%) and Cu(0.5%)).

SVHC / REACH

To minimize the environmental impact and take more responsibility to the earth we live, Arbor hereby confirms all products comply with the restriction of SVHC (Substances of Very High Concern) in (EC) 1907/2006 (REACH --Registration, Evaluation, Authorization, and Restriction of Chemicals) regulated by the European Union.

All substances listed in SVHC < 0.1 % by weight (1000 ppm)

Important Safety Instructions

Read these safety instructions carefully

1. Read all cautions and warnings on the equipment.
2. Place this equipment on a reliable surface when installing. Dropping it or letting it fall may cause damage
3. Make sure the correct voltage is connected to the equipment.
4. For pluggable equipment, the socket outlet should be near the equipment and should be easily accessible.
5. Keep this equipment away from humidity.
6. The openings on the enclosure are for air convection and protect the equipment from overheating. **DO NOT COVER THE OPENINGS.**
7. Position the power cord so that people cannot step on it. Do not place anything over the power cord.
8. Never pour any liquid into opening. This may cause fire or electrical shock.
9. Never open the equipment. For safety reasons, the equipment should be opened only by qualified service personnel.
10. If one of the following situations arises, get the equipment checked by service personnel:
 - a. The power cord or plug is damaged.
 - b. Liquid has penetrated into the equipment.
 - c. The equipment has been exposed to moisture.
 - d. The equipment does not work well, or you cannot get it to work according to the user's manual.
 - e. The equipment has been dropped or damaged.
 - f. The equipment has obvious signs of breakage.
11. Keep this User's Manual for later reference.

Warning

The Panel PC and its components contain very delicately Integrated Circuits (IC). To protect the Panel PC and its components against damage caused by static electricity, you should always follow the precautions below when handling it:

1. Disconnect your Panel PC from the power source when you want to work on the inside.
2. Use a grounded wrist strap when handling computer components.
3. Place components on a grounded antistatic pad or on the bag that came with the Panel PC, whenever components are separated from the system.

Lithium Battery Replacement

Incorrect replacement of the lithium battery may lead to a risk of explosion.

The lithium battery must be replaced with an identical battery or a battery type recommended by the manufacturer.

Do not throw lithium batteries into the trash can. It must be disposed of in accordance with local regulations concerning special waste.

Technical Support

If you have any technical difficulties, please consult the user's manual first at:
<ftp://ftp.arbor.com.tw/pub/manual>

Please do not hesitate to call or e-mail our customer service when you still cannot find out the answer.

<http://www.arbor-technology.com>

Warranty

This product is warranted to be in good working order for a period of one year from the date of purchase. Should this product fail to be in good working order at any time during this period, we will, at our option, replace or repair it at no additional charge except as set forth in the following terms. This warranty does not apply to products damaged by misuse, modifications, accident or disaster.

Vendor assumes no liability for any damages, lost profits, lost savings or any other incidental or consequential damage resulting from the use, misuse of, or inability to use this product. Vendor will not be liable for any claim made by any other related party.

Vendors disclaim all other warranties, either expressed or implied, including but not limited to implied warranties of merchantability and fitness for a particular purpose, with respect to the hardware, the accompanying product's manual(s) and written materials, and any accompanying hardware. This limited warranty gives you specific legal rights.

Return authorization must be obtained from the vendor before returned merchandise will be accepted. Authorization can be obtained by calling or faxing the vendor and requesting a Return Merchandise Authorization (RMA) number. Returned goods should always be accompanied by a clear problem description.

This page is intentionally left blank.

Chapter 1

Introduction

1.1. The Computer

ARBOR's LYNC-712 & 715-4200G4 is cost-effective industrial panel PC featuring light weight and slim form factor. The computer comes with rich I/O to meet the demand of the automation and manufacturing process required in modern factories. The system includes four serial ports, five USB ports, one DVI port and two LAN ports. The computer also supports one CFast card and features one 2.5" drive bay for extensive data storage. One PCI Express Mini-card is also built on the main board of the computer to enhance the system with Wi-Fi networking.



Product Highlights

- Intel® Apollo Lake-based Panel PC
- Fewer cables, fanless design
- 12.1" (LYNC-712) or 15" (LYNC-715) 1024 x 768 XGA LCD display w/ LED backlight
- Front bezel with completely covered membrane
- Flush front panel, IP65-compliant
- Brightness control button
- Outside-accessible push-pull CFast socket
- Outside-accessible USB port with rubber cover on the front bezel
- Serial ports (RS-485), w/ auto-flow control
- 1 x MiniCard socket for WiFi module
- 2 x SMA antenna Holes for optional WiFi function
- 9~36V wide-range DC input with reverse protection

1.2. About this Manual

This manual is meant for the experienced users and integrators with hardware knowledge of personal computers. If you are not sure about the description in this manual, consult your vendor before further handling.

We recommend that you keep one copy of this manual for the quick reference for any necessary maintenance in the future. Thank you for choosing ARBOR products.

1.3. Specifications

System	
CPU	Intel® N4200 Quad-Core™ Processor 1.10GHz
Memory	Soldered onboard 4GB DDR3L SDRAM
LAN	1 x Intel® i210IT GbE controller 1 x Realtek® 8111E GbE controller
Watchdog Timer	1~255 levels reset
Storage	
1st Device	1 x outside-accessible CFAST slot
2nd Device	1 x 2.5" drive bay
Audio	
Speaker	2 x 1.5W speakers (optional)
LCD Display	
Size/Type	12.1" TFT LCD Panel (LYNC-712) 15" TFT LCD Panel (LYNC-715)
Max. Resolution	1024 x 768, XGA
Max. Colors	16.7M
Luminance	LYNC-712: 350 cd/m ² , LYNC-715: 420 cd/m ²
Touch Screen	5-wire Analog Resistive
View Angle (U/D/R/L)	80°/80°/80°/80°
Button & Indicator	
Function Key	Brightness up/down, Screen on/off
LED Indicator	Power on LED
Power System	
Power Input	DC 9~36V
Power Consumption	LYNC-712: Max. 23.37W (w/o I/O cards) LYNC-715: Max. 23.95W (w/o I/O cards)
Qualification	
Certification	CE, FCC Class A

Expansion	
Expansion Bus	1 x Mini-card socket (Full Size)
External I/O	
Serial Ports	4 x DB-9 connectors for COM1~4 (COM1 ~ COM4 are RS-232/485 configurable)
USB Ports	4 x Type-A USB 2.0 ports (rear)
	1 x Type-A USB 2.0 port with rubber cover on front bezel
LAN	2 x RJ-45 GbE ports
DVI	1 x DVI-I connector (support DVI only)
WiFi	2 x SMA antenna holes for optional WiFi function
Mechanical	
Mounting Type	Panel Mounting and VESA-75/100 Mounting
Chassis	Panel-mounting chassis, aluminum front bezel and SECC steel chassis
Dimension (W x H x D)	LYNC-712: 325.86 x 258.86 x 53.50 mm (12.8" x 10.2" x 2.11") LYNC-715: 389.93 x 309.93 x 56.96 mm (15.4" x 12.2" x 2.24")
Weight (Net)	LYNC-712: 2.4 kg (without VESA bracket) LYNC-715: 3.6 kg (without VESA bracket)
Environmental	
Operating Temp.	-20 ~ 55°C (-4 ~ 131°F)
Storage Temp.	-20 ~ 70°C (-4 ~ 158°F)
Operating Humidity	10 ~ 95% RH @ 55°C (non-condensing)
Vibration	5 ~ 500Hz, 2Grms X,Y,Z axis (with CFast/SSD)
Shock	Operating 20G, 11ms X,Y,Z axis (with CFast/SSD)
OS Support	
Windows®10 (64bit)	

1.4. Inside the Package

Upon opening the package, carefully inspect the contents. If any of the items is missing or appears damaged, contact your local dealer or distributor. The package should contain the following items:



1 x LYNC-712 or 715-4200G4 industrial panel PC



1 x **Accessory Box** that contains the following items:

- Driver CD
- User's manual
- Screws/ Panel mount hook
- 3-pin plug for terminal block

1.5. Ordering Information

LYNC-712-4200G4 12.1" Intel® N4200 Quad-Core™ processor industrial panel PC with 4GB Memory

LYNC-715-4200G4 15" Intel® N4200 Quad-Core™ processor industrial panel PC with 4GB Memory

1.5.1. Optional Accessories

The following items are normally optional, but some vendors may include them in the standard package, or some vendors may not carry all the items.

**PAC-
P060W-02**

12V/5A 60W AC/DC power adapter kit



VMB-712

LYNC-712 VESA-mount bracket kit, w/ 75 x 75 mm & 100 x 100 mm VESA supports



VMB-715

LYNC-715 VESA-mount bracket kit, w/ 75 x 75 mm & 100 x 100 mm VESA supports



1.5.2. Configure-to-Order Service

Make the computer more tailored to your needs by selecting one or more components from the list below to be fabricated to the computer.

150GB SSD

Intel® 2.5" 150GB SATAIII SSD kit



WiFi-AT4550

Atheros, QCNFA324 WiFi module w/
2*30cm internal wiring



ANT-D11

1 x WiFi Dual-band 2.4G/5G antenna



ADK-712

LYNC-71x audio kit



Chapter 2

Getting Started

2.1. Dimensions

LYNC-712-4200G4

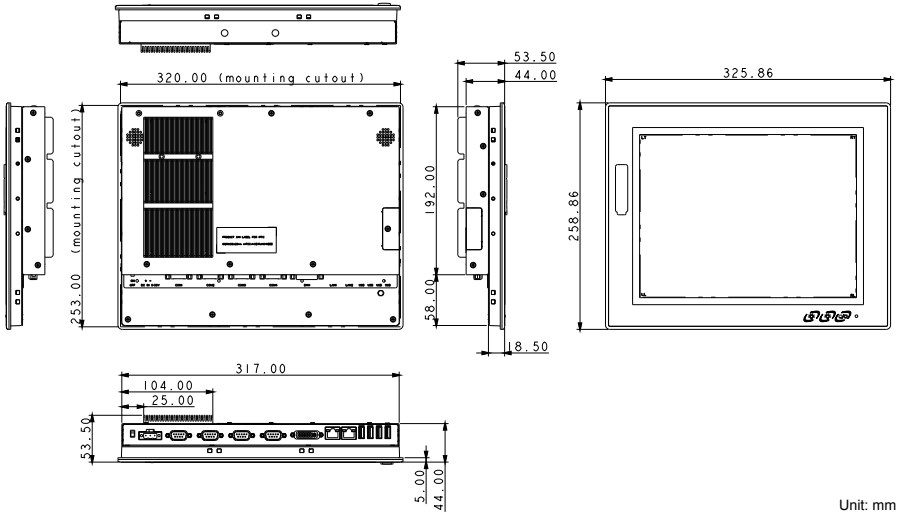

LYNC-715-4200G4

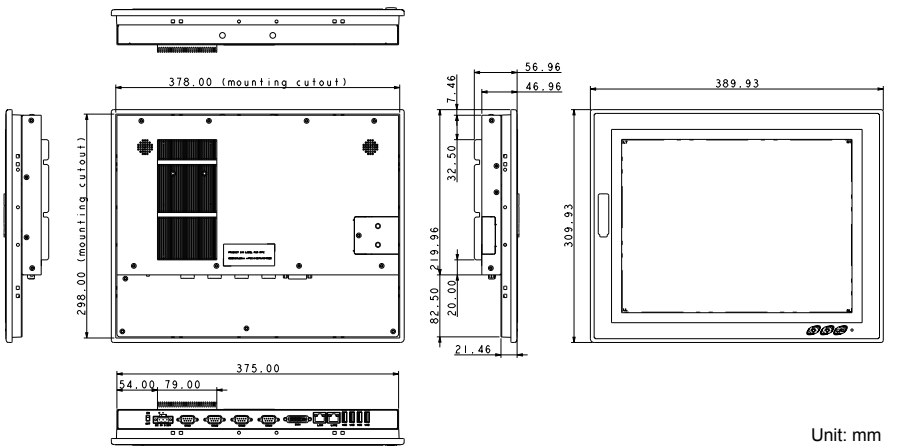



2.2. Tour the Computer

Take a look around the computer and find the external controls and connectors. The appearance of LYNC-712-4200G4 and LYNC-715-4200G4 are similar. This section will use the image of LYNC-715-4200G4 as the example.

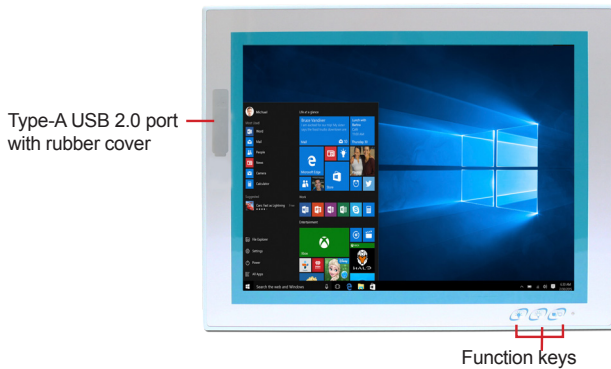
2.2.1. Front View



Use the function keys to launch the following actions from the computer:

Icon	Description
	Turns on/off the LCD display.
	Decreases LCD backlight.
	Increases LCD backlight.

2.2.2. Rear View

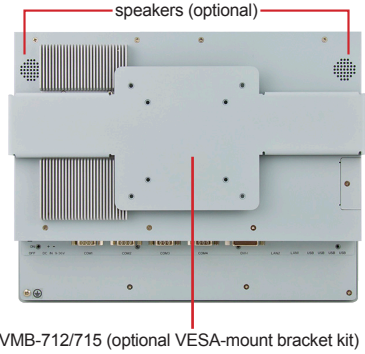

2.2.3. Bottom View

The bottom side of the computer is where the computer's I/O ports are.

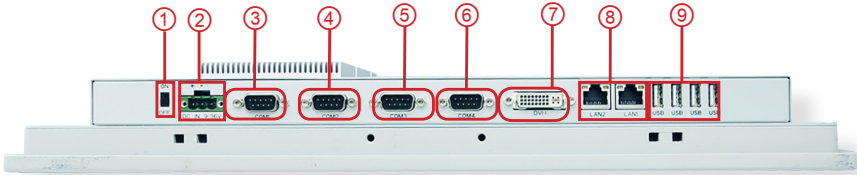

No.	Description
①	Power switch,
②	9~36V DC In power terminal receptable
③ ④ ⑤ ⑥	DB-9 connectors of COM1, COM2, COM3, COM4, RS-232/485 configurable
⑦	DVI port, supporting DVI-D display only
⑧	2 x RJ-45 GbE ports
⑨	4 x Type-A USB 2.0 ports (rear)

2.2.4. Top View



2.3. Driver Installation

Windows 10 64-bit

Device	Driver Path
Chipset	\\Win10\Chipset\SetupChipset.exe
Ethernet	\\Win10\Ethernet\Intel LAN\PROWinx64.exe
	\\Win10\Ethernet\Realtek LAN\Install_Win10_10009_07202016\setup.exe
Graphic	\\Win10\Graphic\Setup.exe
Serial IO	\\Win10\Serial IO\SerialIO_30.100.1620.02_APL_PV_Win10\x64\SetupSerialIO.exe
TXE	\\Win10\TXE\SetupTXE.exe
USB TO UART	\\Win10\USB To UART\XRUSB-Windows-DriversOnly-Vers2.2.0.0\EXE\xrusbser_ver2200_installer.EXE
Touch	After everything is installed properly, please execute this program to do calibration: \\Win10\5 Wire Resistive Touch\PenMount-Windows-USB-Driver-V2.4.5.365_WHQL\Setup.exe

*Note: Refer to [Appendix B: PenMount Utilities on page 58](#) for how to use touch panel.

This page is intentionally left blank.

Chapter 3

Engine of the Computer

3.1. Board Layout

The engine of the computer is constructed by the CPU module EmQ-i2401, the carrier board PBQ-9014 and the optional daughterboard SCDB-141B.

3.1.1. CPU Module (EmQ-i2401)

Top View

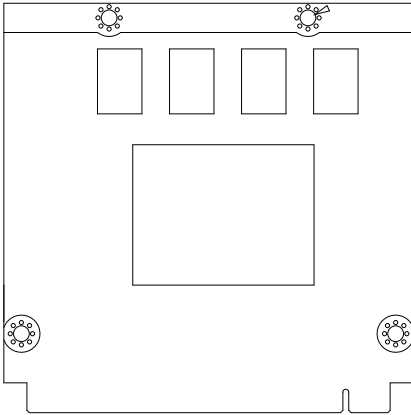

Bottom View

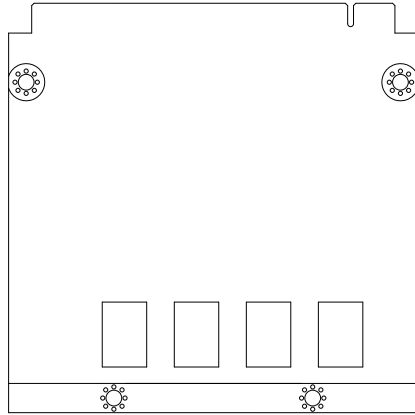

3.1.2. Daughterboard (SCDB-141B, optional)

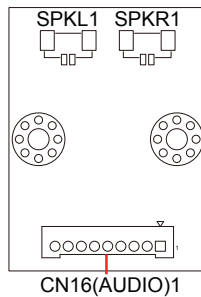

3.1.3. Carrier Board (PBQ-9014)

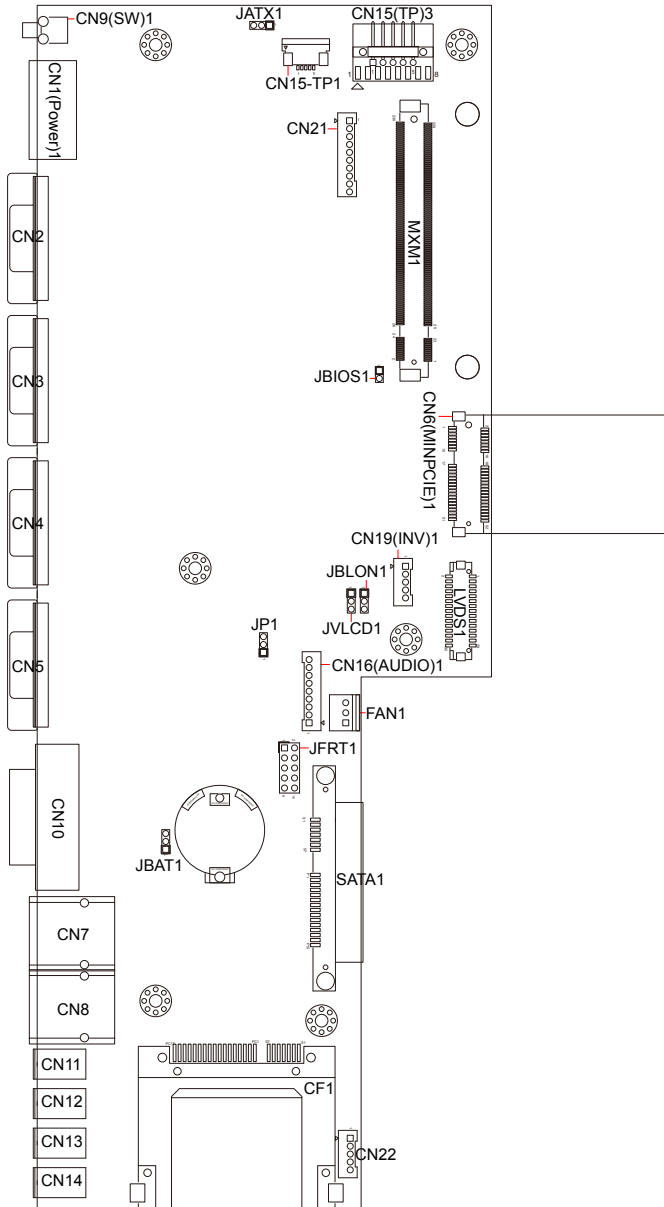

3.2. Jumpers and Connectors

This chapter will explicate each of the jumpers and connectors on the carrier board of the computer.

3.2.1. Jumpers

JATX1

Function: AT/ATX MODE

Selection

Jumper Type: 2.00mm-pitch

1x3-pin header

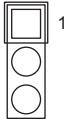

Setting:

Pin	Description	Setting
1-2	AT (default)	

2-3	ATX	
-----	-----	--

JBIOS1

Function: BIOS selector

Jumper Type: 2.00mm-pitch

1x2-pin open type jumper



Setting:

Pin	Description	Setting
ON	Boot the computer from the carrier board's flash ROM BIOS.	<p>The short-circuit-cap is used on both pins.</p>

OFF	Boot the computer from the CPU board's flash ROM BIOS (default).	<p>The short-circuit-cap is removed.</p>
-----	--	--

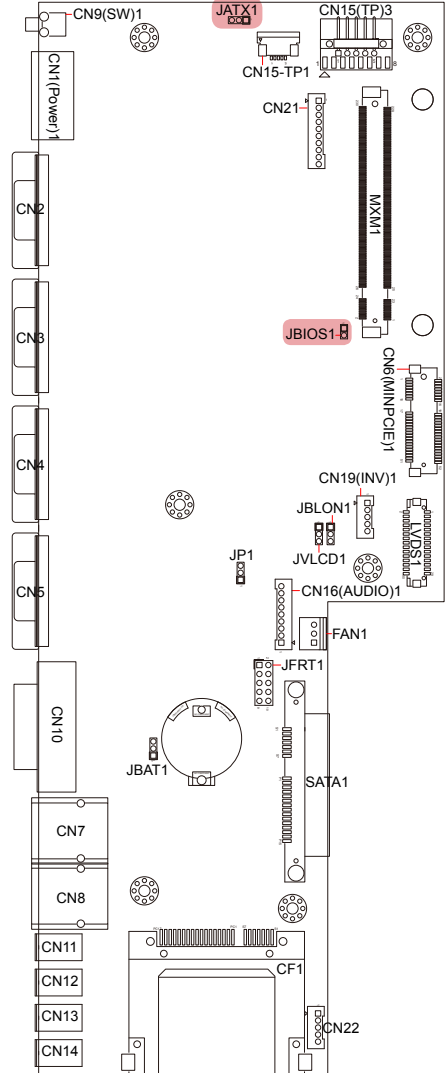

JFRT1

Function: front panel LED indication

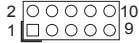

Jumper Type: 2.54mm-pitch 2x5-pin header

Setting:

Pin	Description	Setting
1-2	system reset	
3-4	power LED+	
5-6	HDD LED+	
7-8	speaker	
9-10	power button	

JBAT1

Function: COMS setting
Jumper Type: 2.00mm-pitch 1x3-pin header

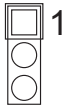

Setting:

Pin	Description	Setting
1-2	keep CMOS (default)	
2-3	clear CMOS	

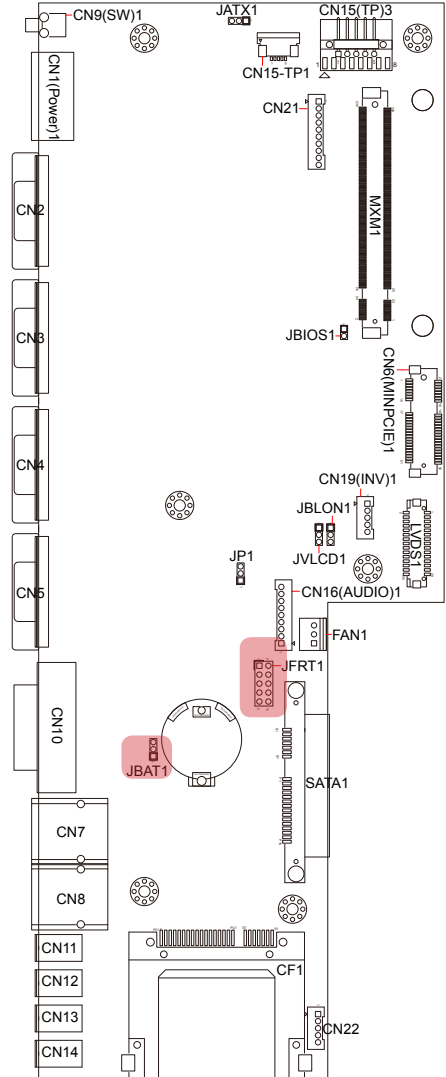

JVLCD1

Function: LCD power selection
Jumper Type: 2.00mm-pitch
 1x3-pin header

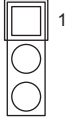

Setting:

Pin	Description	Setting
1-2	5V	

2-3	3.3V (default)	
-----	-------------------	--

JBLON1

Function: LCD backlight
 activeness selection
Jumper Type: 2.00mm-pitch
 1x3-pin header

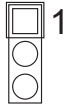

Setting:

Pin	Description	Setting
1-2	negative active	

2-3	positive active (default)	
-----	------------------------------	--

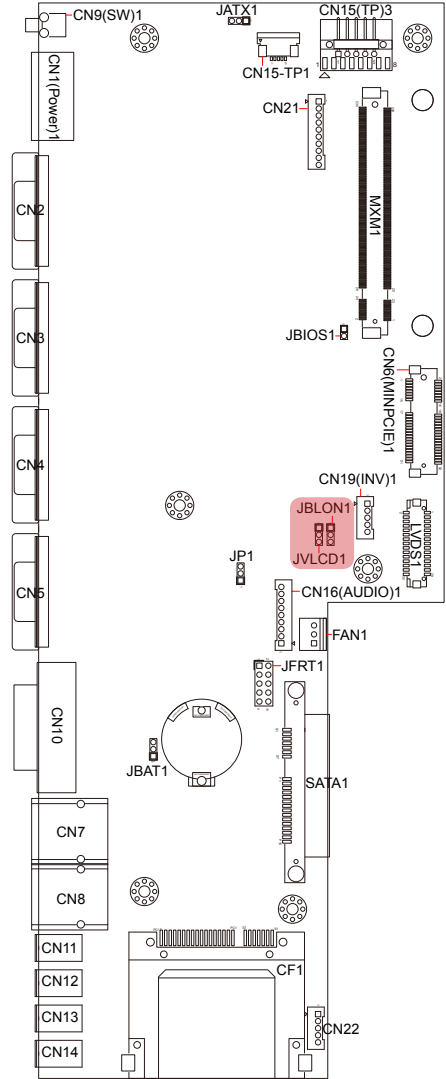

JP1

Function: COM1 function selection

Jumper Type: 2.00mm-pitch 1x3-pin header

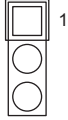

Setting:

Pin	Description	Setting
1-2	for factory testing	
2-3	normal (default)	

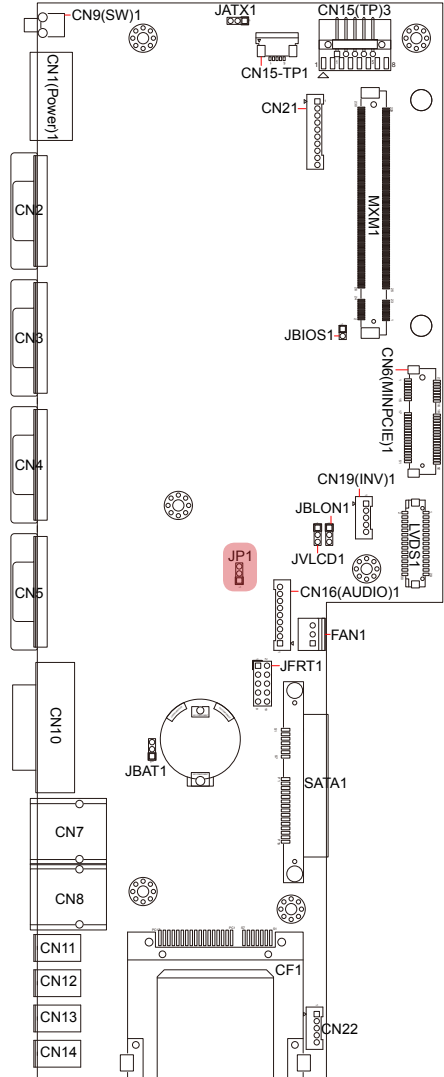

3.2.2. Connectors

CN19(INV)1

Function: inverter connector

Connector Type: 2.00mm-pitch 1x5-pin 4-wall wafer connector

Setting:

Pin	Description
1	+12V/+5V
2	GND
3	BL-ON
4	BL-Control
5	GND

CN1(Power)1

Function: power input

Connector Type: 5.00mm-pitch 3-pole male-type euro-style terminal block

Setting:

Pin	Description
1	POWER+(9~36V)
2	POWER-
3	GND

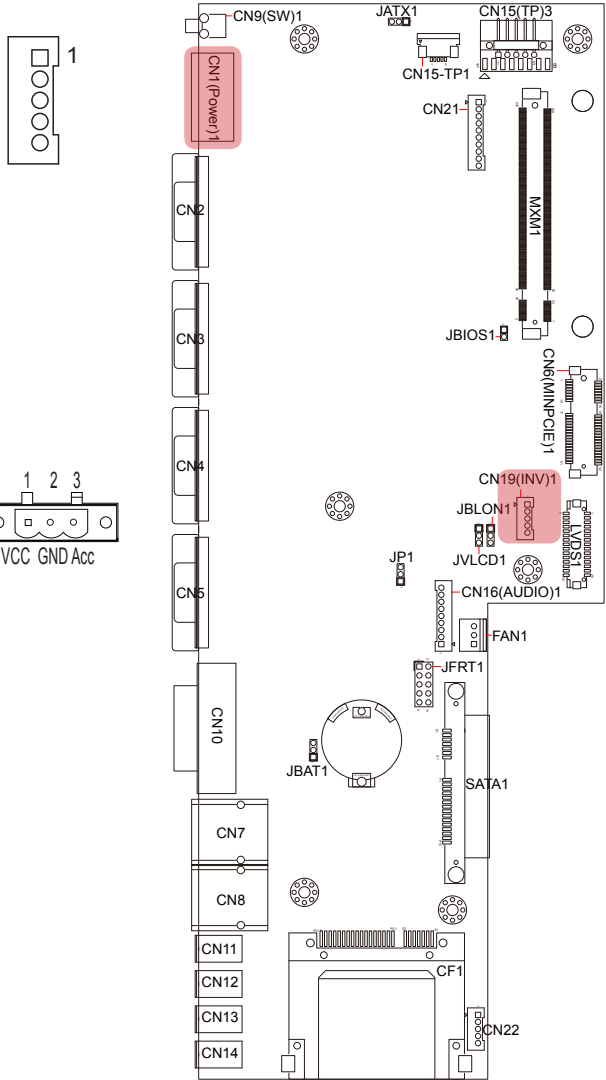

CN21

Function: USB 3.0 connectors

Connector Type: 1x10-pin header

Setting:

Pin	Desc.	Pin	Desc.
1	VCC5	6	NC
2	D-	7	NC
3	D+	8	NC
4	GND	9	NC
5	NC	10	GND

CN21(USB)1

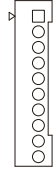

CN22

Function: USB connectors

Connector Type: 2.54mm-pitch 1x5-pin header

Setting:

Pin	Description
1	5VCC
2	Data-
3	Data+
4	GND
5	GND

CN22(USB)1



CN15-TP1

Function: membrane connector

Connector Type: 1x5-pin FPC downside connector

Setting:

Pin	Description
1	Panel-PWM-
2	Panel-PWM+
3	Power SW
4	Power LED
5	GND

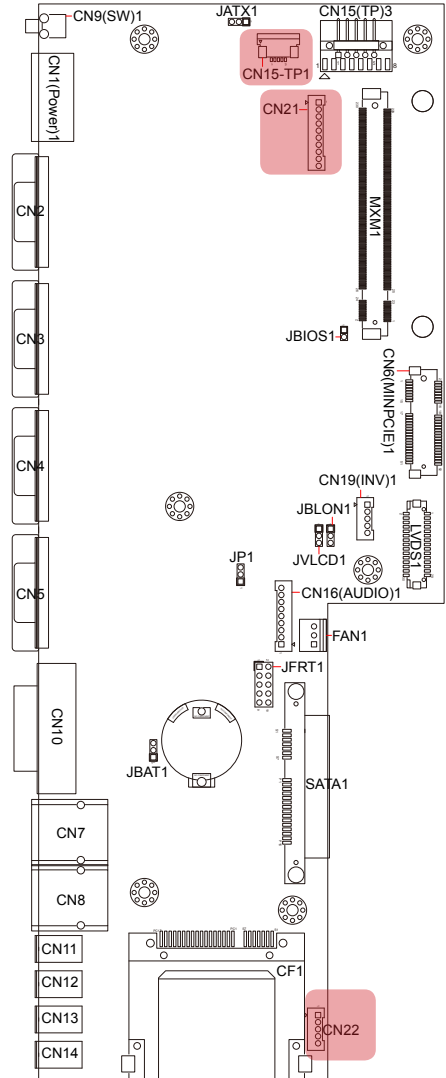
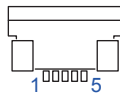

CN15(TP)3

Function: touch panel connector
Connector Type: 2.54mm-pitch 1x5-pin header
Setting:

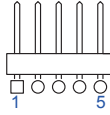

Pin	Description
1	Y+
2	X+
3	Sense
4	Y-
5	X-

LVDS1

Function: LCD connector
Connector Type: DF-13-30DP-1.25V connector



Setting:

Pin	Description	Pin	Description
2	VDD	1	VDD
4	TX2CLK+	3	TX1CLK+
6	TX2CLK-	5	TX1CLK-
8	GND	7	GND
10	TX2D0+	9	TX1D0+
12	TX2D0-	11	TX1D0-
14	GND	13	GND
16	TX2D1+	15	TX1D1+
18	TX2D1-	17	TX1D1-
20	GND	19	GND
22	TX2D2+	21	TX1D2+
24	TX2D2-	23	TX1D2-
26	GND	25	GND
28	TX2D3+	27	TX1D3+
30	TX2D3-	29	TX1D3-

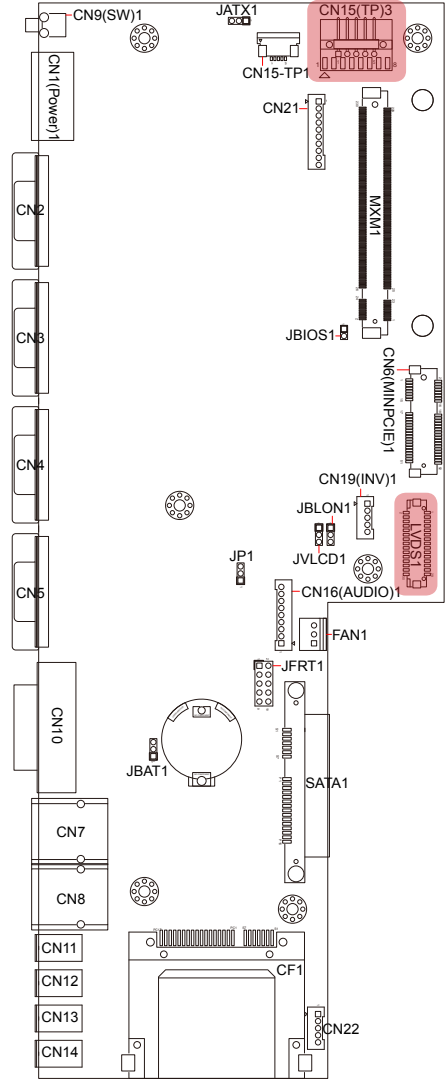

CN2~CN5

Function: COM1~4

Connector Type: 9-pin male-type DSUB connector

Setting: RS-232



Pin	Description	Pin	Description
1	DCD	6	DSR
2	RXD	7	RTS
3	TXD	8	CTS
4	DTR	9	5V
5	GND	10	NC

Setting: RS-485

Pin	Description	Pin	Description
1	485-	6	NC
2	485+	7	NC
3	NC	8	NC
4	NC	9	NC
5	NC	10	NC

Note: To switch the COM port mode, please refer to [5.2.1. F81866 Super IO Configuration](#) on page [42](#).

CN10

Function: DVI-I port (digital)

Connector Type: 29-pin DIP-type female connector

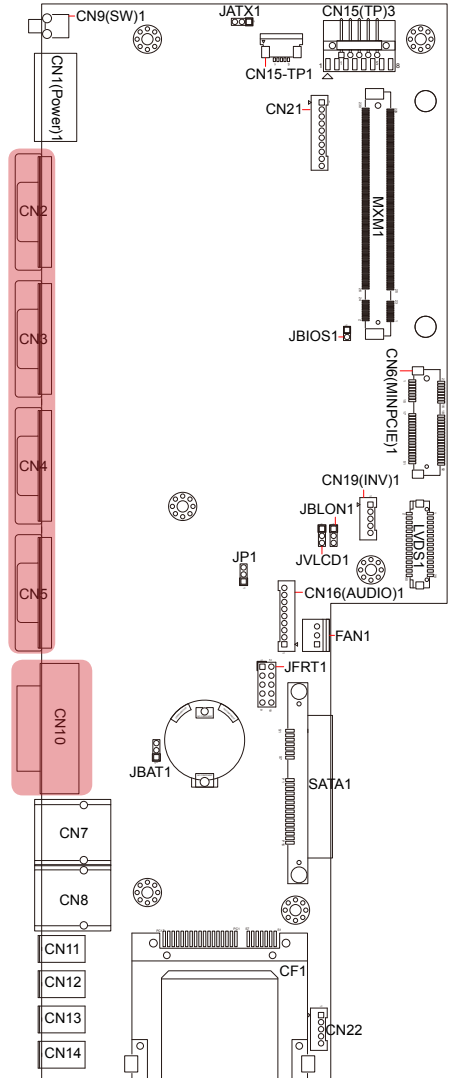
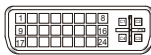

CN7~CN8

Function: RJ-45 Ethernet connectors

Connector Type:

10/100/1000Mbps Fast Ethernet

Setting:

Pin	Description	Pin	Description
1	MDI0	5	MDI2
2	MDI0#	6	MDI2#
3	MDI1	7	MDI3
4	MDI1#	8	MDI3#

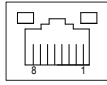

CN11~CN14

Function: USB2.0 ports

Connector Type: double stack

USB2.0 type A connector

Setting:

Pin	Description
1	5V
2	USB D-
3	USB D+
4	GND

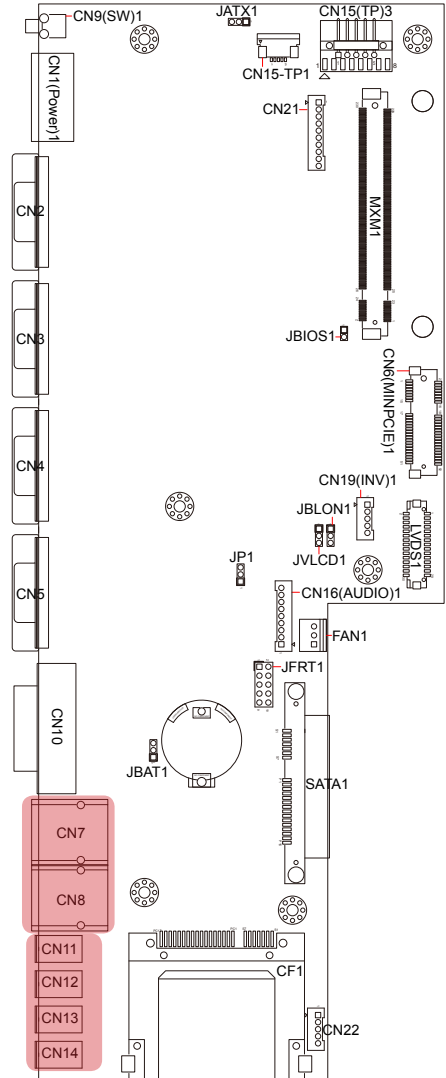
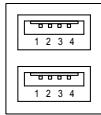

CN6(MINPCIE)1

Function: PCI Express MiniCard socket
Connector Type: onboard 0.8mm pitch 52-pin edge card connector

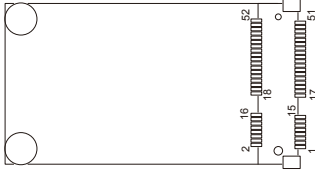

CF1

Function: CFast card Type I/II socket
Connector Type: 7+17-pin CFast card connector consisting of a SATA compatible 7-pin signal connector and a 17-pin power control connector.

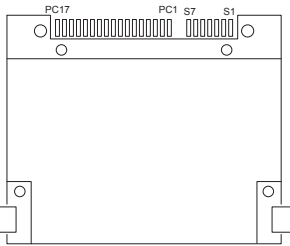

SATA1

Function: S-ATA1 connector
Connector Type: SATA port with data + power vertical connector (7+15pin)

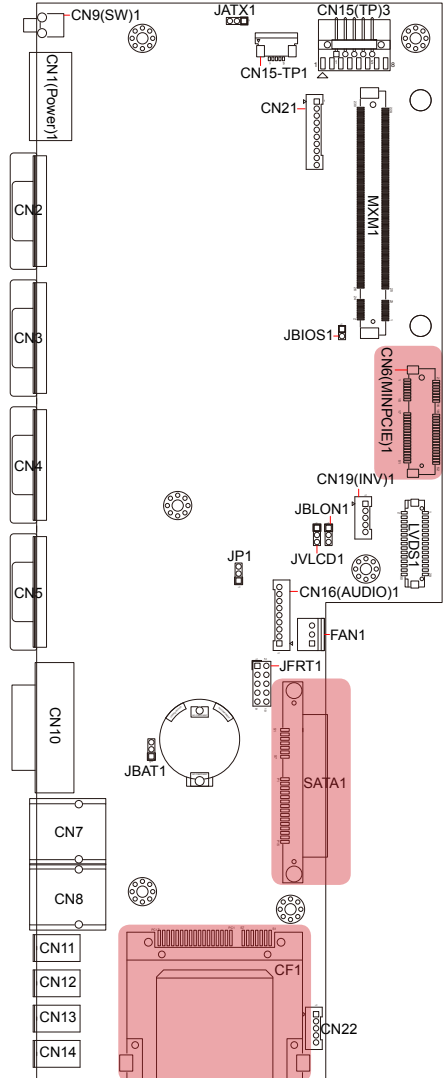
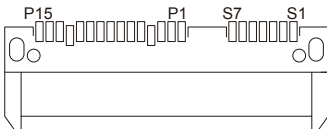

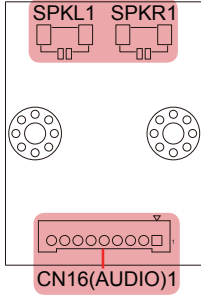

CN16(Audio)1

Function: audio connector
Connector Type: 2.00mm-pitch
 1x9-pin 4-wall wafer connector
Setting:

Pin	Description
1	12VCC
2	3VCC
3	HDA_SYNC
4	HAD_SDOUT
5	GND
6	HDA_CLK
7	GND
8	HDA_RST#
9	HDA_SDINO

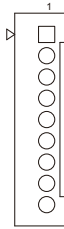

SPKL1 or SPKR1

Function: left or right speaker connector

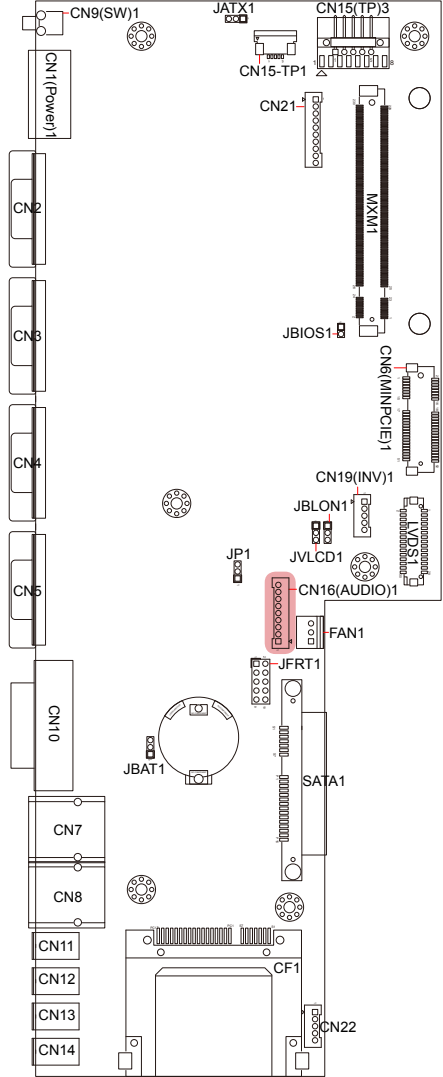

Chapter 4

Installation & Maintenance

4.1. Use Onboard Jumpers and Connectors

The computer's carrier board PBQ-9014 comes with some connectors to join some devices and also some jumpers to alter hardware configuration. Follow through the guide below to access these components inside the computer. As LYNC-712 & 715 merely differ in size, the subsequent images take LYNC-715 for instance.

1. Loosen and remove the screws from the computer's rear panel.

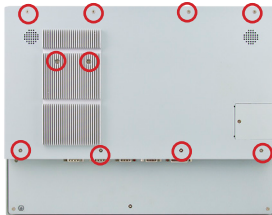

LYNC-715-4200G4

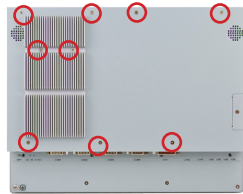

LYNC-712-4200G4

2. Loosen and remove the 4 screws from each of the left and right side respectively.



3. Dismount the rear cover from the computer. The inside of the computer comes to view.

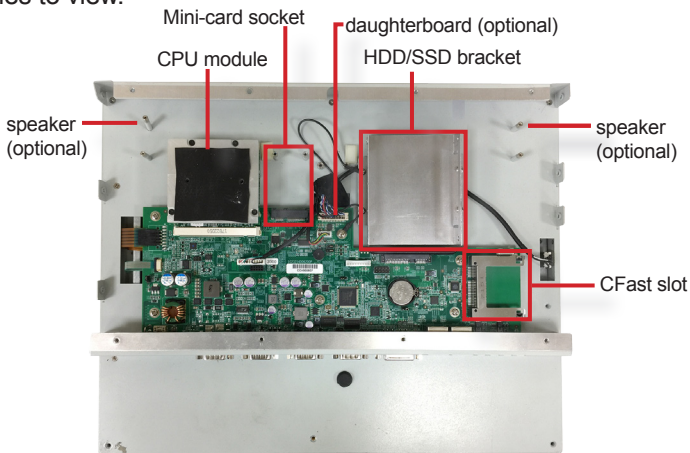

- Adjust the jumpers or use the connectors on the carrier board as described in [3.2.1. Jumpers](#) on page [16](#) and [3.2.2. Connectors](#) on page [20](#). Be noted that the speakers and daughterboard are parts of ADK-712 module. Refer to [1.5.2. Configure-to-Order Service on page 6](#) for details.

4.2. Install Hardware

The following sections will guide you through the basic hardware installation for the computer. Remember to turn off the panel PC before installing/removing inner hardware.

4.2.1. Install SSD or HDD

The computer supports a 2.5" HDD or SSD to work inside the computer. To install a 2.5" HDD or SSD to the computer, slide a 2.5" HDD or SSD storage device to the bracket. Fix them together by using four screws at the bracket's both sides. See the illustration below.

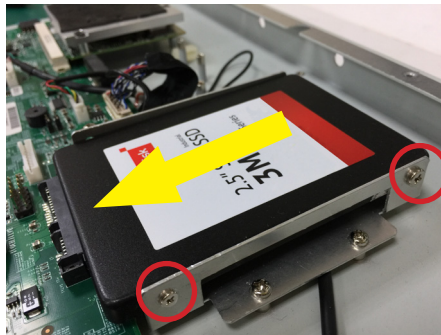

4.2.2. Install CFast Card

The computer comes with a CFast slot to power the computer with a CFast card. To install a CFast card to the computer:

1. Locate the CFast slot. Remove the screw and take off the CFast slot door.



2. Have a CFast card. Push the CFast card into the slot so the card can be clicked in place. Push again if you want to have the card ejected.



3. Restore the CFast slot door to the computer.

Caution: To eject the CFast card, make sure to push the middle of the card. DO NOT push only one side of the card to prevent the card from getting stuck in the slot.



To eject the card properly, always push the middle of the card.

4.2.3. Install Wi-Fi Module

The computer comes with one Mini-card socket to load the computer with a wireless module of PCI Express Mini-card form factor. The configure-to-order Wi-Fi module available with the computer is WIFI-AT4550:



WiFi-AT4550
Atheros, QCNFA324 WiFi module w/ 2*30cm internal wiring

(See also [1.5.2. Configure-to-Order Service](#) on page [6](#).)

- If you have ordered the Wi-Fi module WIFI-AT4550, see [Appendix A: WIFI-AT4550 Hardware Installation](#) to know how to install the hardware and software for the module.

4.3. Mount the Computer

Integrate the computer to where it works by mounting it to a wall in the surroundings or to the rear of a display monitor. Similarly, the subsequent illustrations only take LYNC-715 for instance.

4.3.1. Panel Mounting

1. Have the panel-mounting clamps included in accessory pack. Put the clamps into holes around edges of the panel PC as below.

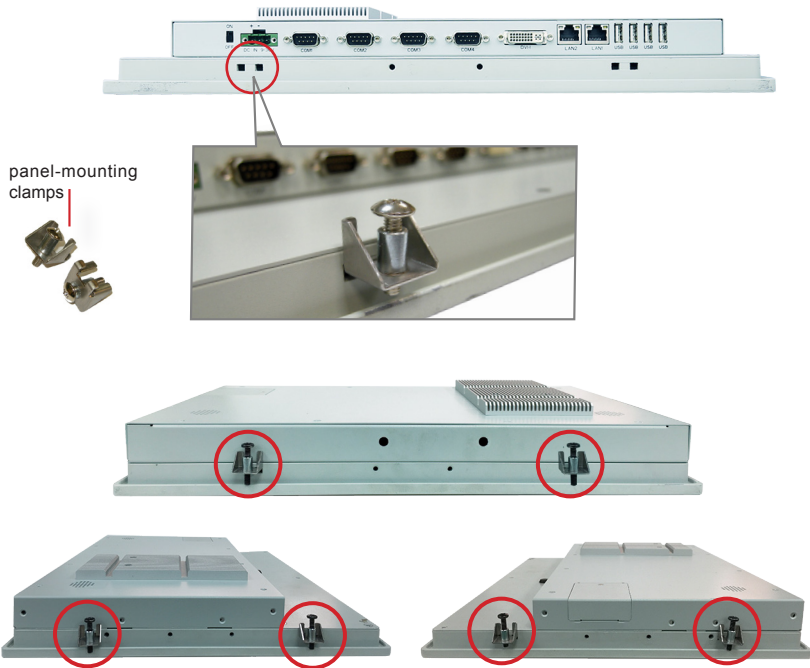

2. Put the panel PC into correct-sized frame on a wall or other devices and tightly screw panel-mounting clamps around edges.

4.3.2. VESA Mounting

To support VESA-mounting, the computer needs a VESA bracket, which is available in [1.5.2. Configure-to-Order Service](#) on page [6](#), to enable 75 x 75mm and 100 x 100mm VESA applications.

4.3.2.1. Install VESA Bracket

Follow the guide below to install the VESA bracket to the computer:

1. Have the VESA-mount bracket, VMB-715 in this case, and the four mounting screws that come with it.



2. Place the computer on a flat surface, with the rear facing up.

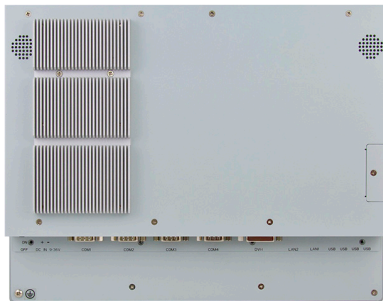

3. Place the VESA bracket onto the computer. Note that its installation direction should not block CFast card door.

VMB-715

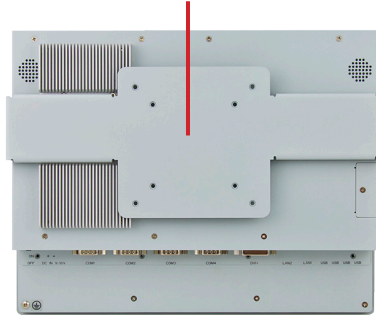

4. Fix the VESA bracket to the computer by two screws at each the left and right side of the computer.



Use another two screws on the left side.



Use two screws on the right side.

4.3.2.2. Use VESA Arm

To integrate the computer to a VESA arm:

1. Install the VESA-mount bracket to the computer as described in previous section.
2. Find the VESA mounting holes on the bracket.

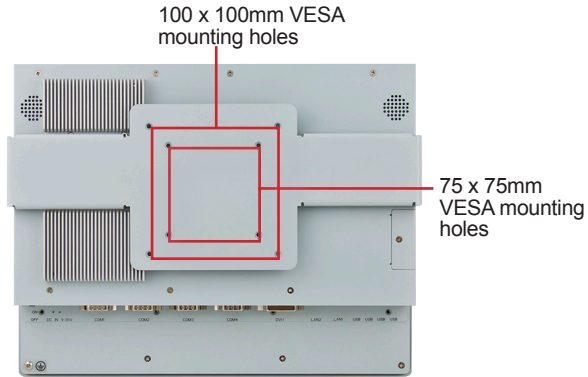

3. Attach the VESA arm to the rear of the computer by meeting the mounting holes on the VESA arm and VESA bracket.
4. Fix the assemblage with four screws.

VESA compliant arm

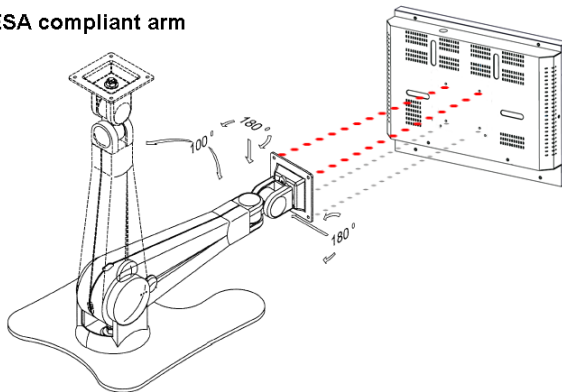

4.4. Wire DC-Input Power Source



Warning Only trained and qualified personnel are allowed to install or replace this equipment.

Follow the instructions below to connect the computer to a DC-input power source:

1. Before wiring, make sure the power source is disconnected.
2. Find the terminal block in the accessory box.
3. Use the wire-stripping tool to strip a short insulation segment from the output wires of the DC power source.
4. Identify the positive and negative feed positions for the terminal block connection.
5. Insert the exposed wires into the terminal block plugs. Only wires with insulation should extend from the terminal block plugs. Note that the polarities between the wires and the terminal block plugs must be positive to positive and negative to negative.
6. Use a slotted screwdriver to tighten the captive screws. Plug the terminal block firmly, which wired, into the receptacle on the rear panel.

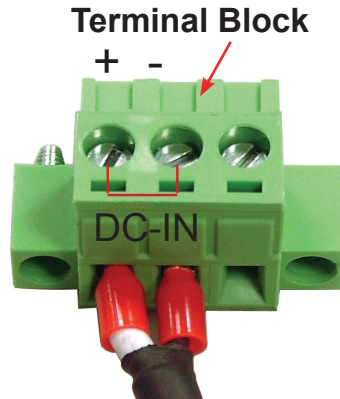
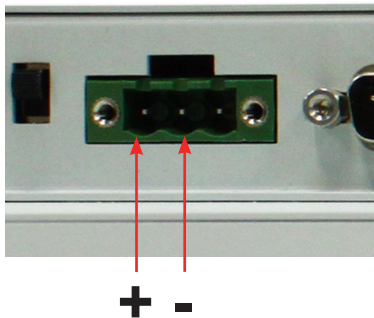

Chapter 5

BIOS

BIOS

The BIOS Setup utility for the computer is to configure the system settings stored in the system's BIOS ROM. The BIOS is activated once the computer powers on. When the computer is off, the battery on the main board supplies power to BIOS RAM.

To enter the BIOS Setup utility, keep hitting the "Esc" key upon powering on the computer.

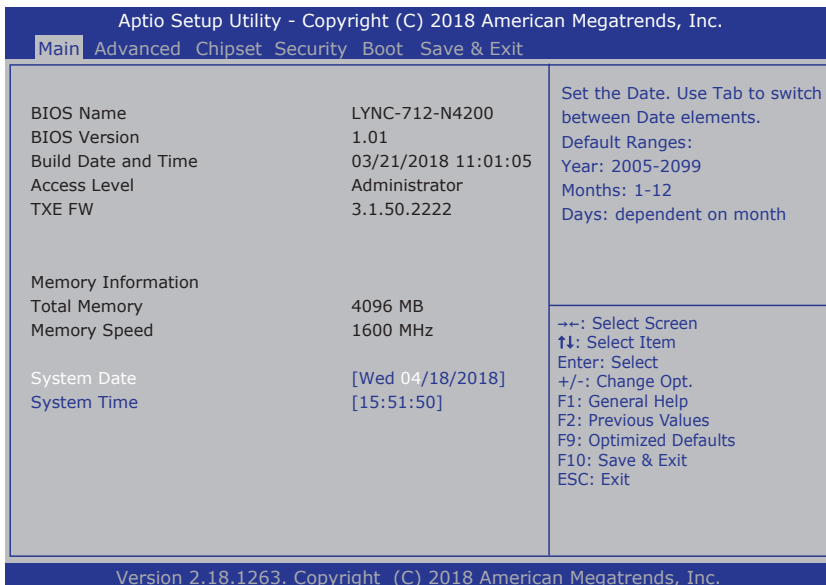

The BIOS featured menus are:

Menu	Description
Main	See 5.1. Main on page 40 .
Advanced	See 5.2. Advanced on page 41 .
Security	See 5.4. Security on page 50
Boot	See 5.5. Boot on page 51
Exit	See 5.6. Exit on page 52 .

Key Commands

The BIOS Setup utility relies on a keyboard to receive user's instructions. Hit the following keys to navigate within the utility and configure the utility.

Keystroke	Function
← →	Moves left/right between the top menus.
↓ ↑	Moves up/down between highlight items.
Enter	Selects an highlighted item/field.
+ -	Change options.
Esc	<ul style="list-style-type: none"> ▶ On the top menus: Use Esc to quit the utility without saving changes to CMOS. (The screen will prompt a message asking you to select OK or Cancel to exit discarding changes. ▶ On the submenus: Use Esc to quit current screen and return to the top menu.
F1	Opens the Help of the BIOS Setup utility.
F2	Previous values.
F9	Restore the Setup Default (The screen then prompts a message asking you to select OK or Cancel to restore to default.)
F10	Exits the utility saving the changes that have been made. (The screen then prompts a message asking you to select OK or Cancel to exit saving changes.)

Note: Pay attention to the “WARNING” that shows at the left pane onscreen when making any change to the BIOS settings.

This BIOS Setup utility is updated from time to time to improve system performance and hence the screenshots hereinafter may not fully comply with what you actually have onscreen.

5.1. Main

The **Main** menu features the settings of **System Date** and **System Time** and displays some BIOS info and system info.

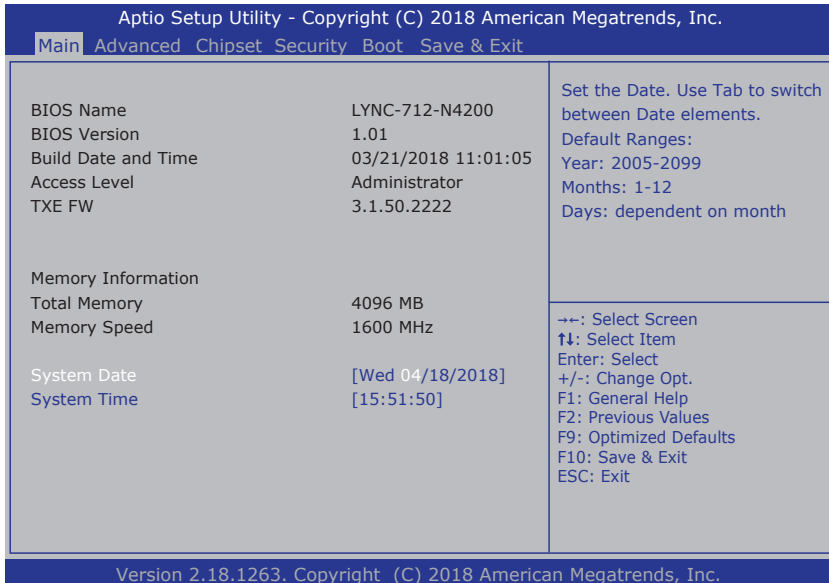

Setting	Description
BIOS Name	Delivers the model name of the computer.
BIOS Version	Delivers the computer's BIOS version.
Build Date and Time	Delivers the date and time when the BIOS Setup utility was made/ updated.
Access Level	Delivers the level that the BIOS is being accessed at the moment.
TXE FW	Delivers the firmware version.
Memory Information	Delivers the total memory and memory speed information.
System Date	Sets system date.
System Time	Sets system time.

5.2. Advanced

Access the **Advanced** menu to manage the computer's system configuration including the Super IO chip.

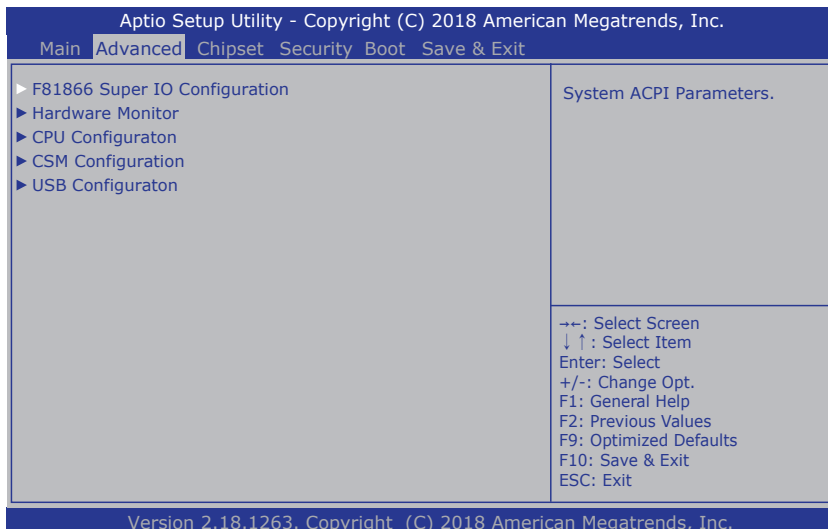

The featured settings and submenus are:

Setting	Description
F81866 Super IO Configuration	See 5.2.1. F81866 Super IO Configuration on page 42
Hardware Monitor	See 5.2.2. Hardware Monitor on page 44
CPU Configuration	See 5.2.3. CPU Configuration on page 45
CSM Configuration	See 5.2.4. CSM Configuration on page 45
USB Configuration	See 5.2.5. USB Configuration on page 46

5.2.1. F81866 Super IO Configuration

Setting	Description
Serial Port 1/2 Configuration	
Serial Port	Enable (default) or Disable Serial Port (COM).
Change Settings	Select an optimal setting for Super IO device. ▶ Auto ; IO=2F8h; IRQ=3 (default for Serial Port 1); IO=3F8h; IRQ=10, 11, 12, 15 (default for Serial Port 2); IO=2F8h; IRQ=10, 11, 12, 15 ; IO=3E8h; IRQ=10, 11, 12, 15 ; IO=2E8h; IRQ=10, 11, 12, 15 ;
Mode Select	Select RS-232 (default) or RS-485
Serial Port 3/4 (Ch A/B) Mode Select	Select RS-232 (default) or RS-485 After configuring the port to RS-485, you also need to configure the COM port settings in Windows. See next section for details.

Note: To configure COM 3&4 to RS-485, you need to set the COM port type to RS-485 in BIOS and configure the port settings in Windows OS. Please follow the steps as below to set up.

5.2.6.1 COM3&4 RS-485 Configuration in Windows

1. Right-click the **Start** button, then select **Device Manager** from the context menu..
2. Click **Ports (COM & LPT)** to open the list.

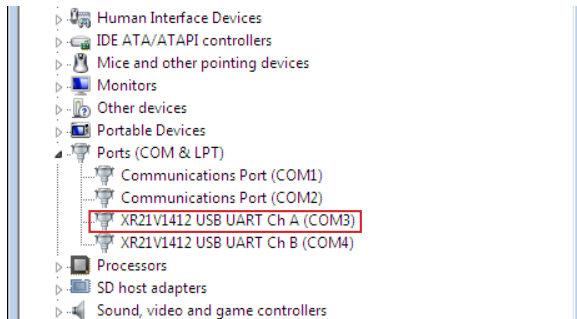

- Right-click on the **XR21V1412 USB UART Ch A (COM3)** or **XR21V1412 USB UARhT Ch B (COM4)** and then click **Property** from the context menu.
- Select the **Port Settings** tab and check the **RS-485** checkbox to enable it.

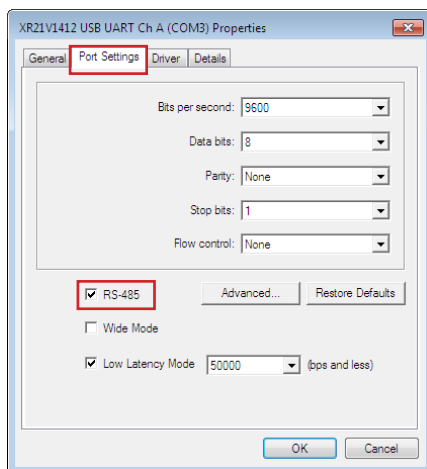

- Reboot the PC to enable the setting.

5.2.6.2 COM3&4 Port Number in Windows

Note: Based on the hardware design, **USB UART Ch A** always refers to **COM3** while **Ch B** refers to **COM4**. If you find the COM port numbers in reverse order in Windows Device Manager, please ignore it. It doesn't affect actual port assignment of the COM ports.

5.2.2. Hardware Monitor

Select this submenu to view the main board's hardware status. Select it to run a report of various info as depicted below:

The screenshot shows the 'Advanced' submenu of the Aptio Setup Utility. It is divided into two main sections. The left section, titled 'Pc Health Status', lists various system metrics and their current values. The right section, titled 'Enable/Disable CSM Support', contains a single option and a list of navigation instructions.

Pc Health Status		Enable/Disable CSM Support.
CPU Temperature	: +39°C	→←: Select Screen ↓↑: Select Item Enter: Select +/-: Change Opt. F1: General Help F2: Previous Values F9: Optimized Defaults F10: Save and Exit ESC: Exit
System Temperature	: +40°C	
+V3.3S	: +3.344 V	
+V5A	: +4.961 V	
+V5S	: +4.961 V	
+V12S	: +11.792 V	
VCC3V	: +3.344 V	
VS3V	: +3.344 V	
VS5V	: +5.012 V	
VBAT	: +3.027 V	

Version 2.18.1263. Copyright (C) 2018 American Megatrends, Inc.

5.2.3. CPU Configuration

Setting	Description
Socket 0 CPU Information	Display Socket specific CPU Information.
EIST	Enables/disables Intel SpeedStep ▶ Enabled is the default.
Turbo Mode	Enables/disables Turbo Mode ▶ Enabled is the default.
Boot performance mode	Select the performance state that the BIOS will set before OS handoff. ▶ Options: Max performance (default), Max Battery
C-States	Enables/disables C states. ▶ Enabled is the default.

5.2.4. CSM Configuration

Setting	Description
CSM Support	Enable and Disable CSM Support ▶ Enabled is the default.
CSM16 Module Version	Shows the CSM16 module version.
Boot option filter	Controls Legacy/UEFI ROMs priority. ▶ Options: UEFI and Legacy (default), Legacy only and UEFI only
Network	Control the execution of UEFI and Legacy PXE OpROM. ▶ Options: Do not launch (default), UEFI and Legacy .
Storage	Control the execution of UEFI and Legacy Storage OpROM. ▶ Options: Do not launch and Legacy (default).
Video	Control the execution of UEFI and Legacy Video OpROM. ▶ Options: Do not launch , UEFI and Legacy (default).

5.2.5. USB Configuration

Setting / Info	Description
Legacy USB Support	<p>Enables/disables legacy USB support.</p> <ul style="list-style-type: none"> ▶ Options available are Enabled (default), Disabled and Auto. ▶ Select Auto to disable legacy support if no USB device are connected. ▶ Select Disabled to keep USB devices available only for EFI applications.
XHCI Hand-off	<p>Enables/disables a workaround for the operating systems that have no XHCI hand-off support</p> <ul style="list-style-type: none"> ▶ Enabled is the default.
USB Mass Storage Driver Support	<p>Enables/disables the support for USB mass storage driver.</p> <ul style="list-style-type: none"> ▶ Enabled is the default.
USB transfer time-out	<p>The time-out value for Control, Bulk and Interrupt transfers.</p> <ul style="list-style-type: none"> ▶ Options: 1/5/10/20 sec (default)
Device reset time-out	<ul style="list-style-type: none"> ▶ USB mass storage device Start Unit command time-out. ▶ Options: 10/20 (default)/30/40 sec
Device power-up delay	<p>Maximum time the device will take before it properly reports itself to the Host Controller. 'Auto' uses default value: for a Root port it is 100 ms, for a Hub port the delay is taken from Hub descriptor.</p> <ul style="list-style-type: none"> ▶ Options: Auto (default), Manual

5.3. Chipset

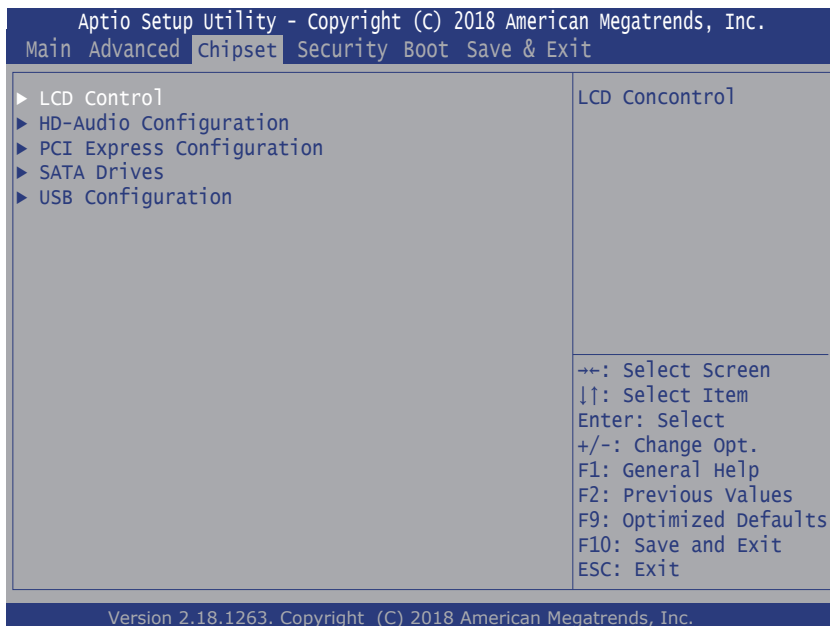

Setting	Description
LCD Control	See 5.3.1 LCD Control on page 48
HD-Audio Configuration	See 5.3.2 HD-Audio Configuration on page 48
PCI Express Configuration	See 5.3.3 PCI Express Configuration on page 48
SATA Drives	See 5.3.4 SATA Drives on page 49
USB Configuration	See 5.3.5 USB Configuration on page 49

5.3.1 LCD Control

Setting	Description
Primary IGFX Boot Display	Select the video device which will be activated during POST. This has no effect if external graphics present. Secondary boot display selection will appear based on your selection. VGA modes will be supported only on primary display. ▶ Options: Auto (default), EFP and LFP .

5.3.2 HD-Audio Configuration

Item	Description
HD-Audio Support	Enable/disable HD-Audio Support. ▶ Options: Disabled and Enabled (default).

5.3.3 PCI Express Configuration

Item	Description
PCI Express Root Port 1/2/3/4/5/6	Control the PCI Express Root Port. ▶ Options: Auto (default): To disable unused root port automatically for the most optimum power savings. Enable : Enable PCIe root port Disable : Disable PCIe root port
ASPM	PCI Express Active State Power Management settings. ▶ Options: Disabled (default), L0s , L1 , L0sL1 and Auto
PCIe Speed	Configure PCIe Speed. CHV A1 always with Gen1 speed. ▶ Options: Auto (default), Gen 2 and Gen 1

5.3.4 SATA Drives

Item	Description
Chipset SATA	Enables or disables the chipset SATA controller. ▶ Options: Enabled (default) and Disabled
Port 0/1	Enables or disables the SATA port ▶ Options: Enabled (default) and Disabled
SATA Device Type	Identify the SATA port is connected to Solid State Drive or Hard Disk Drive. ▶ Options: Hard Disk Drive (default) and Solid State Drive .

5.3.5 USB Configuration

Item	Description
XHCI Mode	Enable (default) or Disable XHCI Mode.
USB Port Disable Override	Selectively enable/disable the corresponding USB port from reporting a device connection to the controller. ▶ Options: Disabled (default) and Enabled .

5.4. Security

The **Security** menu sets up the password for the system’s supervisor account. Once the supervisor password is set up, this BIOS Setup utility is limited to access and will ask for the password each time any access is attempted.

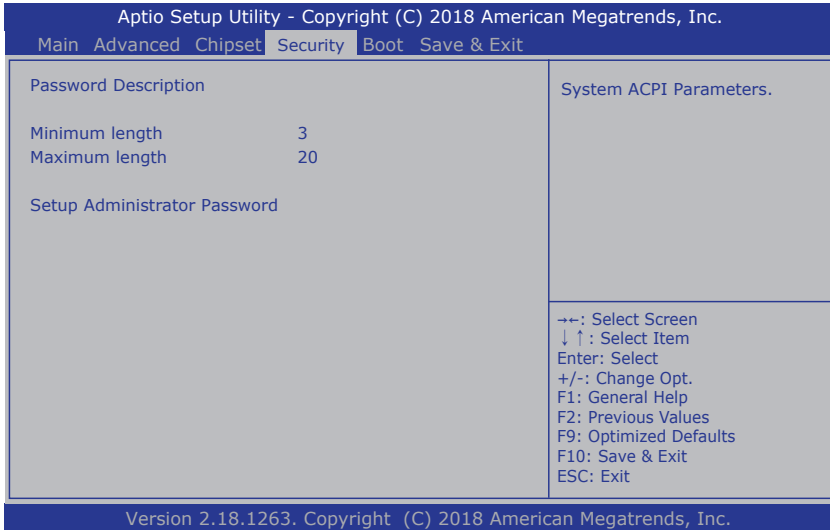

The featured setting is:

Setting	Description
Setup Administrator Password	<p>To set up an administrator password:</p> <ol style="list-style-type: none"> 1. Select Set Administrator Password. 2. An Set Administrator Password dialog then pops up onscreen. 3. Enter your desired password that is no less than 3 characters and no more than 20 characters. 4. Hit [Enter] key to submit.

5.5. Boot

The **Boot** menu configures how to boot up the system such as the configuration of boot device priority.

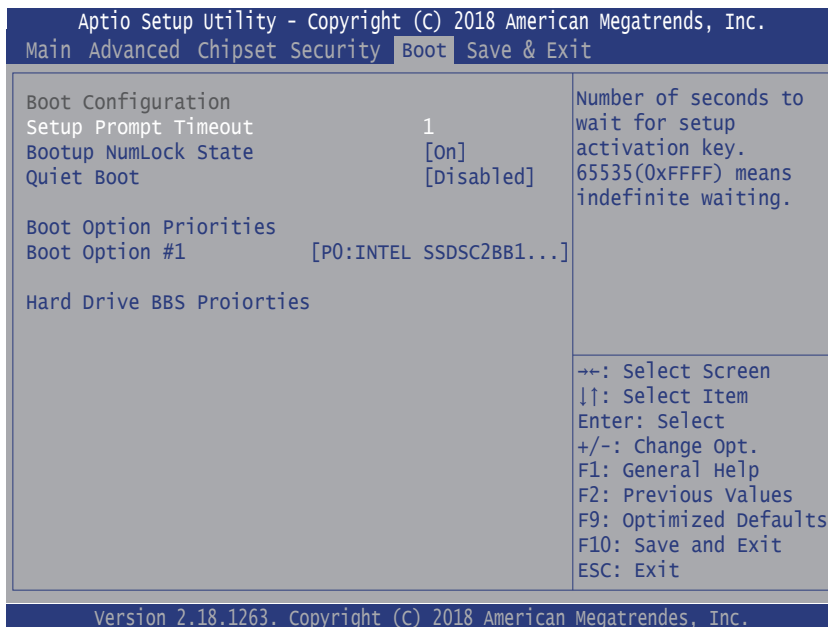

Setting	Description
Setup Prompt Timeout	Number of seconds to wait for setup activation key. 65535(0xFFFF) means indefinite waiting.
Boot NumLock State	Select the keyboard NumLock state. ▶ Options: On (default) and Off .
Quiet Boot	Enable (default) or Disable Quiet Boot option.
Boot Option Priorities	Sets the boot priority among the available device types.

5.6. Exit

The **Exit** menu features a handful of commands to launch actions from the BIOS Setup utility regarding saving changes, quitting the utility and recovering defaults.

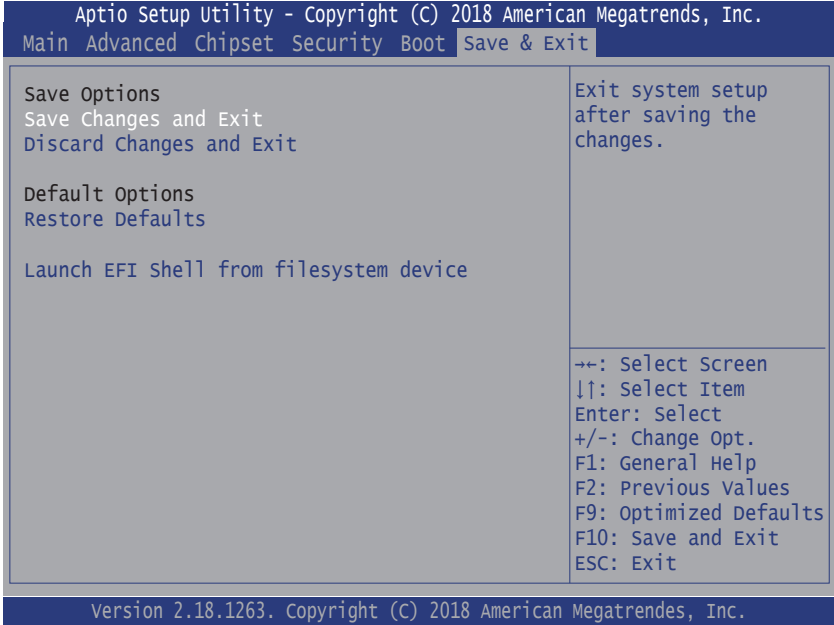

Setting	Description
Save Changes and Exit	Exit system setup after saving the changes. ▶ Enter the item and then a dialog box pops up: Save configuration and exit? (Yes/ No)
Discard Changes and Exit	Exit system setup without saving the changes. ▶ Enter the item and then a dialog box pops up: Quit without saving? (Yes/ No)
Restore Defaults	Restore/Load Default values for all the setup options. ▶ Enter the item and then a dialog box pops up: Load Optimized Defaults? (Yes/ No)
Launch EFI Shell from filesystem device	Attempts to launch EFI shell application (Shell.efi) from one of the available filesystem devices.

Appendices

Appendix A: WIFI-AT4550 Hardware Installation

This appendix will guide you to install the Wi-Fi module WIFI-AT4550.

A.1. Install WIFI-AT4550

1. Loosen and remove the screws from the computer's rear panel.

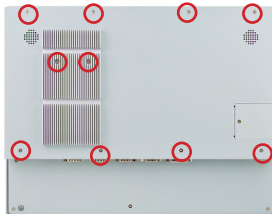

LYNC-715-4200G4

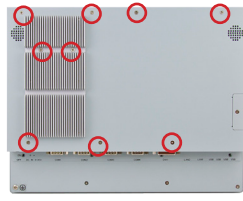

LYNC-712-4200G4

2. Loosen and remove the 4 screws from each of the left and right side respectively.



3. Dismount the rear cover from the computer. The inside of the computer comes to view. Locate the mini-card socket for WiFi module installation.

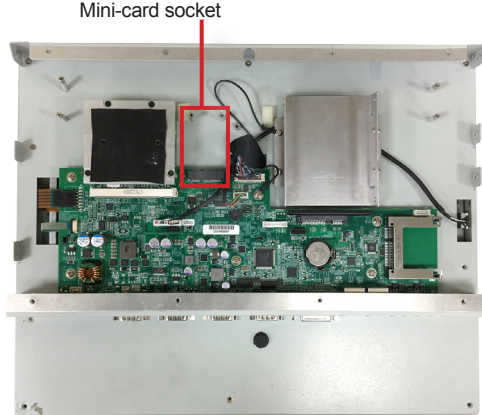

4. In order to make the half-size Wi-Fi module compatible with the Mini-card socket, extend the WiFi module with a "mini half bracket". Join them together

by using two screws.

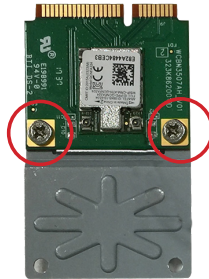

5. Connect the RF antenna's MHF connector to the Wi-Fi module.

Connect the RF antenna's MHF connector to the Wi-Fi module's main connector

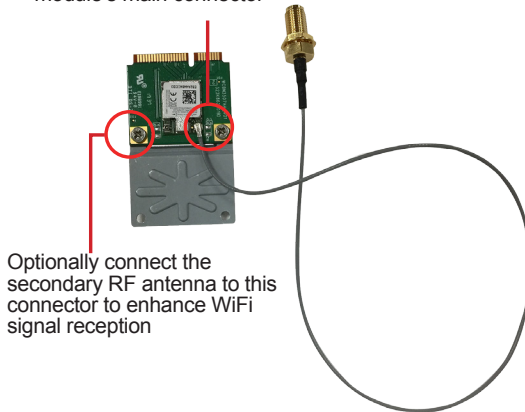

Optionally connect the secondary RF antenna to this connector to enhance WiFi signal reception

6. Plug the WIFI-AT4550 into the Mini-card socket by a slanted angle. Fully plug the module, and note the notch on the Wi-Fi module should meet the break on the connector.
Press down the module and fix the module in place using two screws.

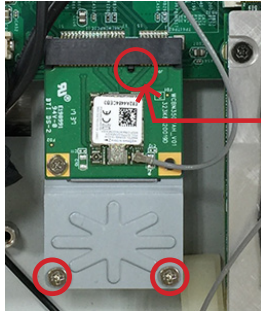

The notch on the Wi-Fi module should meet the break on the connector.

7. From the SMA end of the RF antenna, remove the washer and the nut. Save the washer and nut for later use. Note that the SMA connector is in the form of a threaded bolt, with one flat side.

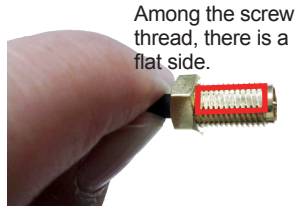
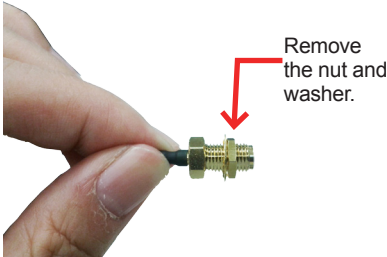

8. Remove the plastic plug from the antenna hole. Keep the plastic plug for any possible restoration in the future.



Remove the plug to access the antenna hole

9. Pass the SMA connector through the above mentioned antenna hole. Make sure that you align the connector's flat side with the antenna hole's flat side.

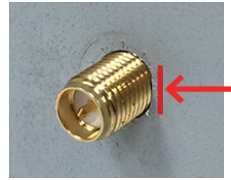
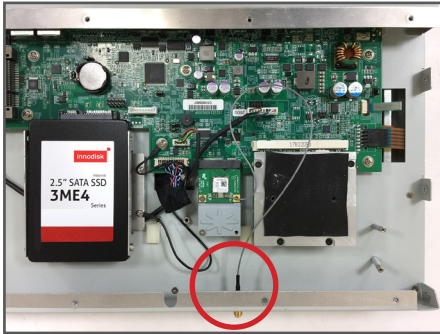

Arrange the flat side of the SMA connector to meet the flat side of the antenna hole.

10. Mount the washer first and then the nut to the SMA connector. Make sure the nut is tightened.



Mount the washer and the nut to the SMA connector. Tighten the nut.

11. If you are using two antennas, repeat steps above for another antenna.
12. Restore the rear panel to the computer. Have an external antenna. Screw and tightly fasten the antenna to the SMA connector. Swivel the antenna to an angle of best signals.

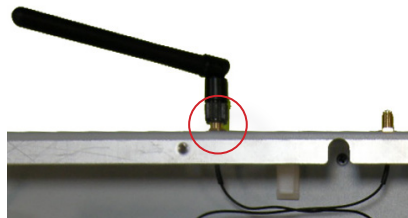

Appendix B: PenMount Utilities

B.1. PenMount Control Panel

After everything is installed properly, there will be a touch screen application named **PenMount Control Panel** in **All Programs**. Execute this application.

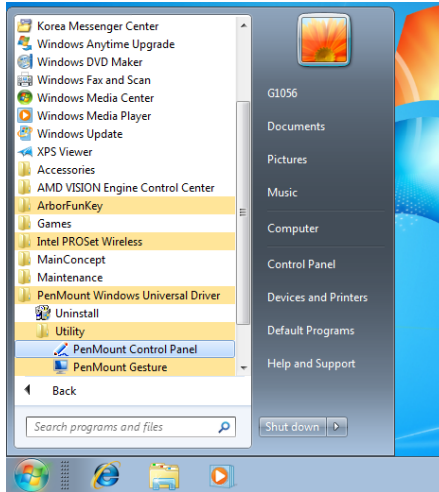

1. The program consists of 3 tabs. The left one is **Device**, in it, you can find how many devices are detected in your system. Select one device icon and tap **Configure**, or double tap the device icon for touch screen calibration.

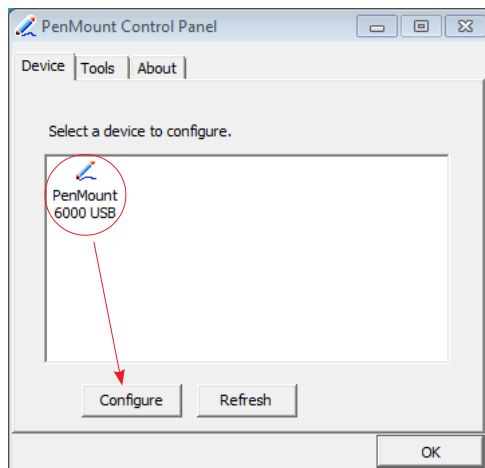

2. And then another window with **Calibrate** tab will jump out.

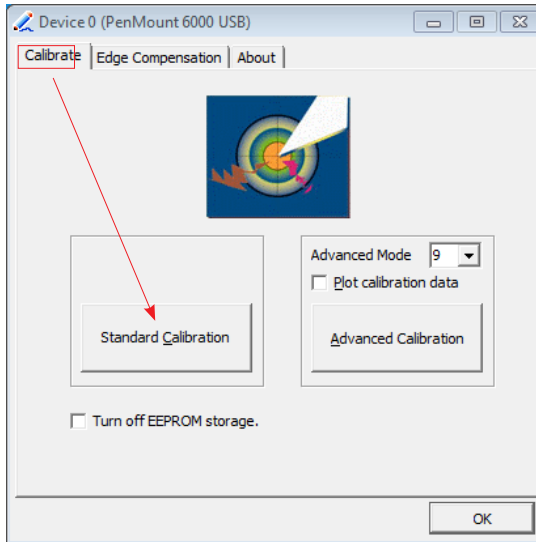

Device Calibration Dialog

a. The Calibrate Tab

This function offers two ways to calibrate your touch screen. ‘**Standard Calibration**’ adjusts most touch screens while ‘**Advanced Calibration**’ adjusts aging touch screens.

a.1 Standard Calibration

The Standard Calibration function lets you match the touch screen to your display so that the point you touch is accurately tracked on screen. Standard Calibration only requires four points for calibration and one point for confirmation. Under normal circumstance, Standard Calibration is all you need to perform an accurate calibration.

- i. Please tap the Standard Calibration button to start calibration procedures.
- ii. After that, the 1st crosshair will appear on white screen. Use your finger or stylus to touch the red center and hold down until the screen shows the message - “Lift off to proceed”.
- iii. The 2nd crosshair follows immediately. Do the process again. After the fifth red point calibration is complete, the program will jump out automatically, or you may press ESC key to quit it during calibration process. Alternatively, doing nothing for a while equates to pressing ESC.

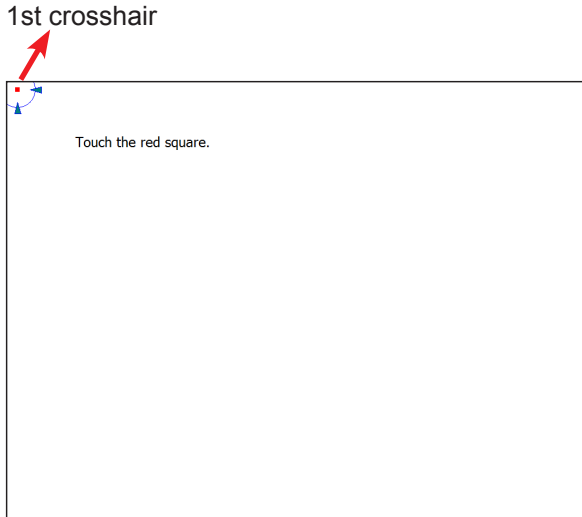

a.2 Advanced Calibration

The Advanced Calibration function improves the accuracy of calibration by using more involved engineering calculations. Use this function only if you have tried the Standard Calibration and there is still a discrepancy in the way the touch screen maps to the display. You can choose 9, 16 or 25 points to calibrate, though we suggest that you first try 9 points, if it is still not tracking well then try 16 or 25 points. The more points you use for calibration, the greater the accuracy is. Errors in calibration may occur due to viewing angle, or individual skill, and there may be little difference in using 16 or 25 points. Note that a stylus is recommended for most accurate results.

Plot Calibration Data

Check this function to have touch panel linearity comparison graph appear when you finish Advanced Calibration. The black lines reflect the ideal linearity assumed by PenMount's application program while the blue lines show the approximate linearity calculated by PenMount's application program as the result of user's execution of Advance Calibration.

Turn off EEPROM storage

Tick this function to disable the write-in of calibration data in Controller.

Please tap the Advanced Calibration button to start calibration procedures and do the rest as explained in Standard Calibration.

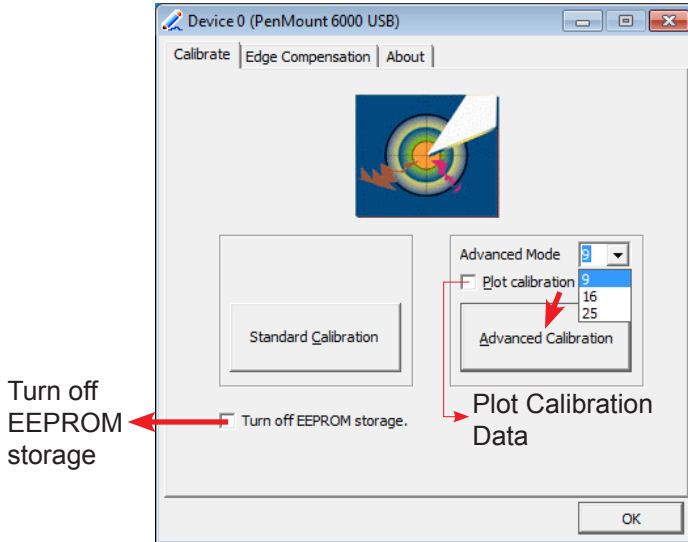

b. The Edge Compensation Tab

Under the same level where you calibrate your screen, you may find the tab. This tab is the edge compensation settings for the advanced calibration. You can adjust the settings from 0 to 30 for accommodating the difference of each touch panel.

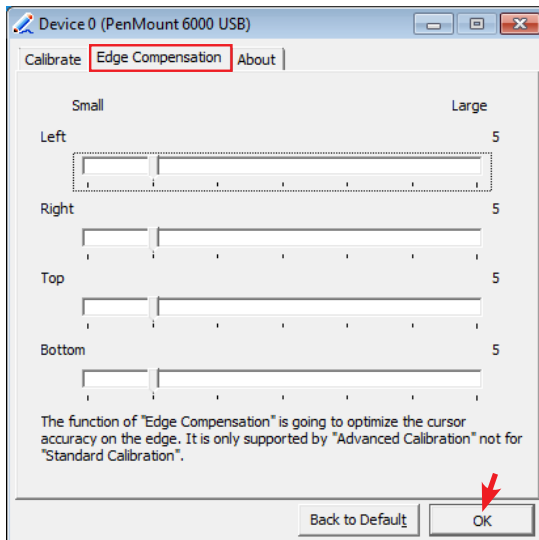

3. Press **OK** to close former window and back to upper level. As mentioned before, the program consists of 3 tabs, and the central one is **Tool**, switch to it and click **Draw** to test PenMount touch screen operation.

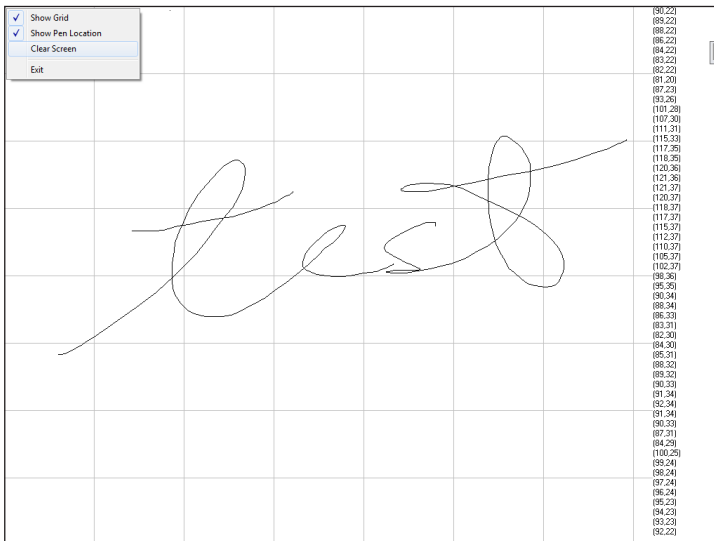
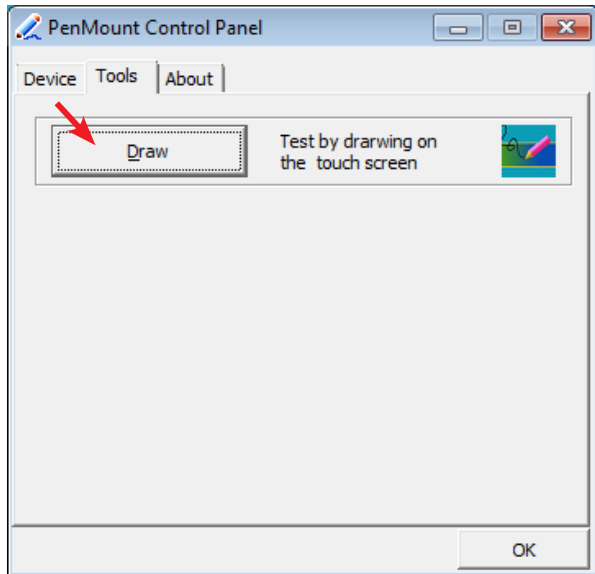

B.2. PenMount Gesture

1. Now that this tablet PC supports touchscreen function, you may take advantage of that to set hotkey or do other settings. Single-click a small icon like a monitor in system tray. If it's absent, you can recall it from **All Programs**. The default setting is inactive, so you need to click "Gesture Setting" to start the program.

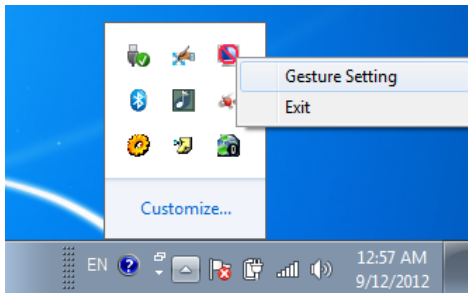
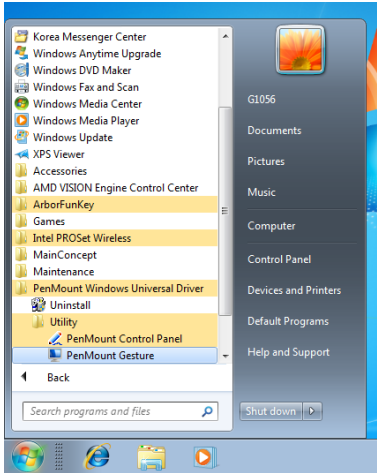

2. Check “Enable” and click the upward arrow in red square. You may also disable gesture function by canceling “Enable” box.

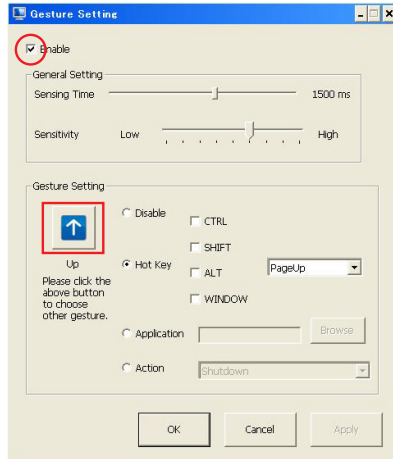

3. And then another **Gesture Select** window will pop up. Each mark in this menu represents your gesture on screen. For example, the upward arrow indicates that you move your finger across the touch screen from bottom to top. The rest are similar. You may use your gesture applied on the touchscreen to do further configuration. Select a gesture you would like to define.

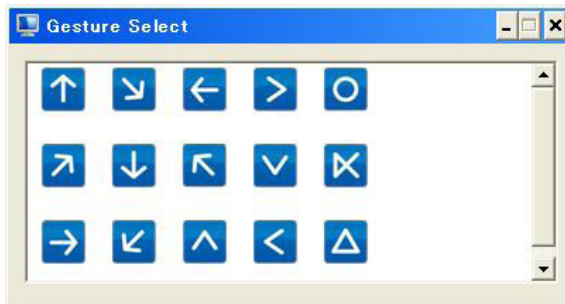

4. Then again, choose **Hot Key**, **Action** or **Application** to set each gesture's corresponding function. You may disable respective gesture, too. And remember to press **Apply** after all.

