

QBiX-PPC-215A310HT-A1 (PS-H310A-SI)

21.5" Industrial Panel PC System
Quick Start Guide

Copyright Notice

This document is copyrighted, 2022. All rights are reserved. The original manufacturer reserves the right to make improvements to the products described in this manual at any time without notice.

No part of this manual may be reproduced, copied, translated, or transmitted in any form or by any means without the prior written permission of the original manufacturer. Information provided in this manual is intended to be accurate and reliable. However, the original manufacturer assumes no responsibility for its use, or for any infringements upon the rights of third parties that may result from its use.

The material in this document is for product information only and is subject to change without notice. While reasonable efforts have been made in the preparation of this document to assure its accuracy, GIGAIPC assumes no liabilities resulting from errors or omissions in this document, or from the use of the information contained herein.

GIGAIPC reserves the right to make changes in the product design without notice to its users.

Acknowledgement

All other products' name or trademarks are properties of their respective owners.

- AMD is trademark of Advanced Micro Devices.
- Microsoft Windows is a registered trademark of Microsoft Corp.
- Intel, Pentium, Celeron, and Xeon are registered trademarks of Intel Corporation
- Core, Atom are trademarks of Intel Corporation
- ITE is a trademark of Integrated Technology Express, Inc.
- IBM, PC/AT, PS/2, and VGA are trademarks of International Business Machines Corporation.

All other product names or trademarks are properties of their respective owners.

Packing List

Before setting up your product, please make sure the following items have been shipped:

Item	Quantity
System kit	1
Screw for 2.5" HDD M3x4L (25984G-1C014-S00)	8
CPU Cooler (25ST0-538784-Y0R)	1

If any of these items are missing or damaged, please contact your distributor or sales representative immediately.

About this Document

This User's Manual contains all the essential information, such as detailed descriptions and explanations on the product's hardware and software features (if any), its specifications, dimensions, jumper/connector settings/definitions, and driver installation instructions (if any), to facilitate users in setting up their product.

Users may refer to the GIGAIPC.com for the latest version of this document.

Safety Precautions

Please read the following safety instructions carefully. It is advised that you keep this manual for future references

1. All cautions and warnings on the device should be noted.
2. Make sure the power source matches the power rating of the device.
3. Position the power cord so that people cannot step on it. Do not place anything over the power cord.
4. Always completely disconnect the power before working on the system's hardware.
5. No connections should be made when the system is powered as a sudden rush of power may damage sensitive electronic components.
6. If the device is not to be used for a long time, disconnect it from the power supply to avoid damage by transient over-voltage.
7. Always disconnect this device from any AC supply before cleaning.
8. While cleaning, use a damp cloth instead of liquid or spray detergents.
9. Make sure the device is installed near a power outlet and is easily accessible.
10. Keep this device away from humidity.
11. Place the device on a solid surface during installation to prevent falls
12. Do not cover the openings on the device to ensure optimal heat dissipation.

13. Watch out for high temperatures when the system is running.
14. Do not touch the heat sink or heat spreader when the system is running
15. Never pour any liquid into the openings. This could cause fire or electric shock.
16. As most electronic components are sensitive to static electrical charge, be sure to ground yourself to prevent static charge when installing the internal components. Use a grounding wrist strap and contain all electronic components in any static-shielded containers.
17. If any of the following situations arises, please the contact our service personnel:
 - i. Damaged power cord or plug
 - ii. Liquid intrusion to the device
 - iii. Exposure to moisture
 - iv. Device is not working as expected or in a manner as described in this manual
 - v. The device is dropped or damaged
 - vi. Any obvious signs of damage displayed on the device
- 18. DO NOT LEAVE THIS DEVICE IN AN UNCONTROLLED ENVIRONMENT WITH TEMPERATURES BEYOND THE DEVICE'S PERMITTED STORAGE TEMPERATURES (SEE CHAPTER 1) TO PREVENT DAMAGE.**

FCC Statement

Warning!



This device complies with Part 15 FCC Rules. Operation is subject to the following two conditions: (1) this device may not cause harmful interference, and (2) this device must accept any interference received including interference that may cause undesired operation.

Caution:

There is a danger of explosion if the battery is incorrectly replaced. Replace only with the same or equivalent type recommended by the manufacturer. Dispose of used batteries according to the manufacturer's instructions and your local government's recycling or disposal directives.

Attention:

Il y a un risque d'explosion si la batterie est remplacée de façon incorrecte. Ne la remplacer qu'avec le même modèle ou équivalent recommandé par le constructeur. Recycler les batteries usées en accord avec les instructions du fabricant et les directives gouvernementales de recyclage.

High Temperature Warning

(1) This equipment is intended to be used in Restrict Access Location. The access can only be gained by Skilled person or by Instructed person who have been instructed about the metal chassis of the equipment is so hot that Skilled person have to pay special attention or take special protection.

Only authorized by well trained professional person can access the restrict access location.

(2) External metal parts are hot!! Before touching it, special attention or protection is necessary



Table Contents

21.5” Industrial Panel PC System	1
Quick Start Guide	
Copyright Notice	2
Acknowledgement	3
Packing List.....	4
About this Document.....	5
Safety Precautions	6
FCC Statement.....	8
High Temperature Warning	8
Chapter 1 - Product Specifications	13
1.1 Specifications	15
Chapter 2 – QBiX-PPC-215A310HT-A1	17
Industrial Panel PC System Kit	
2.1 Dimension	18
2.2 Getting Familiar with Your Unit.....	19
2.3 A) Memory Installation: DDR4 SO-DIMM	21
2.4 B) Wireless Module: How to safely install the Module (Wireless Module inclusion may vary based on local distribution)	22
2.5 C) 2.5” HDD/SSD installation	23
2.6 D) M.2 SSD Installation: How to safely install the M.2 2280/2242 SSD.....	24

2.7	CPU Installation.....	25
2.8	Antenna Installation (Antenna inclusion may vary based on local distribution)	26
2.9	Cable Pin-define	27
2.10	Support	28
2.11	Safety and Regulatory Information.....	29

Chapter 3 – Hardware Information 30

3.1	Jumpers and Connectors	31
3.2.1	FP_AUDIO (Front audio header).....	35
3.2.2	SPKR (Speaker out Connector).....	36
3.2.3	BATTERY (Battery cable connector).....	37
3.2.4	EDP (Embedded Display Port Connector).....	38
3.2.5	LVDS (LVDS connector).....	39
3.2.6	LSW (LVDS resolution jumper)	40
3.2.7	JCOM11 (RI pin RI/5V/12V Select jumper for COM1 port)	41
3.2.8	JRS11-14 (RS-232/422/485 select jumper for COM1 port)	42
3.2.9	BKL_CN (Backlight Control connector)	43
3.2.10	DC_IN2 (ATX 2x2 pin power connector).....	44
3.2.11	COM4 (Serial Port header (RS-232))	45
3.2.12	COM3 (Serial Port header (RS-232)).....	46
3.2.13	SYS_FAN (System Fan Connector)	47

3.2.14	GPIO_CNT (General Purpose input/output header)	48
3.2.15	TPM (Trusted Platform Module Connector)	49
3.2.16	SATA_PWR1 (SATA Power Connector)	50
3.2.17	SATA1, SATA2 (SATA 6Gb/s Connector)	51
3.2.18	ATX_CTL (ATX Control header)	52
3.2.19	JCOM16 (RI pin RI/5V/12V select jumper for COM2 port)	53
3.2.20	CLR_CMOS (Clear CMOS Jumper)	54
3.2.21	JRS21-24 (RS-232/422/485 select jumper for COM2 port)	55
3.2.22	COM2 (Serial Port header (RS-232/422/485 & RI/5V/12V))	56
3.2.23	SYS_PANEL (Front Panel header)	57
3.2.24	FUSB2_1 (USB 2.0 header)	58
3.2.25	FUSB2_2 (USB 2.0 header)	59
3.2.26	CPU_FAN (CPU fan connector)	60
3.2.27	DC_IN1 (DC In JACK Connector)	61
3.2.28	COM1 (Serial port (RS-232/422/485 & RI/5V/12V))	62
3.2.29	AT_CN (AT/ATX mode select jumper)	63

Chapter 4 – BIOS 64

4.1	Introduction	65
4.2	The Main Menu	66
4.3	Advanced	67

4.3.1	TPM Configuration.....	68
4.3.2	IT8786 Super IO Configuration	70
4.3.3	Hardware Monitor	71
4.3.4	S5 RTC Wake Settings	72
4.3.5	CPU Configuration	73
4.3.6	SATA Configuration	74
4.3.7	CSM Configuration.....	75
4.3.8	AMI Graphic Output Protocol Policy.....	76
4.3.9	Digital IO Port Configuration	77
4.4	Chipset	78
4.5	Security	80
4.6	Boot.....	83
4.7	Save & Exit	84

Chapter 1

Chapter 1 - Product Specifications

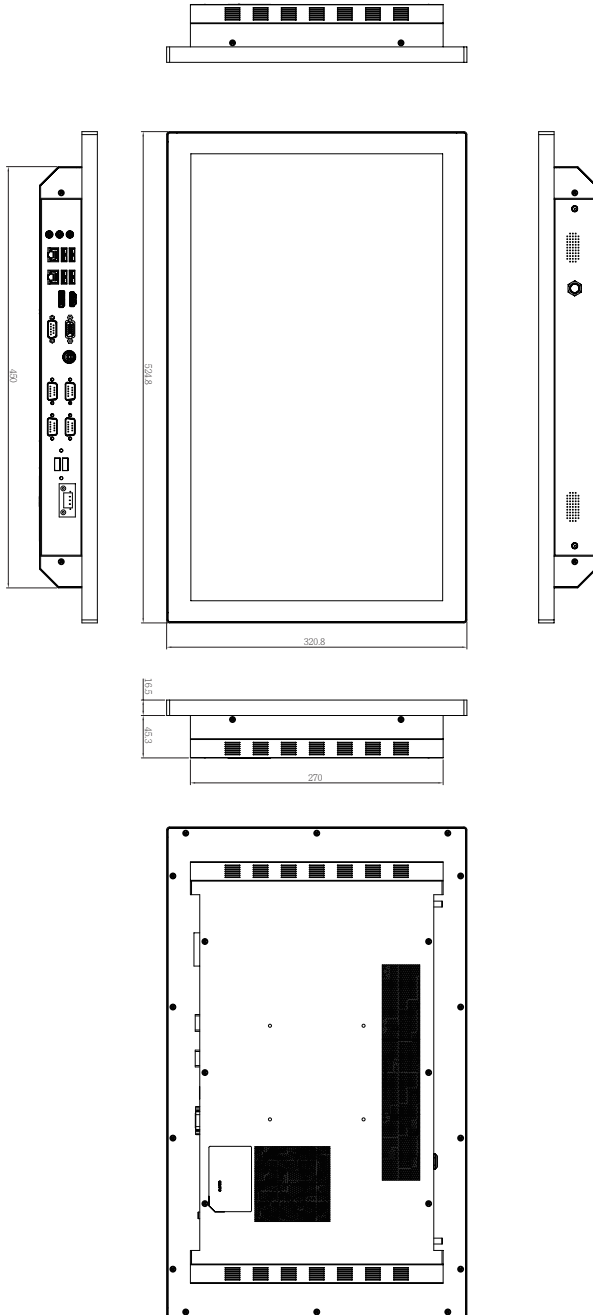

1.1 Specifications

System	QBiX-PPC-215A310HT-A1 (PS-H310A-SI)
Dimension	System Size : 524.8W x 61.8D x 320.8H (mm)
Motherboard	mITX-H310A
LCD	Display Type : 21.5" TFT LCD panel Resolution : 1920 x 1080 Brightness : 250 cd/m ² View angel : 160°/178° (H), 160°/178° (V) Contrast Ratio : 3000:1 Response time : 25 ms Backlight lifetime : 40,000 hrs
Touch screen	Type : 10 points, projected capacitive Viewing Area : 477.64L x 269.11W Active Area : 476.06L x 267.79W Surface Hardness : >=3H Transparency : >85%
CPU	Support for 9th/8th Generation Intel® Core™ i7/i5/i3, Pentium® and Celeron® processors in the LGA1151 package TDP under 35W
Memory	2 x DDR4 SO-DIMM sockets, Max. Capacity 32 GB Support Dual channel DDR4 2666/2400 MHz memory modules
Ethernet	2 x GbE LAN Ports (Intel® I219V & Intel® I211AT)
Expansion Slots	1 x 2280/2242 M.2 M-Key (SATA 6Gb/s) 1 x 2230 M.2 E-Key (WiFi/BT)
I/O	3 x Audio Jacks (Line in, Line out, Mic in) 1 x COM Port (RS-232/422/485 & RI/5V/12V) 3 x COM Ports (RS-232/422/485) 1 x 3-pin Terminal Block 1 x HDMI 1 x Display Port 1 x VGA 1 x GPIO (8 bits) 2 x RJ45 LAN Ports 4 x USB 3.2 Gen 1 2 x USB 2.0 1 x Power button with LED

System	QBIX-PPC-215A310HT-A1 (PS-H310A-SI)
Storage	2 x 2.5" HDD/SSD
Speaker	2 x 2W speaker
Power	+12V/+19V/+24VDC
Operation Temperature	Operating temperature: 0°C to 50°C Operating humidity: 0-90% (non-condensing) Non-operating temperature: -40°C to 70°C Non-operating humidity: 0%-95% (non-condensing) Use wide temperature range memory and storage
Vibration During Operation	Operation: IEC 60068-2-64, 1 Grms, random, 5 ~ 500 Hz, 1 hr / Per Axis, With SSD/M.2 2280 Non-operation: IEC 60068-2-6, 2 G, Sine, 10 ~ 500 Hz, 1 Oct/min, 1 hr / Per Axis
Shock During Operation	Operation: IEC 60068-2-27, 50 G, half sine, 11 ms duration, With SSD
Packaging Content	Carton size: 625 x 424 x 188 (mm) Packing Capacity: 1pc Including: Screw for 2.5" HDD M3x4L x 8 (P/N: 25984G-1C014-S00) CPU Cooler x 1 (P/N: 25ST0-538784-Y0R)
Order Information	System: 6BPSH310AMR-SI (Box packing)

Chapter 2

Chapter 2 – QBiX-PPC-215A310HT-A1 Industrial Panel PC System Kit

2.2 Getting Familiar with Your Unit

[Front Side]

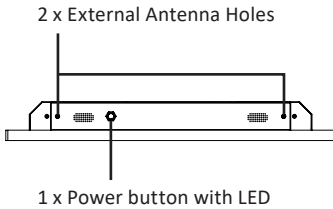

[Left Side]

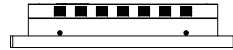

[Rear Side]

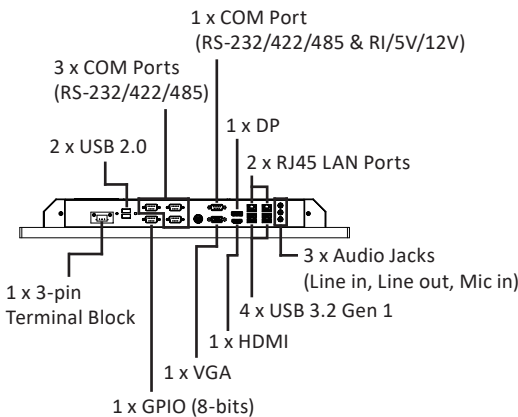

[Right Side]



[Install]

- * Before opening the case, make sure to unplug the power cord.
- * Before Connecting the power, make sure to fasten the case securely.

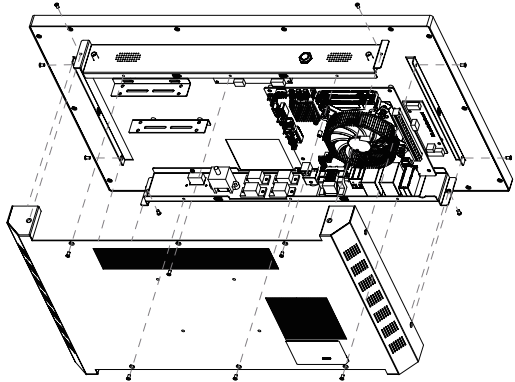
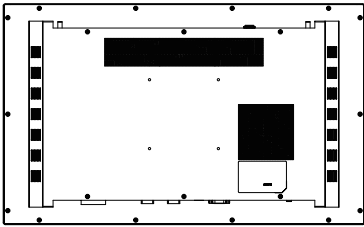

[Bottom PCB Side]

	Information
A	2 x DDR4 SO-DIMM sockets, DDR4 2666/2400 MHz, Max. Capacity 32 GB
B	1 x M.2 slot (Support NGFF-2230 WiFi/BT)

	Information
C	support 2 x 2.5" Hard drive/SSD
D	1 x M.2 slot (Support NGFF-2280/2242 SATA 6Gb/s)

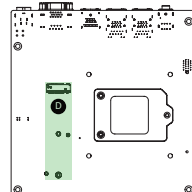
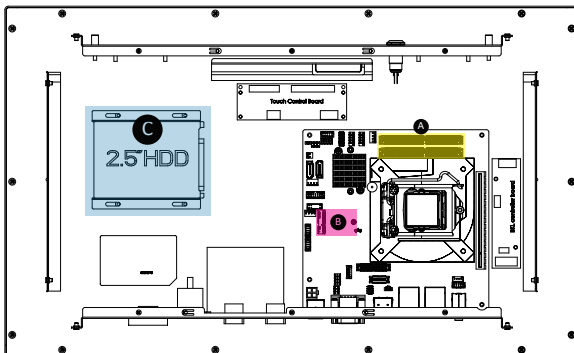

2.3 A) Memory Installation: DDR4 SO-DIMM

1

Carefully insert SO-DIMM memory modules into the SODIMM1 Slot.

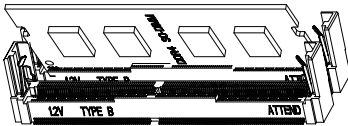

2

Push the memory and seat it firmly.

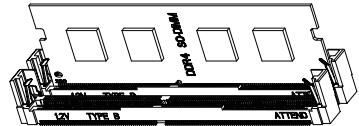

3

Carefully insert SO-DIMM memory modules into the SODIMM2 Slot.

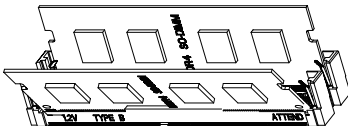

4

Push the memory and seat it firmly.

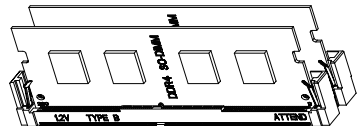

2.4 B) Wireless Module: How to safely install the Module (Wireless Module inclusion may vary based on local distribution)

1

Carefully insert the wireless module into the M.2 slot

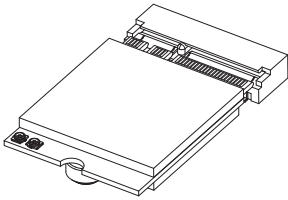

2

Lock the screw in the middle.

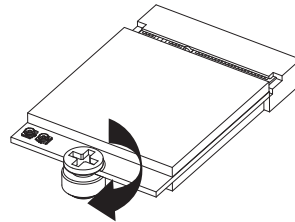

3

Install the antenna on the left side of the connection wireless module down.

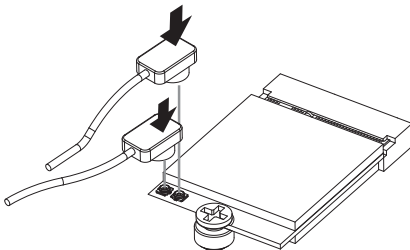

2.5 C) 2.5" HDD/SSD installation

1

Install 1st 2.5" HDD with 4 screws.

Torsion : 1.0~1.5 kgf-cm

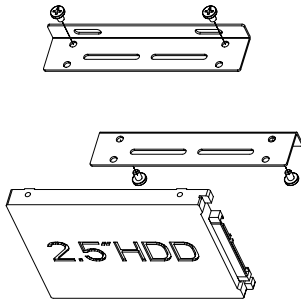
**2**

Install 2nd 2.5" HDD with 4 screws.

Torsion : 1.0~1.5 kgf-cm

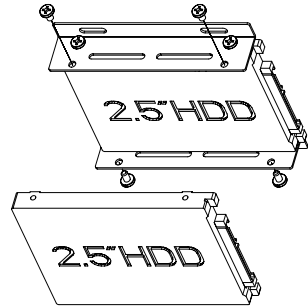

2.6 D) M.2 SSD Installation: How to safely install the M.2 2280/2242 SSD

1

Loosen 4 screws to disassemble the motherboard.

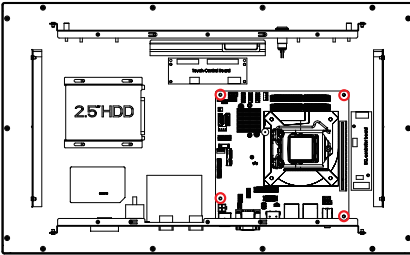

2

Find the M.2 M-Key slot on the bottom side of Motherboard.

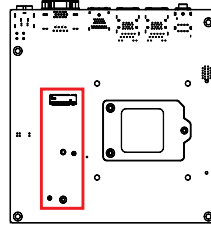

3

Carefully insert the M.2 SSD into the slot, and secure with screw.

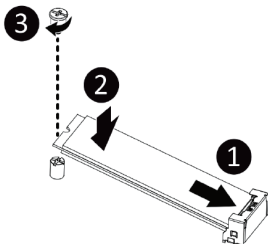

2.7 CPU Installation

1

Open CPU socket and assemble CPU into the socket.

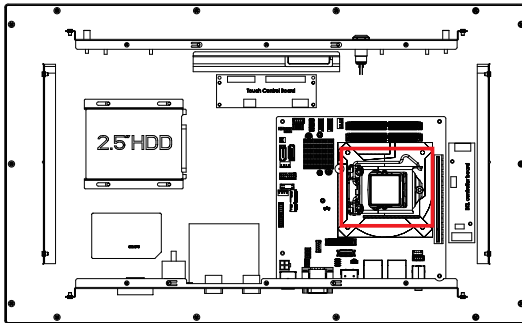

2

The notch of the CPU fansink needs to face DDR Slot, and put CPU fansink on the CPU.

Follow below assembly order to assemble CPU fansink.

Torsion : 4.5~5.0 kgf-cm

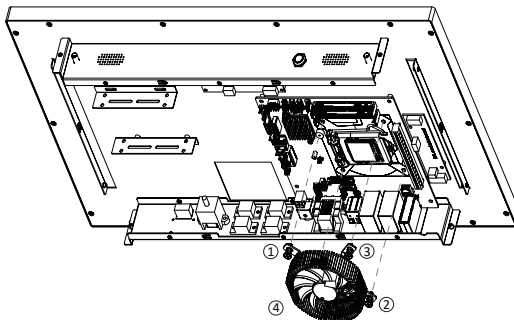

2.8 Antenna Installation (Antenna inclusion may vary based on local distribution)

1

Carefully insert the antennas into the connectors.

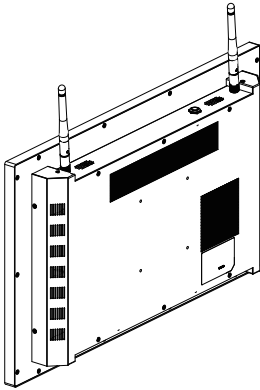

2

Turn the antennas clockwise until they are completely secure on the connectors.

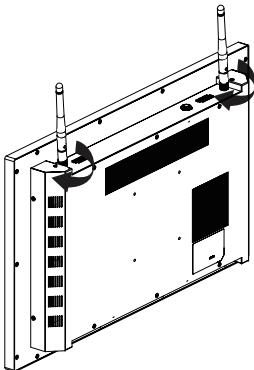

2.9 Cable Pin-define

1. DB9 COM (25CF8-180620-S9R / 25CF8-210620-S9R)

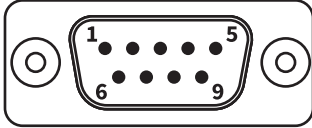

DB9 Pin	RS-232	RS-422 Full Duplex	RS-485 Half Duplex
1	DCD	TXD-	D-
2	RXD	TXD+	D+
3	TXD	RXD+	-
4	DTR	RXD-	-
5	GND		
6	DSR	-	-
7	RTS	-	-
8	CTS	-	-
9	RI	-	-

2. DBP DIO (25CR5-220601-S9R)

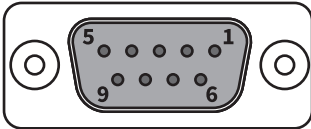

DBP DIO Pin	Pin Name
1	GPIO-output_1
2	GPIO-input_1
3	GPIO-output_2
4	GPIO-input_2
5	GPIO-output_3
6	GPIO-input_3
7	GPIO-output_4
8	GPIO-input_4
9	5V

2.10 Support

- For a list of tested memory, M.2, 2.5'' SSD, wireless adapters and OS supported, go to: <http://www.gigaipc.com>
- To download the latest drivers and BIOS updates, go to: <http://www.gigaipc.com>
- For product support, go to: <http://www.gigaipc.com>

2.11 Safety and Regulatory Information

Risk of explosion if the battery is replaced with an incorrect type. Batteries should be recycled where possible.

Disposal of used Batteries must be in accordance with local environmental regulations.

Failure to use the included Power Adapter may violate regulatory compliance and may expose the user to safety hazards.

HDMI™
HIGH DEFINITION MULTIMEDIA INTERFACE



At the end of its serviceable life, this product should not be treated as household or general waste. It should be handed over to the applicable collection point for the recycling of electrical and electronic equipment, or returned to the supplier for disposal.

Chapter 3

Chapter 3 – Hardware Information

3.1 Jumpers and Connectors

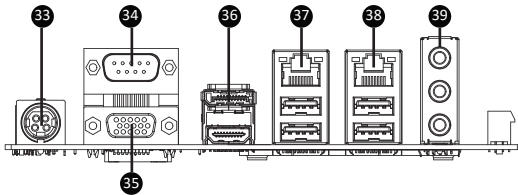
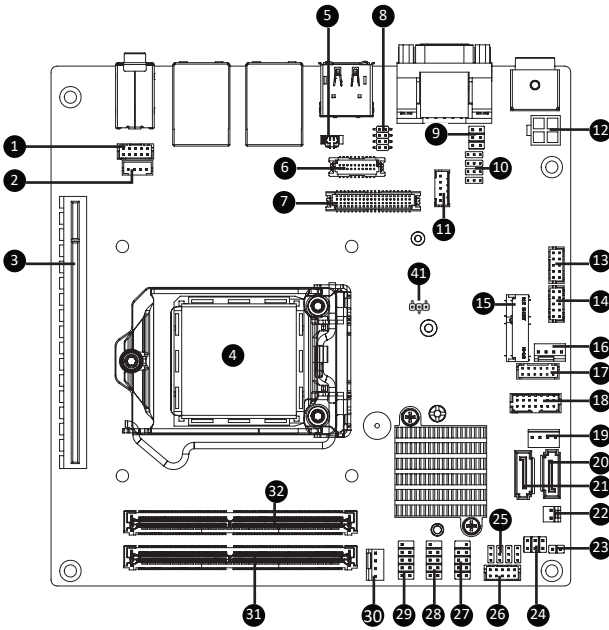

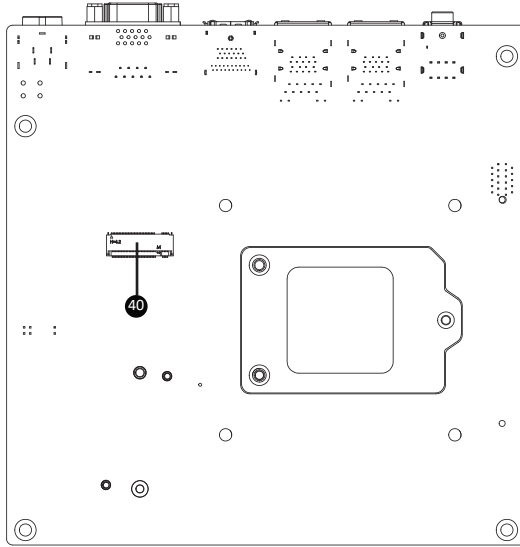

No	Code	Description
1	FP_AUDIO	Front audio header
2	SPKR	Speaker out connector
3	PCIEX16	PCIEX16 slot
4	LGA1151	Intel® LGA1151 socket
5	BATTERY	Battery cable connector
6	EDP	Embedded Display Port connector
7	LVDS	LVDS connector
8	LSW	LVDS resolution jumper
9	JCOM11	RI pin RI/5V/12V select jumper for COM1 port
10	JRS11-14	RS-232/422/485 select jumper for COM1 port
11	BKL_CN	Backlight Control connector

No	Code	Description
12	DC_IN2	ATX 2x2 pin power connector
13	COM4	Serial port header (RS-232)
14	COM3	Serial port header (RS-232)
15	M2E	1 x M.2 2230 E-Key slot
16	SYS_FAN	System fan connector
17	GPIO_CNT	General Purpose input/output header
18	TPM	TPM connector
19	SATA_PWR1	SATA power connector
20	SATA1	SATA 6Gb/s connector
21	SATA2	SATA 6Gb/s connector
22	ATX_CTL	ATX Control header
23	JCOM16	RI pin RI/5V/12V select jumper for COM2 port
24	CLR_CMOS	Clear CMOS jumper
25	JRS21-24	RS-232/422/485 select jumper for COM2 port
26	COM2	Serial port header (RS-232/422/485 & RI/5V/12V)
27	SYS_PANEL	Front panel header
28	FUSB2_1	USB 2.0 header
29	FUSB2_2	USB 2.0 header
30	CPU_FAN	CPU fan connector
31	SODIMM1	DDR4 SO-DIMM slot#1
32	SODIMM2	DDR4 SO-DIMM slot#2
33	DC_IN1	DC In Jack

No	Code	Description
34	COM1 (TOP)	Serial port (RS-232/422/485 & RI/5V/12V)
35	VGA (Bottom)	D-Sub port
36	HDMI_DP	Display port (top) HDMI port (bottom)
37	USB3_LAN1	2 x USB 3.2 Gen 1 + GbE LAN Port
38	USB3_LAN2	2 x USB 3.2 Gen 1 + GbE LAN Port
39	AUDIO	3 x Audio Jacks (Line in, Line out, Mic in)
40	M2_M	1 x M.2 Slot 2242/2280 Storage SATA
41	AT_CN	AT/ATX power mode select jumper

3.2.1 FP_AUDIO (Front audio header)

1

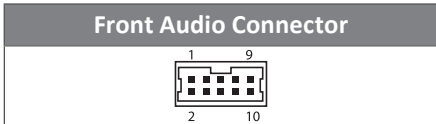
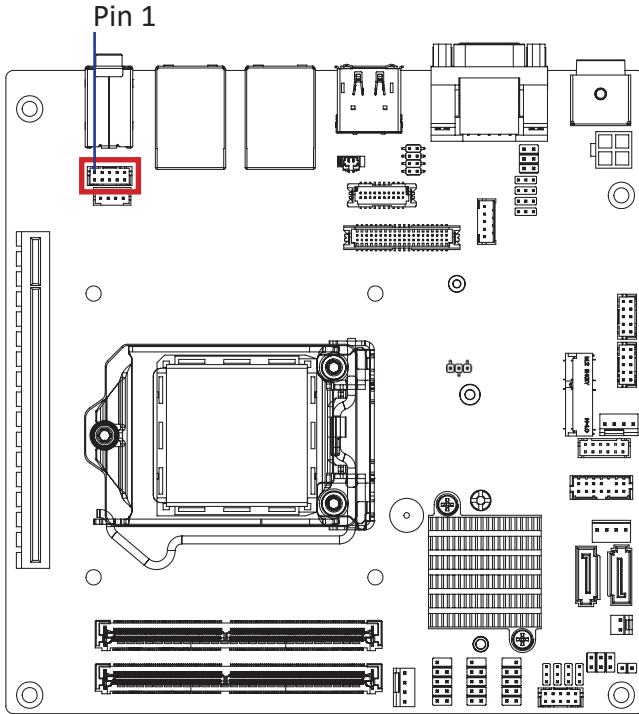

Connector PN	Vendor
725-81-10TW00	PINREX
A2004WV-2X05P46	JOINT-TECH

Pin No.	Definition	Pin No.	Definition
1	MIC_L	6	GND
2	GND	7	JD
3	MIC_R	8	No Connect
4	Detect	9	HPOUT_L
5	HPOUT_R	10	GND

3.2.2 SPKR (Speaker out Connector)

2

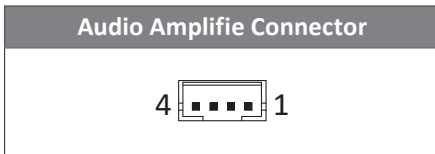
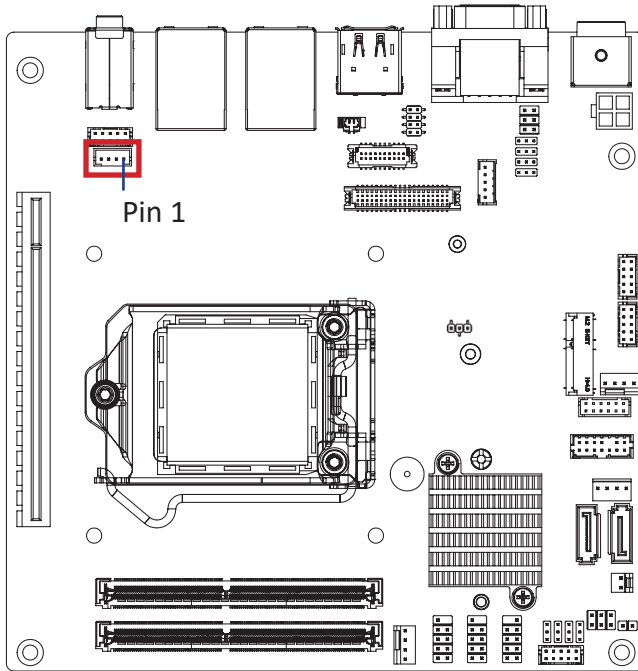

Connector PN	Vendor
721-81-045W00	PINREX
A2001WV-04P146	JOINT-TECH

Pin No.	Definition
1	Speaker Out L+
2	Speaker Out L-
3	Speaker Out R-
4	Speaker Out R+

3.2.3 BATTERY (Battery cable connector)

5

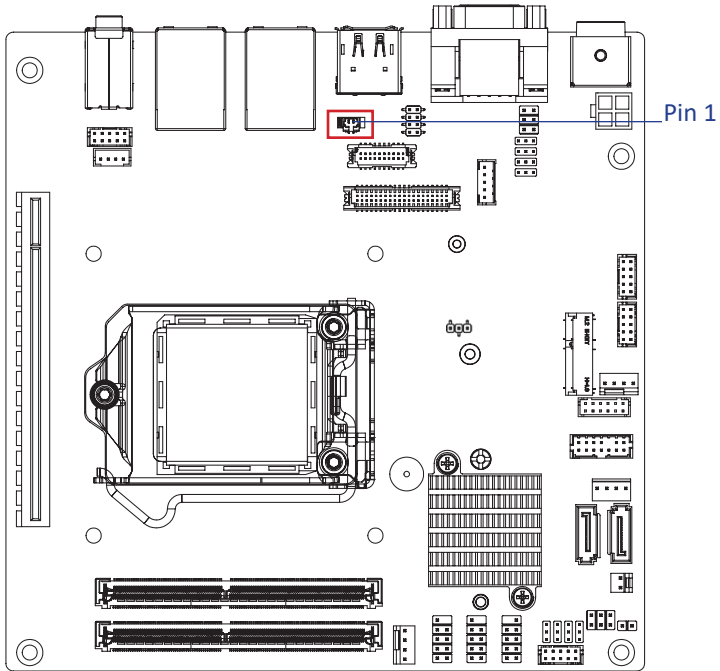

Battery Cable Connector	

Connector PN	Vendor
85205-0270L	ACES
A1250WV-S-02PC	JOINT-TECH

Pin No.	Definition
1	3.3V
2	GND

3.2.4 EDP (Embedded Display Port Connector)

6

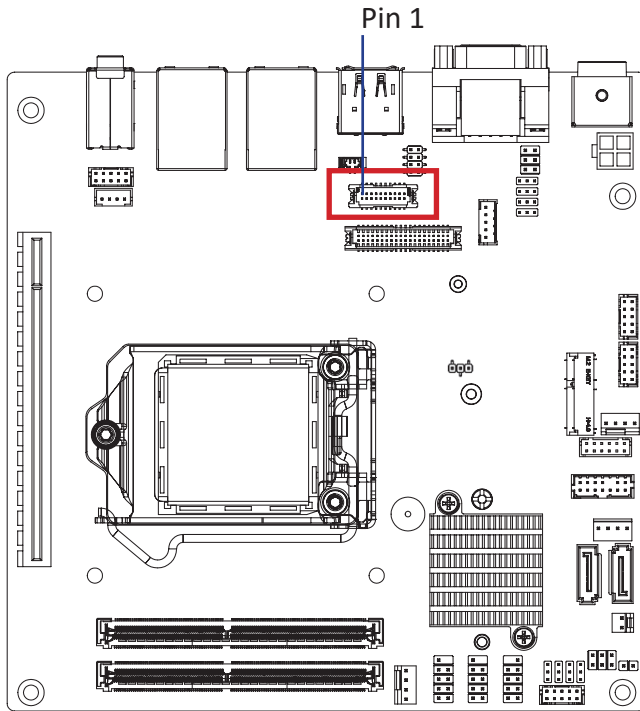

Embedded Display Port connector

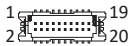

Pin No.	Definition	Pin No.	Definition
1	GND	11	eDP_1+
2	GND	12	eDPAUX-
3	eDP_0-	13	GND
4	eDP_3-	14	eDPAUX+
5	eDP_0+	15	eDP_2-
6	eDP_3+	16	GND
7	GND	17	eDP_2+
8	eDPSW *	18	HDP
9	eDP_1-	19	5V
10	GND	20	3.3V

Note: * Please ensure pin 8 is connected to Ground.

Connector PN	Vendor
A1252WV-SF-2X10PN6BG1G00L	JOINT-TECH
50286-02071-001	ACES

3.2.5 LVDS (LVDS connector)

7

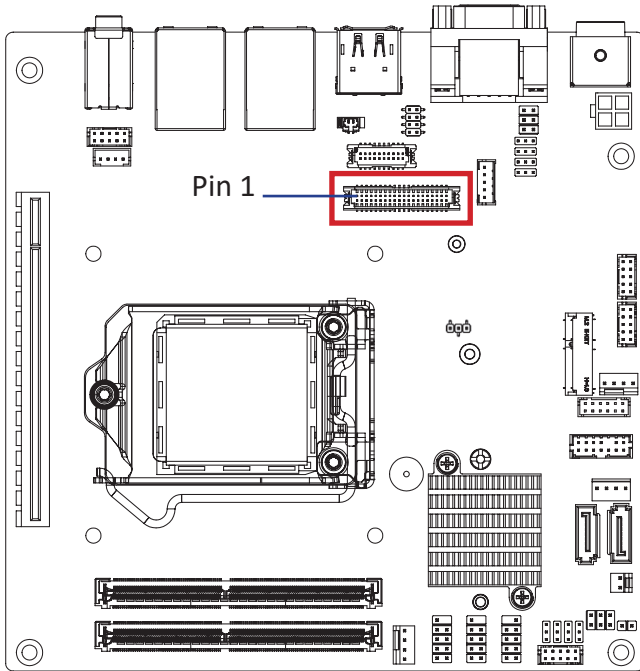

LVDS Connector

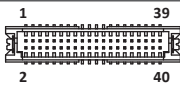

Pin No.	Definition	Pin No.	Definition
1	3.3V	21	A5+
2	5V	22	A4+
3	3.3V	23	A5-
4	5V	24	A4-
5	SPECO	25	GND
6	SPEDO	26	GND
7	GND	27	A7+
8	GND	28	A6+
9	A1+	29	A7-
10	A0+	30	A6-
11	A1-	31	GND
12	A0-	32	GND
13	GND	33	CLK2+
14	GND	34	CLK1+
15	A3+	35	CLK2-

Pin No.	Definition	Pin No.	Definition
16	A2+	36	CLK1-
17	A3-	37	GND
18	A2-	38	GND
19	GND	39	12V
20	GND	40	12V

Connector PN	Vendor
712-76-40GWE0	PINREX
A1252WV-SF-2X20PD01	JOINT-TECH









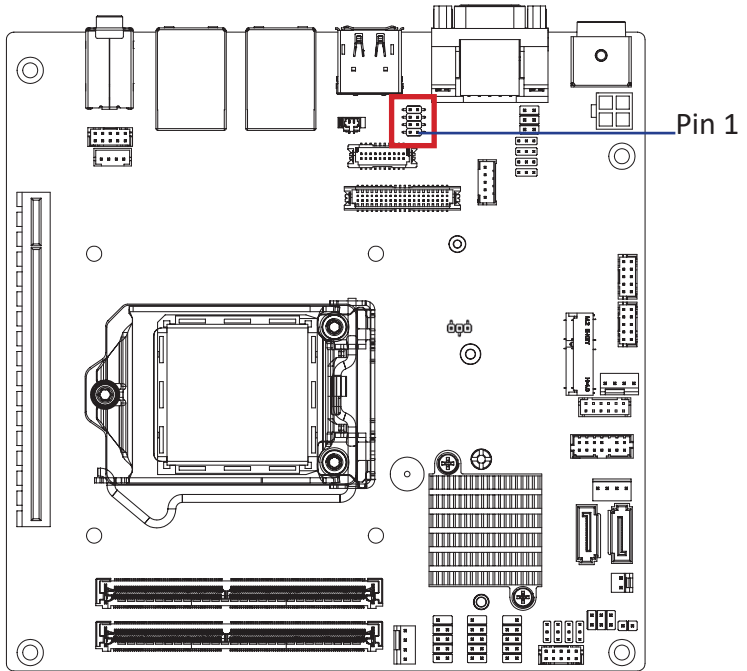







For each model support LVDS function.
 But below model no need to add.
 A0~A3 is odd channel 0~3, A4~A7 is even channel.

Note: *The LVDS output connector of the unit is only intended to be connected to an UL/IEC/EN approval equipment with fire enclosure.

3.2.6 LSW (LVDS resolution jumper)

8



LVDS Resolution Jumper			
Jumper Setting	Resolution	Jumper Setting	Resolution
	800 x 600 18bit		1366 x 768 24bit
	1024 x 768 18bit		1440 x 900 24bit
	1024 x 768 24bit		1400 x 1050 24bit
	1024 x 600 18bit		1600 x 900 24bit
	1280 x 800 18bit		1680 x 1050 24bit
	1280 x 960 18bit		1600 x 1200 24bit
	1280 x 1024 24bit		1920 x 1080 24bit
	1366 x 768 18bit		1920 x 1200 24bit

Connector PN	Vendor
222-97-04GBE1	PINREX

3.2.7 JCOM11 (RI pin RI/5V/12V Select jumper for COM1 port)

9

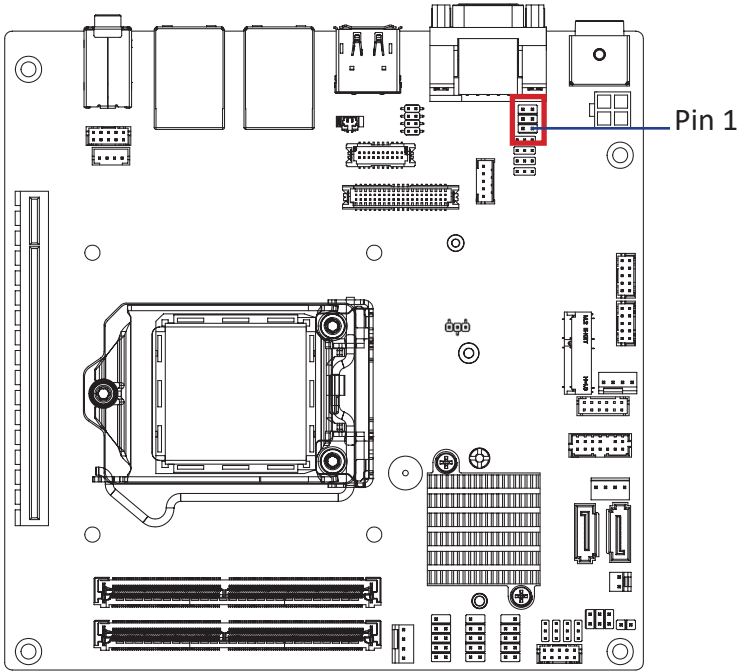

JCOM11 Jumper	
<p>6 5 □ □ □ □ ■ ■ 2 1</p>	<p>1-2 Close: 5V (Power COM)</p>
<p>6 5 □ □ ■ ■ □ □ 2 1</p>	<p>3-4 Close: RI (Stand COM)(Default)</p>
<p>6 5 □ □ □ □ ■ ■ 2 1</p>	<p>5-6 Close: 12V (Power COM)</p>

Connector PN	Vendor
220-97-03GB01	PINREX
PH06N53BAZ000	HORNGTONG

3.2.8 JRS11-14 (RS-232/422/485 select jumper for COM1 port)

10

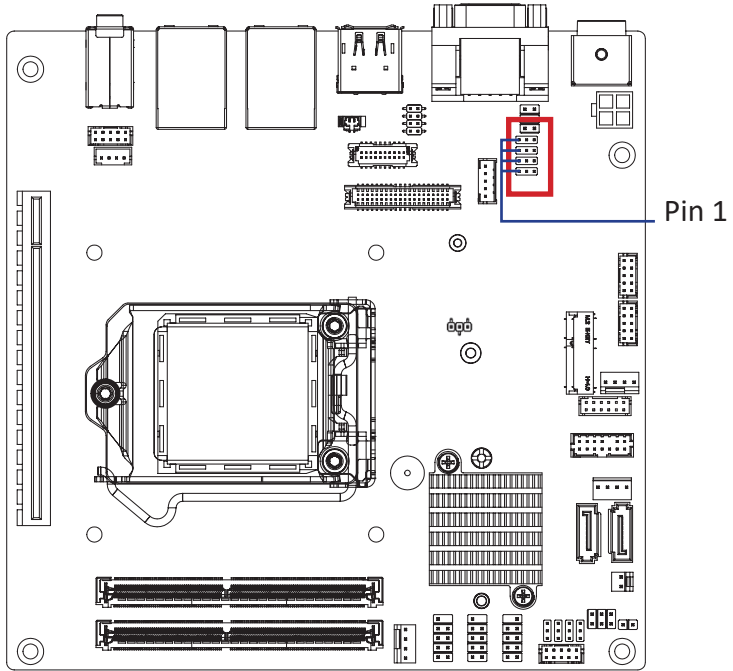

JRS11-14 Jumper
123
RS-232 (Default-setting)

Connector PN	Vendor
220-96-03GB01	PINREX
PH03N2-7BAN000	HORNGTONG

Mode	RS-422 Full Duplex	Pure RS-232	RS-485 Half Duplex	RS-485 Half Duplex	RS-422 Full Duplex	RS-485 Half Duplex
Status	1T/1R RS-422	3T/5R RS-232 (Default)	1T/1R RS-485, TX ENABLE Low Active	1T/1R RS-485, TX ENABLE High Active	1T/1R RS-422 with termination resistor and bias resistor.	1T/1R RS-485 with termination resistor and bias resistor. TX ENABLE Low Active
Jumper Setting	1 3 	1 3 	1 3 	1 3 	1 3 	1 3

3.2.9 BKL_CN (Backlight Control connector)

11

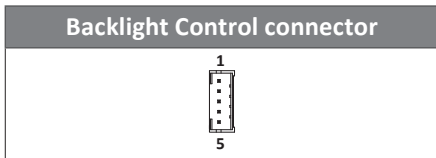
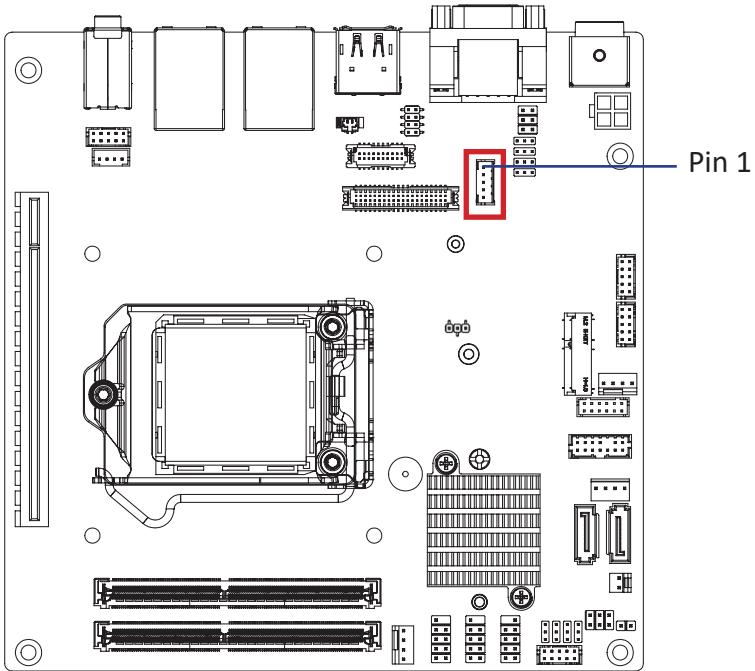

Connector PN	Vendor
85205-0270L	ACES
A1250WV-S-02PC	JOINT-TECH

Pin No.	Definition
1	5V
2	PWM
3	Back Light Enable
4	GND
5	12V

3.2.10 DC_IN2 (ATX 2x2 pin power connector)

12

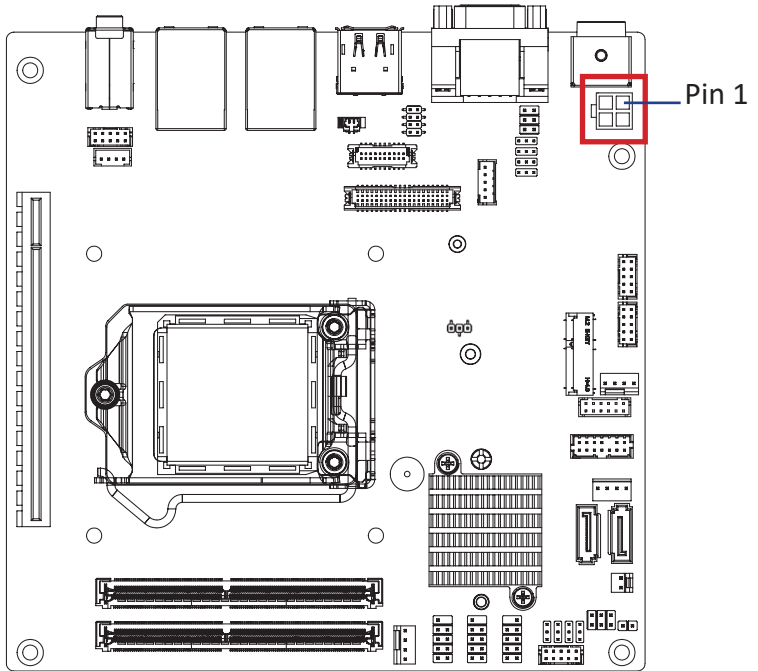

Power Connector

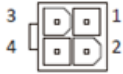

Connector PN

740-81-04TW56

25104A0400B3-93LF

Vendor

PINREX

ATRC

Pin No.	Definition
1	GND
2	GND
3	+12V
4	+12V

3.2.11 COM4 (Serial Port header (RS-232))

13

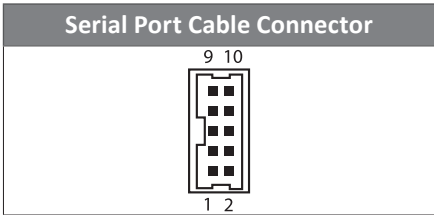
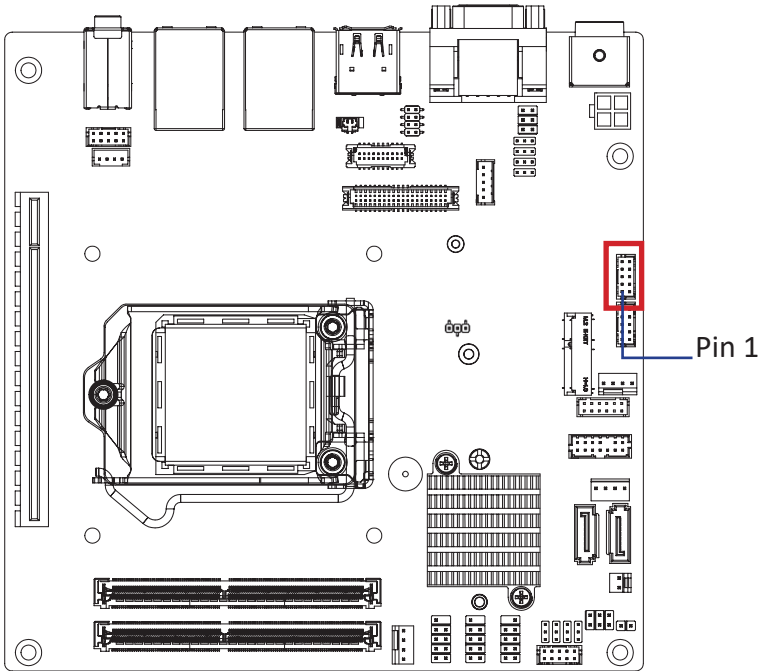

Connector PN	Vendor
725-81-10TW00	PINREX
A2004WV-2X05P46	JOINT-TECH

Pin No.	Definition	Pin No.	Definition
1	RXD	6	GND
2	DCD	7	CTS
3	DTR	8	RTS
4	TXD	9	No Connect
5	DSR	10	RI/ 5V/ 12V

3.2.12 COM3 (Serial Port header (RS-232))

14

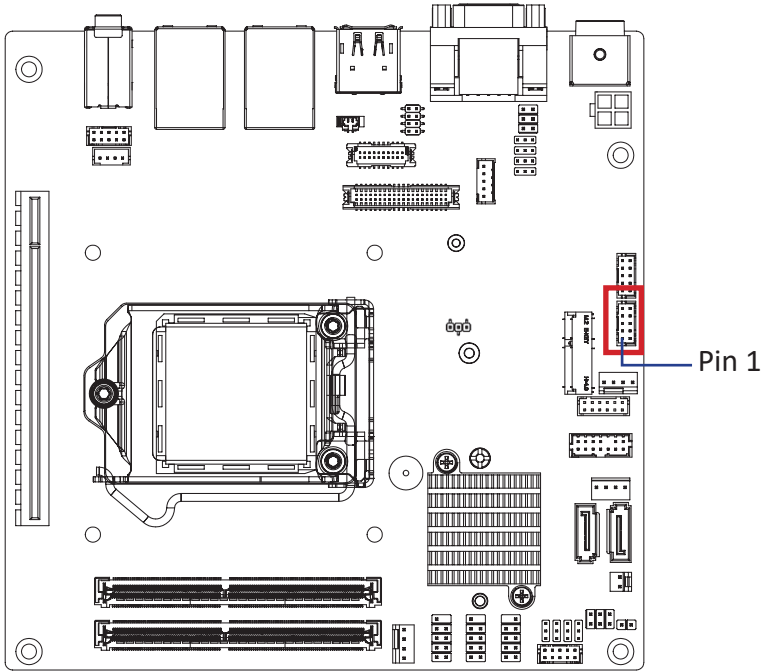

Serial Port Cable Connector



Connector PN

725-81-10TW00
A2004WV-2X05P46

Vendor

PINREX
JOINT-TECH

Pin No.	Definition	Pin No.	Definition
1	RXD	6	GND
2	DCD	7	CTS
3	DTR	8	RTS
4	TXD	9	No Connect
5	DSR	10	RI/ 5V/ 12V

3.2.13 SYS_FAN (System Fan Connector)

16

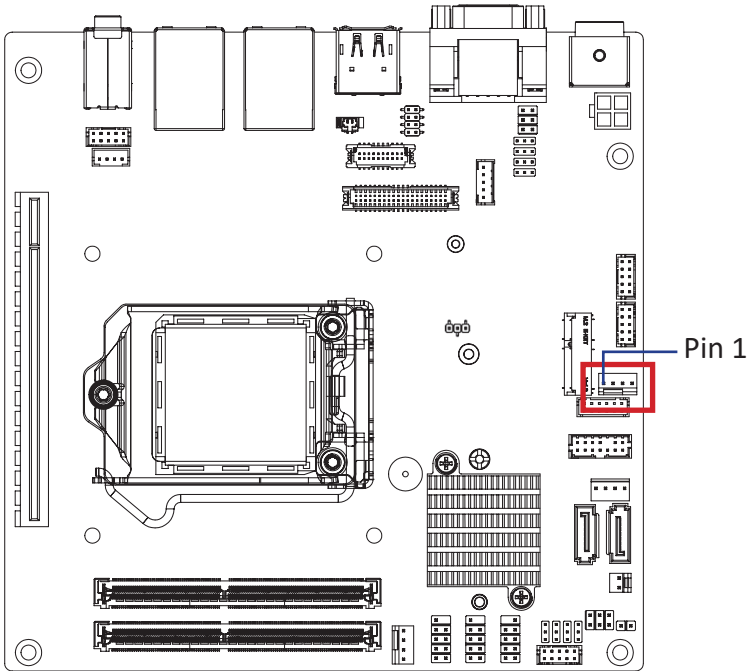

System FAN	
1	4

Connector PN	Vendor
744-81-045R11	PINREX
WF04R22RJQ105	HORNGTONG

Pin No.	Definition
1	GND
2	12V
3	Detect
4	Speed Control

3.2.14 GPIO_CNT (General Purpose input/output header)

17

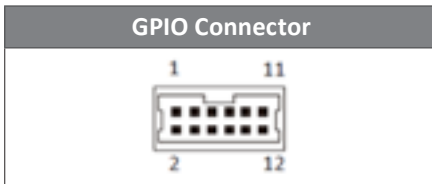
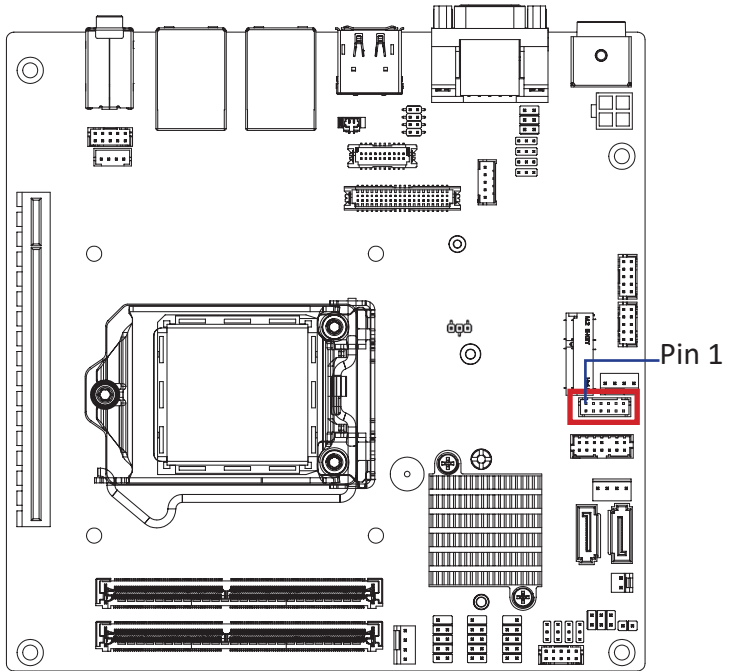

Pin No.	Definition
9	SMBus Clock
10	SMBus DATA
11	5V
12	GND

Pin No.	Definition
1	GPIO-output_1
2	GPIO-input_1
3	GPIO-output_2
4	GPIO-input_2
5	GPIO-output_3
6	GPIO-input_3
7	GPIO-output_4
8	GPIO-input_4

Connector PN	Vendor
725-81-12TW00	PINREX
A2004WV-2X06P46	JOINT-TECH

3.2.15 TPM (Trusted Platform Module Connector)

18

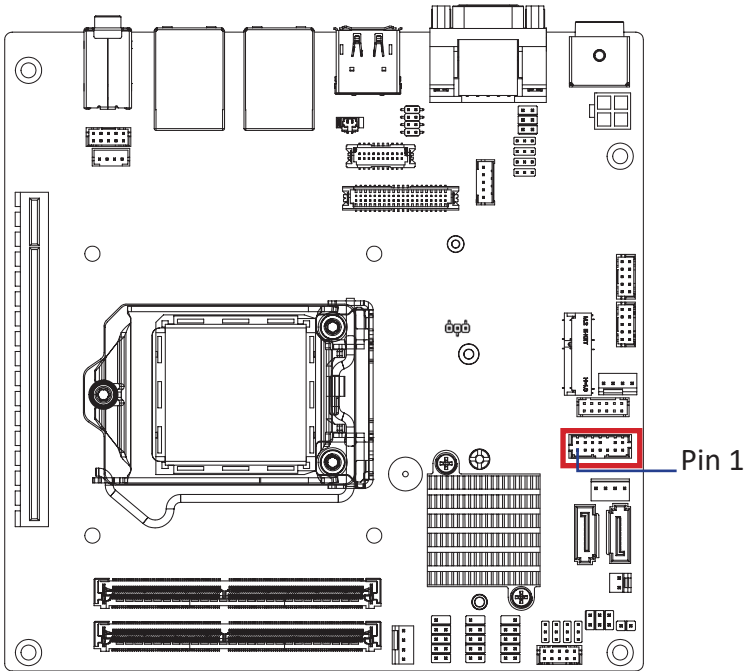

TPM Module Connector	
2	14
1	13

Pin No.	Definition
1	Clock
2	3.3V
3	PFM Reset
4	3.3V
5	LAD0
6	IRQ_SERIAL
7	LAD1

Pin No.	Definition
8	Detect
9	LAD2
10	NC
11	LAD3
12	GND
13	LFRAME
14	GND

Connector PN	Vendor
52M-90-14GBE7	PINREX

3.2.16 SATA_PWR1 (SATA Power Connector)

19

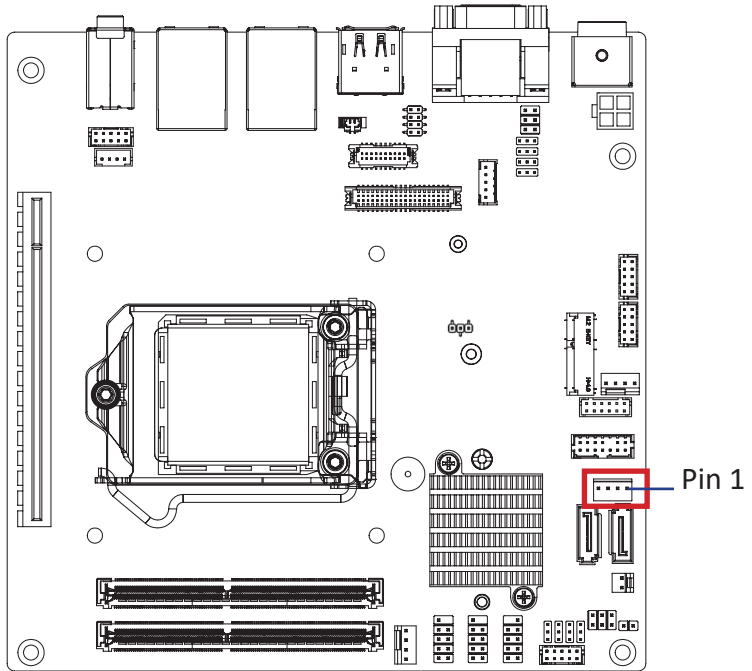

Hard Disk Power Connector

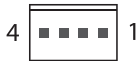

Connector PN

743-81-04TW00
WF04Q2-3BJQ000

Vendor

PINREX
HORNGTONG

Pin No.

Definition

1	12V
2	GND
3	GND
4	5V

3.2.17 SATA1, SATA2 (SATA 6Gb/s Connector)

2021

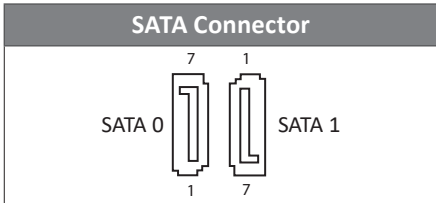
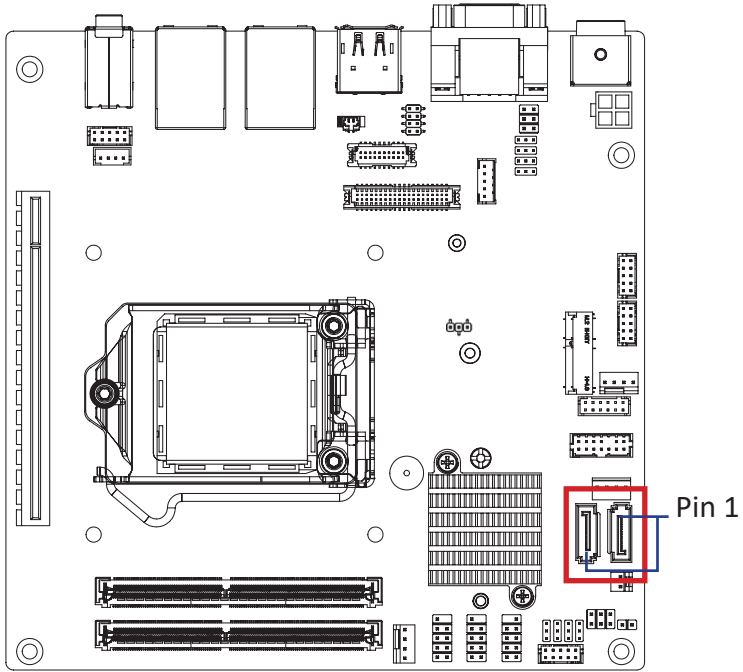

SATAIII_1, SATAIII_0	
Connector PN	Vendor
WATM-07ABNB2BAUW3	WINWIN
770-83-07SW19	PINREX

Pin No.	Definition	Pin No.	Definition
1	GND	2	A+
3	A-	4	GND
5	B-	6	B+
7	GND		

3.2.18 ATX_CTL (ATX Control header)

22

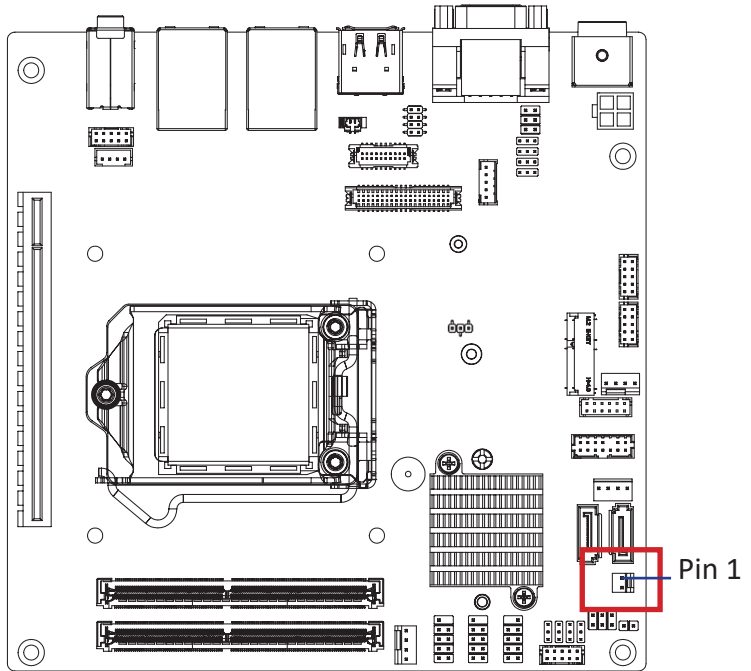

ATX Control header



Pin No.	Definition
1	ATX_PSON
2	ATX_5VSB

3.2.19 JCOM16 (RI pin RI/5V/12V select jumper for COM2 port)

23

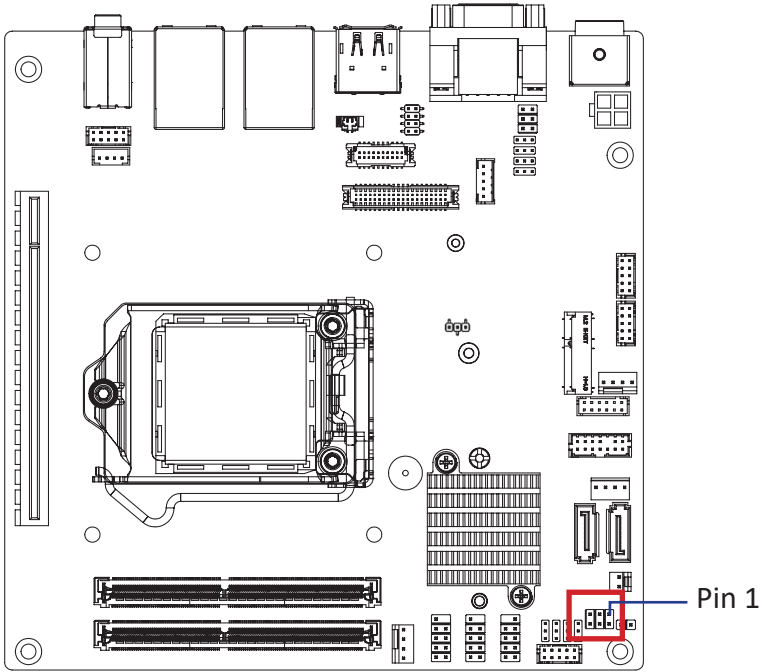

JCOM16 Jumper	
	1-2 Close: 5V (Power COM)
	3-4 Close: RI (Stand COM)(Default)
	5-6 Close: 12V (Power COM)

Connector PN	Vendor
220-97-03GB01	PINREX
PH06N53BAZ000	HORNGTONG

3.2.20 CLR_CMOS (Clear CMOS Jumper)

24

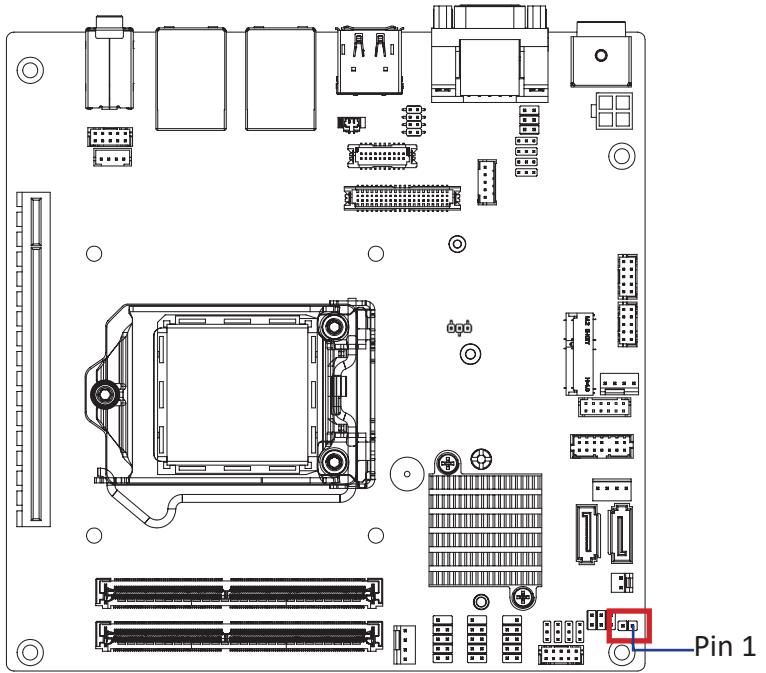

Clear COMS Jumper	
2	1

Connector PN	Vendor
210-91-02GB01	PINREX
PH02R23BAZ000	HORNGTONG

Pin No.	Definition
1	Clear CMOS
2	GND
Open: Normal Operation (Default setting) Close: Clear COMS data.	

3.2.21 JRS21-24 (RS-232/422/485 select jumper for COM2 port)

25

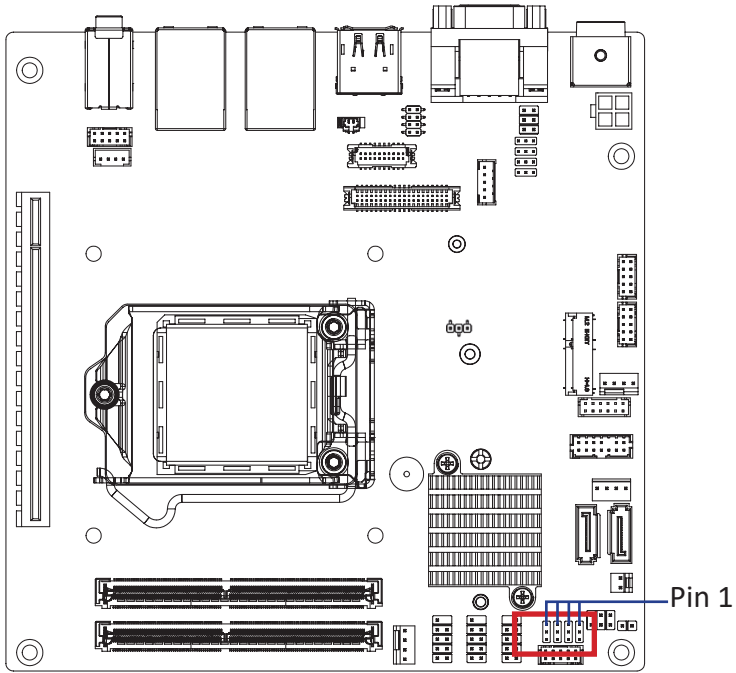

JRS21-24 Jumper
RS-232 (Default-setting)

Connector PN	Vendor
220-96-03GB01	PINREX
PH03N2-7BAN000	HORNGTONG

Mode	RS-422 Full Duplex	Pure RS-232	RS-485 Half Duplex	RS-485 Half Duplex	RS-422 Full Duplex	RS-485 Half Duplex
Status	1T/1R RS-422	3T/5R RS-232 (Default)	1T/1R RS-485, TX ENABLE Low Active	1T/1R RS-485, TX ENABLE High Active	1T/1R RS-422 with termination resistor and bias resistor.	1T/1R RS-485 with termination resistor and bias resistor. TX ENABLE Low Active
Jumper Setting						

3.2.22 COM2 (Serial Port header (RS-232/422/485 & RI/5V/12V))

26

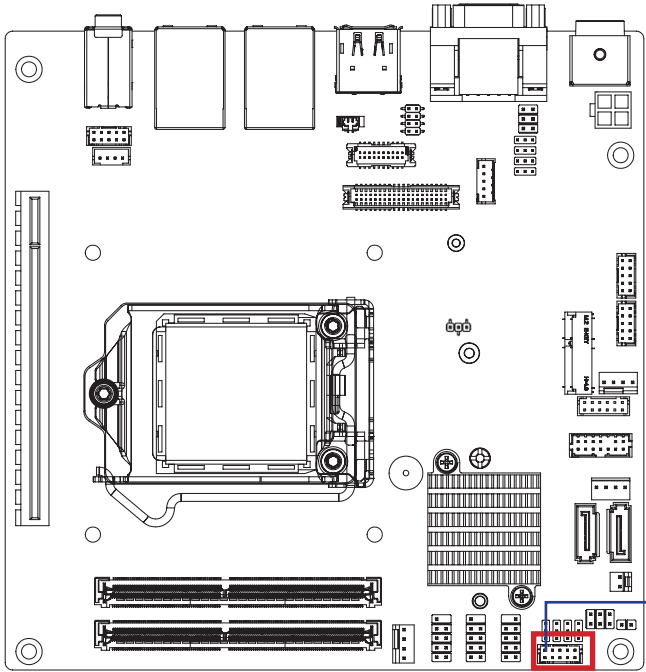

Pin 1

Serial Port Cable Connector



Connector PN

725-81-10TW00

A2004WV-2X05P46

Vendor

PINREX

JOINT-TECH

Pin No.	RS-232	RS-422 Full Duplex	RS-485 Half Duplex
1	RXD	TXD+	D+
2	DCD	TXD-	D-
3	DTR	RXD-	-
4	TXD	RXD+	-
5	DSR	-	-
6	GND	-	-
7	CTS	-	-
8	RTS	-	-
9	No Connect	-	-
10	RI/5V/12V	-	-

3.2.23 SYS_PANEL (Front Panel header)

27

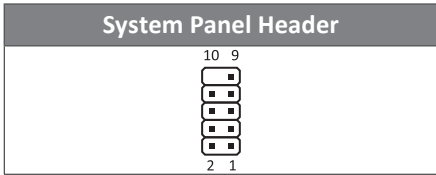
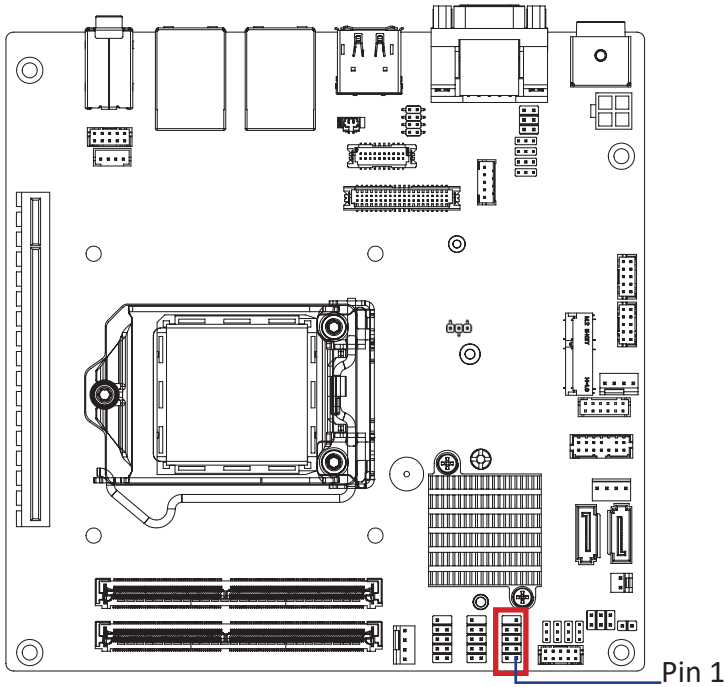

Connector PN	Vendor
210-92-05G111	PINREX

Pin No.	Definition
1	HDD LED+
2	Power LED+
3	HDD LED-
4	Power LED-
5	GND
6	Power Button+
7	Reset Button
8	Power Button-
9	No Connect
10	No Pin

3.2.24 FUSB2_1 (USB 2.0 header)

28

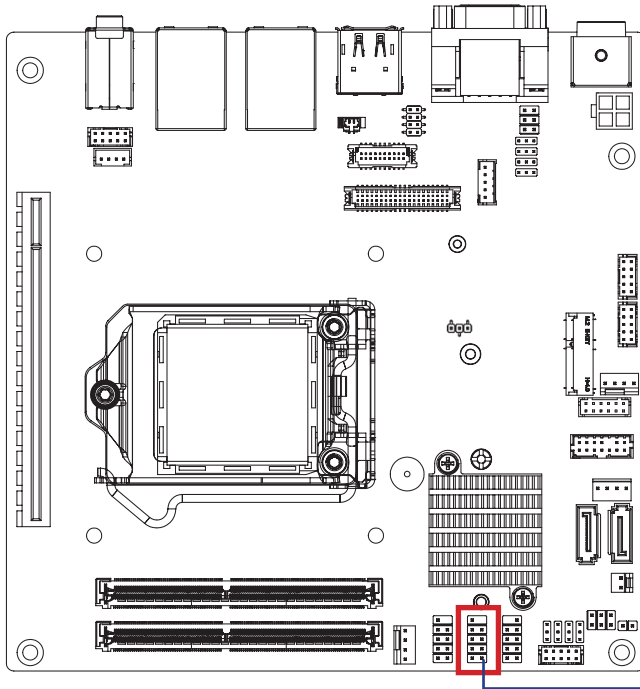

Pin 1

USB 2.0 Header



Connector PN

210-92-05GB04

Vendor

PINREX

PH10R53BAZ009

HORNGTONG

Pin No.	Definition
1	5V
2	5V
3	DX-
4	DY-
5	DX+
6	DY+
7	GND
8	GND
9	No Pin
10	No Connect

3.2.25 FUSB2_2 (USB 2.0 header)

29

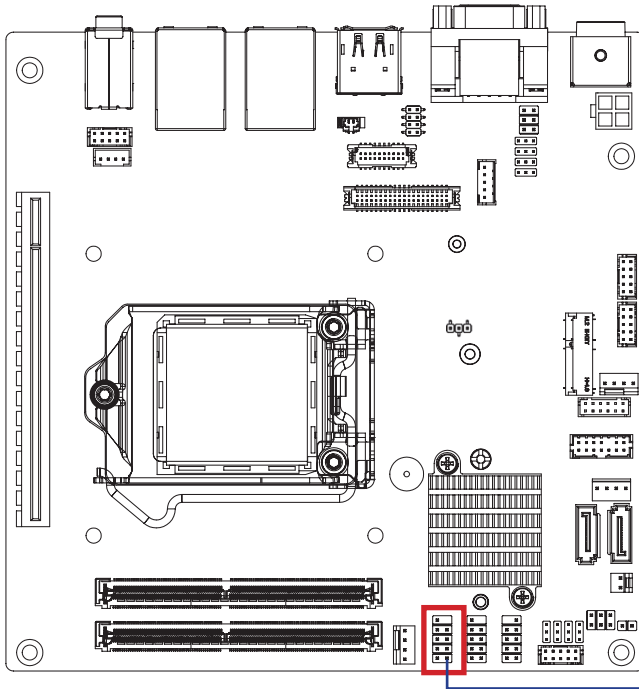

Pin 1

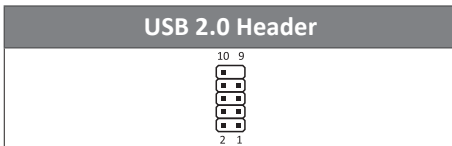

Connector PN	Vendor
210-92-05GB04	PINREX
PH10R53BAZ009	HORNGTONG

Pin No.	Definition
1	5V
2	5V
3	DX-
4	DY-
5	DX+
6	DY+
7	GND
8	GND
9	No Pin
10	No Connect

3.2.26 CPU_FAN (CPU fan connector)

30

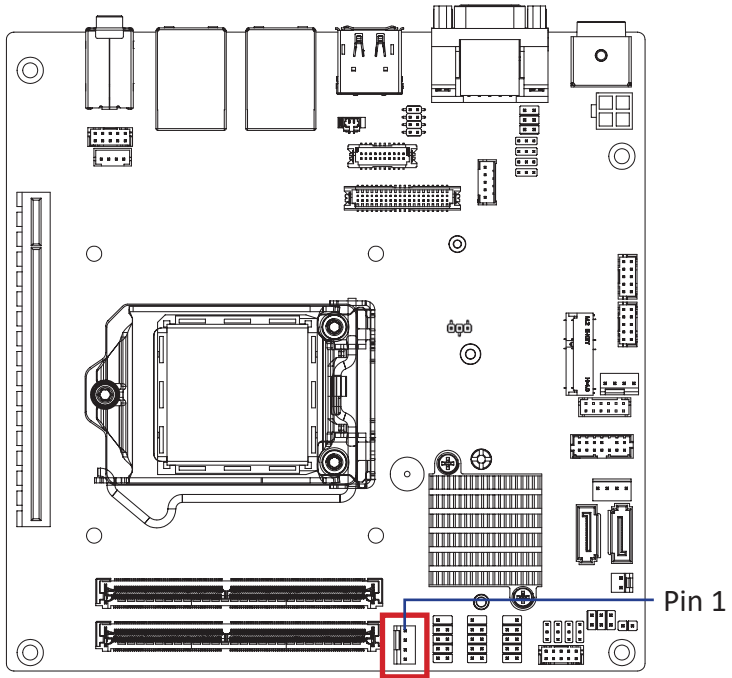

CPU FAN Connector



Connector PN	Vendor
744-81-045W11	PINREX
WF04R22WJQ195	HORNGTONG

Pin No.	Definition
1	GND
2	12V
3	Detect
4	Speed Control

3.2.27 DC_IN1 (DC In JACK Connector)

33

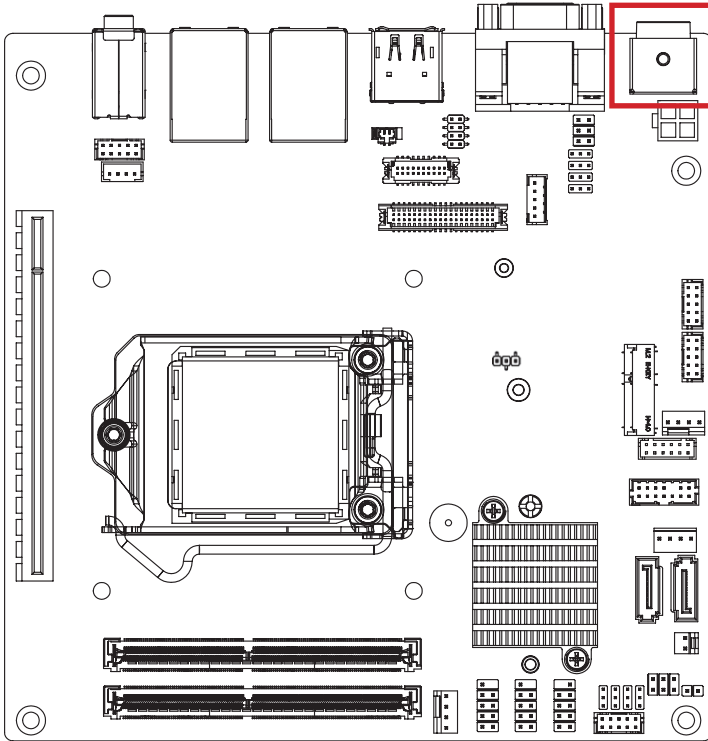

DC JACK Connector



Connector PN

2MJ-3422A110

Vendor

SINGATRON

3.2.28 COM1 (Serial port (RS-232/422/485 & RI/5V/12V))

34

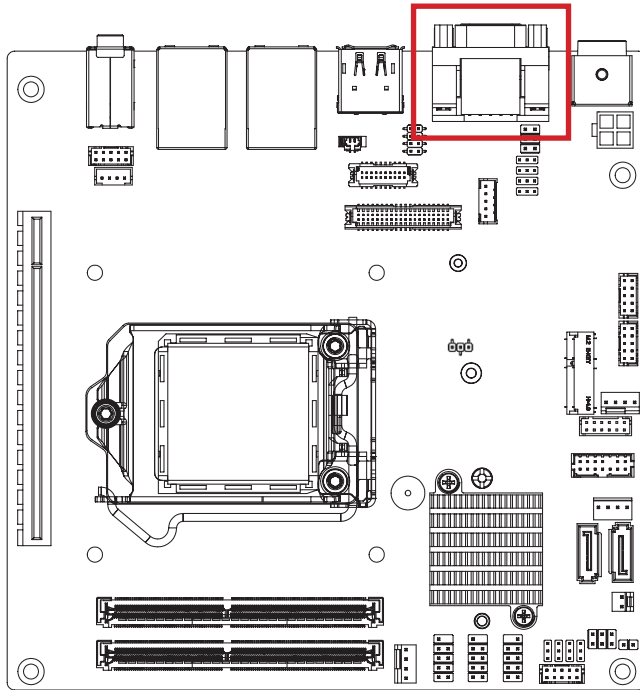

Serial Port Connector

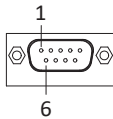

Connector PN

DM10151-N5W3-4F

Vendor



FOXCONN

Pin No.	RS-232	RS-422 Full Duplex	RS-485 Half Duplex
1	DCD	TXD-	D-
2	RXD	TXD+	D+
3	TXD	RXD+	-
4	DTR	RXD-	-
5	GND		
6	DSR	-	-
7	RTS	-	-
8	CTS	-	-
9	RI	-	-

3.2.29 AT_CN (AT/ATX mode select jumper)

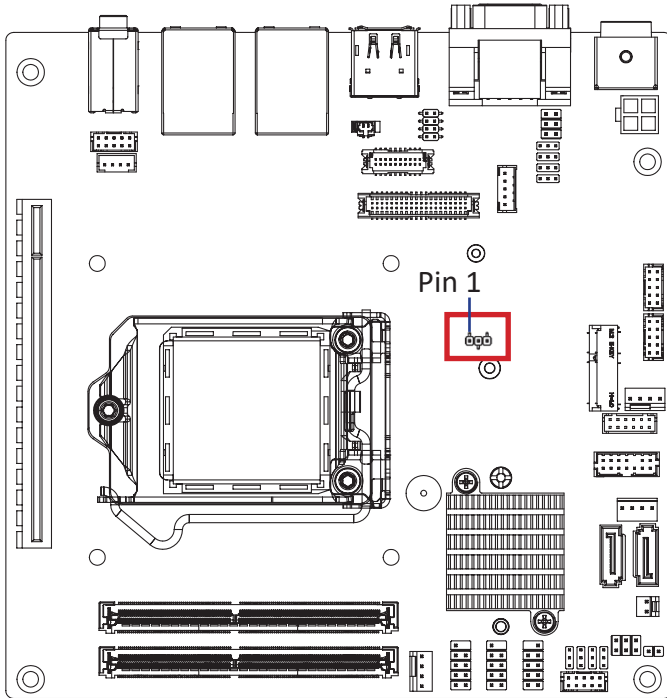
33



AT/ATX mode select jumper	
1	3
	

Connector PN	Vendor
222-96-03GBE1	PINREX

Pin No.	Definition
1	AT MODE
2	Detect
3	ATX MODE

Jumper setting
 1-2 Close : AT mode.
 2-3 Close : ATX mode. (Default setting)

Chapter 4

Chapter 4 – BIOS

4.1 Introduction

BIOS (Basic input/output system) provides hardware detailed information and boot-up options, which include firmware to control, set-up and test all hardware settings. Therefore, BIOS is the communication bridge between OS/application software and hardware.

4.1.1 How to Entering into BIOS menu

Once the system is power on, press the key as soon as possible to access into BIOS Setup program.

4.1.2 Function Keys to setup in BIOS Setup program

Function keys	Description
→←	Select Screen
↑↓	Select Item
Enter	Execute command or enter the submenu
+	Increase the numeric value or make changes
—	Decrease the numeric value or make changes
F1	General Help
F2	Previous Values
F3	Load Optimized Defaults Settings
F4	Save changes & Exit the BIOS Setup program
ESC	Exit the BIOS Setup program

4.2 The Main Menu

The main menu shows the basic system information. Use arrow keys to move among the items.

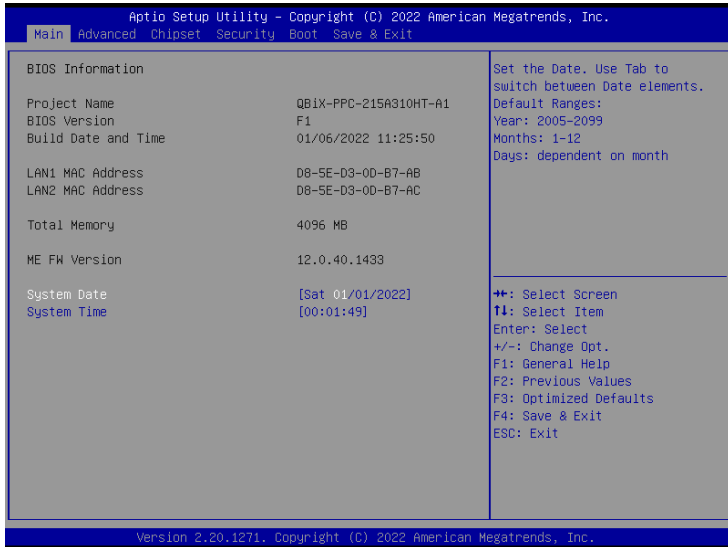

Items	Description
Project Name	Shows Project name information
BIOS Version	Shows the BIOS version of the system
Build Date and Time	Shows the Build Date and Time when the BIOS was created.
LAN1 MAC Address	Shows LAN1 MAC Address information
LAN2 MAC Address	Shows LAN2 MAC Address information
Total Memory	Shows the total memory size of the installed memory
ME FW version	Shows ME firmware version
System Date	Set the Date for the system (Format : Week - Month - Day - Year)
System Time	Set the time for the system (Format : Hour - Minute - Second)

4.3 Advanced

The Advanced menu is to configure the functions of hardware settings through submenu. Use arrow keys to move among the items, and press <Enter> to access into the related submenu.

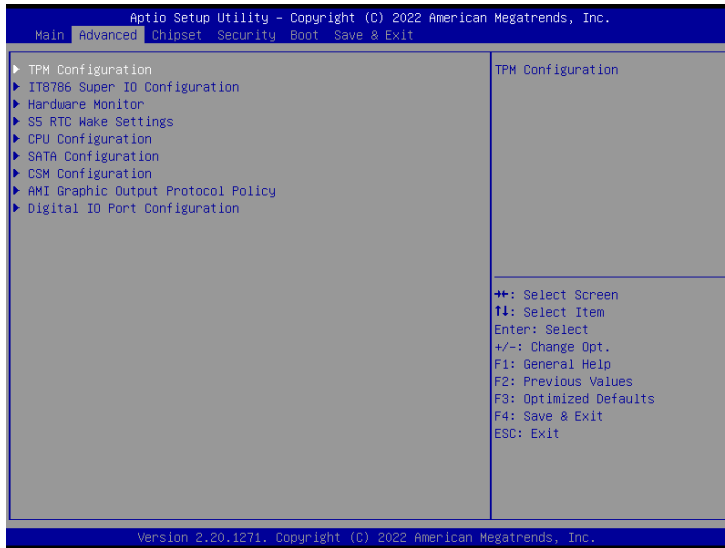

4.3.1 TPM Configuration

Use TPM Configuration submenu to choose TPM interface.

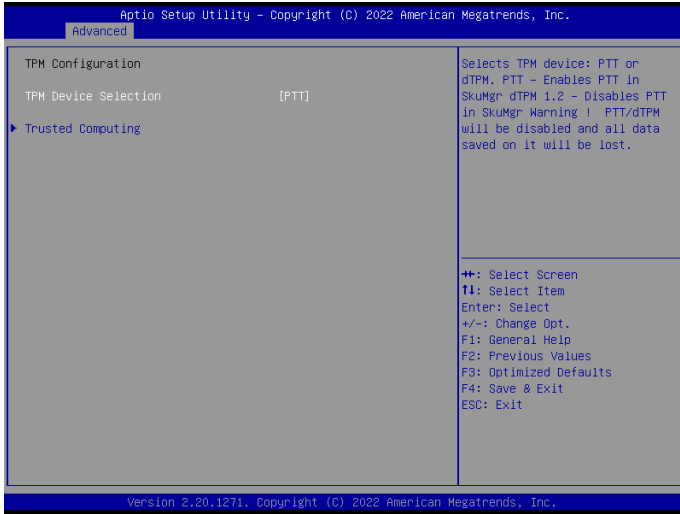

Item	Description
TPM Device Selection	PTT : Internal TPM (Default setting) dTPM : External TPM (When using External TPM module or having TPM chip on MB)

Trusted Computing : Shows TPM information, and TPM module configuration setting.



Item	Description
Security Device support	Enabled : Enables TPM feature (Default setting) Disabled : Disables TPM feature
Pending operation	None : No execution will be conducted (Default setting) TPM clear : Set to clear data on TPM
Physical Presence Spec Version	Choose PPI spec version Option items : 1.2 or 1.3 (Default setting)

4.3.2 IT8786 Super IO Configuration

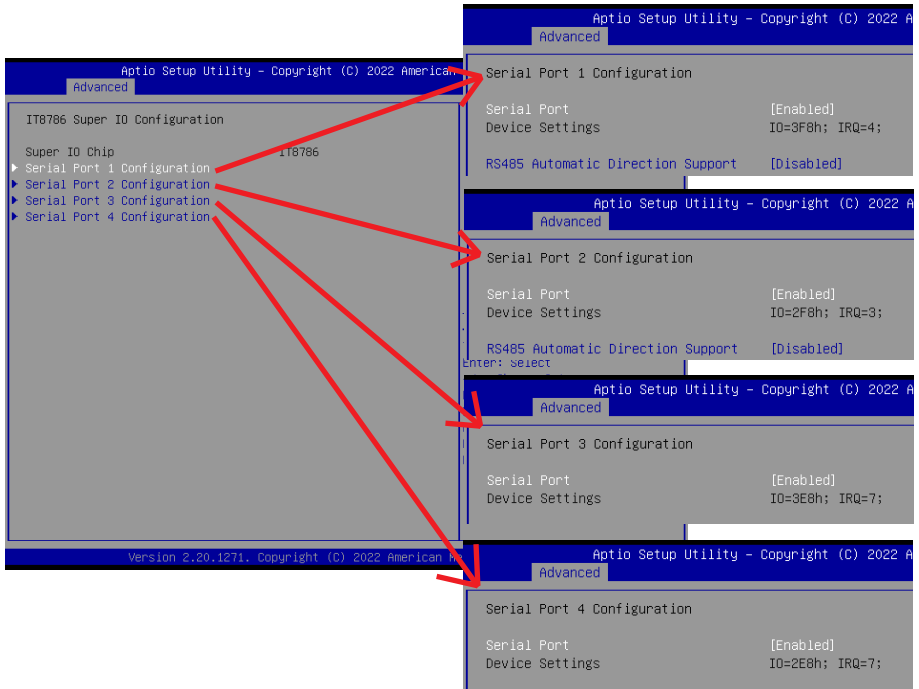

Item	Description
Serial Port 1 Configuration	Press [Enter] to configure advanced items : Serial Port : Enabled : Enables allows you to configure the serial port settings Disabled : if Disabled, displays no configuration for the serial port
Serial Port 2 Configuration	Device settings : Display the specified Serial Port base I/O address and IRQ RS485 Automatic Direction Support : Disabled : Disables for support RS485 automatic direction (Default setting) Enabled : Enables for support RS485 automatic direction
Serial Port 3 Configuration	Press [Enter] to configure advanced items : Serial Port : Enabled : Enables allows you to configure the serial port settings Disabled : if Disabled, displays no configuration for the serial port
Serial Port 4 Configuration	Device settings : Display the specified Serial Port base I/O address and IRQ

4.3.3 Hardware Monitor

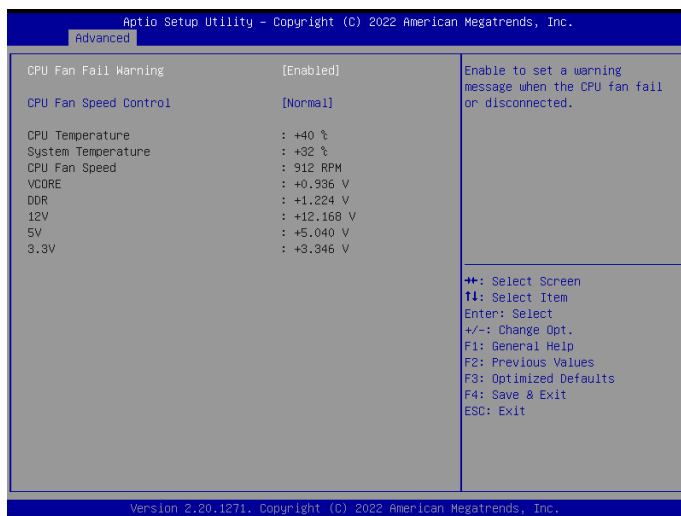

Item	Description
CPU Fan Fail Warning	Enabled : Enables CPU FAN Fail warning alert function (Default setting) Disabled : Disables CPU FAN Fail warning alert function
CPU Fan Speed Control	Normal : Fan speed set by BIOS default (Default setting) Full Speed : Set Fan operates at full speed
CPU Temperature	Shows current CPU temperature
System Temperature	Shows current system temperature
CPU Fan Speed	Shows current CPU fan Speed

4.3.4 S5 RTC Wake Settings

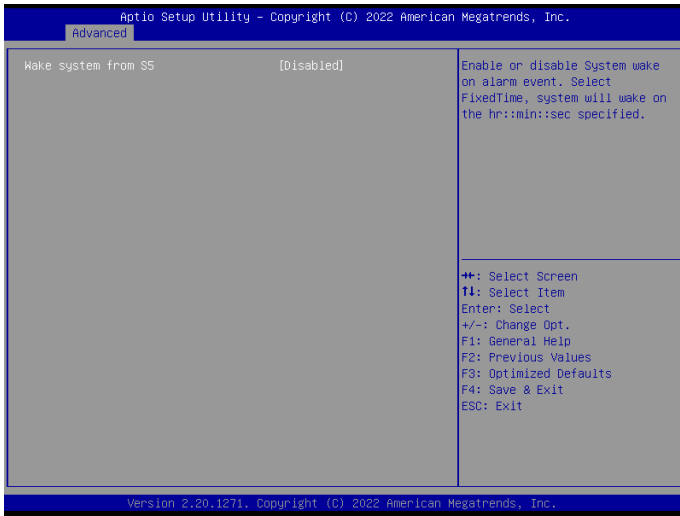

Item	Description
<p>Wake system from S5</p>	<p>Enable or Disable System to wake on a specific time. Disabled : Disables system to wake on a specific time (Default setting) Fixed Time : Enables system to wake on a specific time (Format : hr : min : sec)</p>

4.3.5 CPU Configuration

This submenu shows detailed CPU informations.

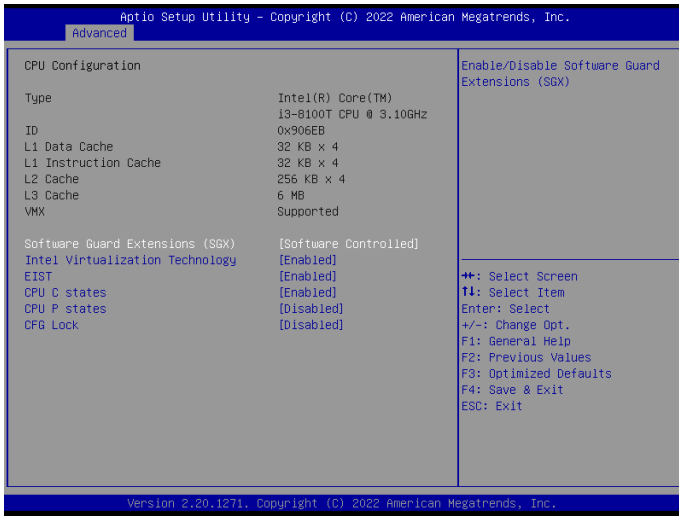

Item	Description
Software Guard Extensions (SGX)	Disabled : Disables Software Guard Extensions (SGX) Enabled : Enables Software Guard Extensions (SGX) Software Controlled : If this item is selected, SGX will be controlled by SGX application for UEFI boot OS (Default setting)
Intel Virtualization Technology	Virtualization enhanced by Intel® Virtualization Technology will allow a platform to run multiple operating systems and applications in independent partitions. With virtualization, one computer system can function as multiple virtual systems. Enabled : Enables Intel Virtualization Technology (Default setting) Disabled : Disables Intel Virtualization Technology
EIST	According to System loading, Enhanced Intel SpeedStep Technology (EIST) will automatically adjust the CPU voltage and core frequency to decrease heat and power consumption for power saving. Enabled : Enables EIST Technology (Default setting) Disabled : Disables EIST Technology
CPU C states	Command CPU to enter into low power consumption mode when CPU is under idle mode. Enabled : Enables C states (Default setting) Disabled : Disables C states
CPU P states	CPU will adjust frequency depends on it's loading. Enabled : Enables CPU P states function Disabled : Disables CPU P states function (Default setting)
CFG Lock	Enabled : Configure MSR 0xE2[15] , CFG Lock bit Disabled : Disables CFG Lock (Default setting)

4.3.6 SATA Configuration

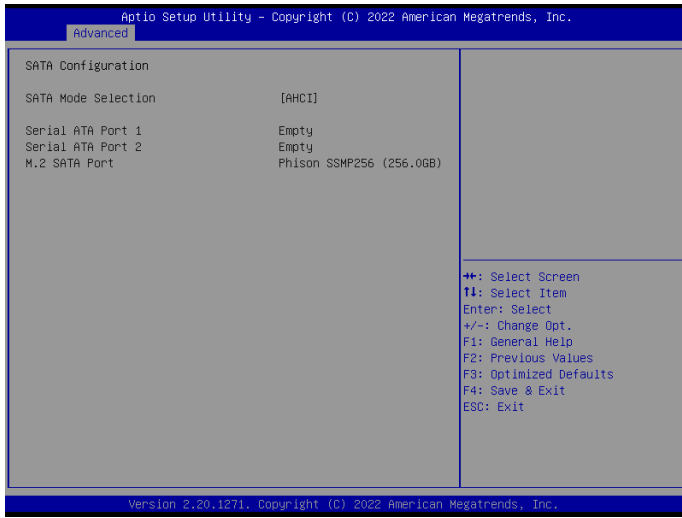

Item	Description
SATA Mode Selection	AHCI (Default setting)
Serial ATA Port 1 Serial ATA Port 2	shows 2.5" SATA HDD/SSD information
M.2 SATA Port	shows M.2 SATA interface SSD information

4.3.7 CSM Configuration

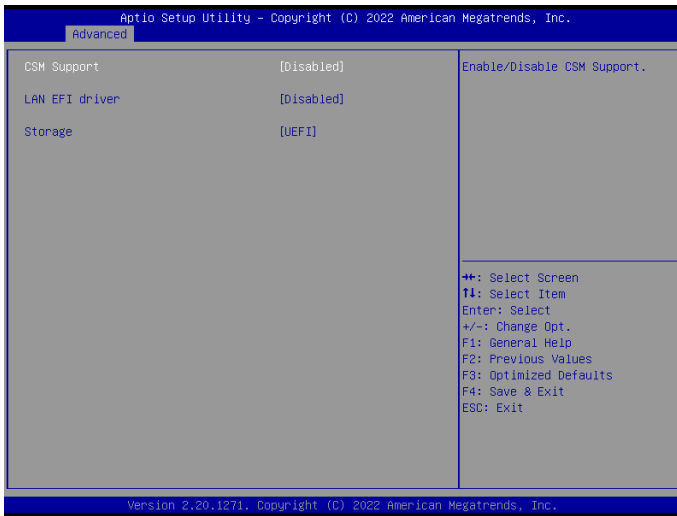

Item	Description
CSM Support	Choose UEFI or Legacy Mode Disabled : UEFI Mode only (Default setting) Enabled : Enables Legacy Mode feature
LAN EFI driver	When system is power on, install LAN driver under UEFI mode Disabled : Disables UEFI Network stack (Default setting) Enabled : Enables UEFI Network stack
Storage	Controls the execution of UEFI and Legacy Storage OpROM Option items : Do not launch, UEFI (Default setting), Legacy

4.3.8 AMI Graphic Output Protocol Policy

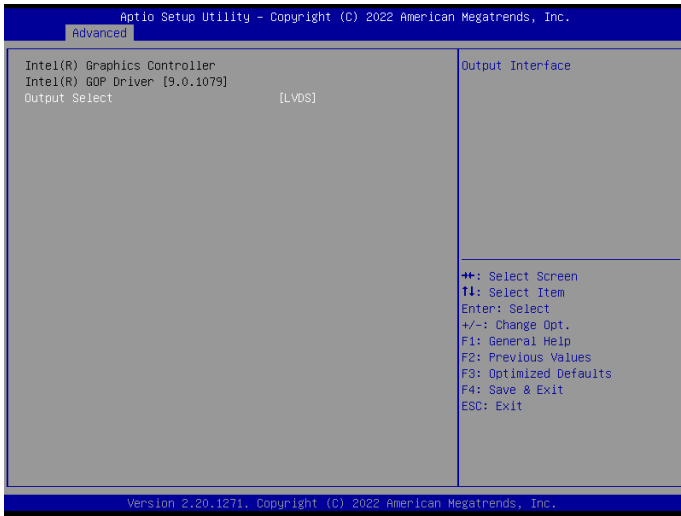

Item	Description
Output Select	Choose default monitor output when there are more than one monitor plugged on the motherboard.

4.3.9 Digital IO Port Configuration

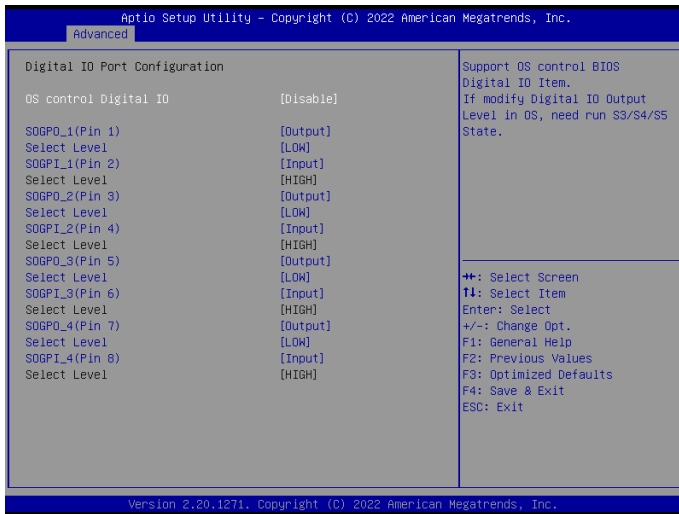

Item	Description
OS control Digital IO	<p>Disabled : If Digital IO Output value/level is modified in OS, they will not be memorized and kept. (Default setting)</p> <p>Enabled : If Digital IO Output value/level is modified in OS, they will be memorized and kept.</p>
SOGPO_1 (Pin 1) SOGPI_1 (Pin 2) SOGPO_2 (Pin 3) SOGPI_2 (Pin 4) SOGPO_3 (Pin 5) SOGPI_3 (Pin 6) SOGPO_4 (Pin 7) SOGPI_4 (Pin 8)	Configure Digital IO Input or Output values for each pin.

4.4 Chipset

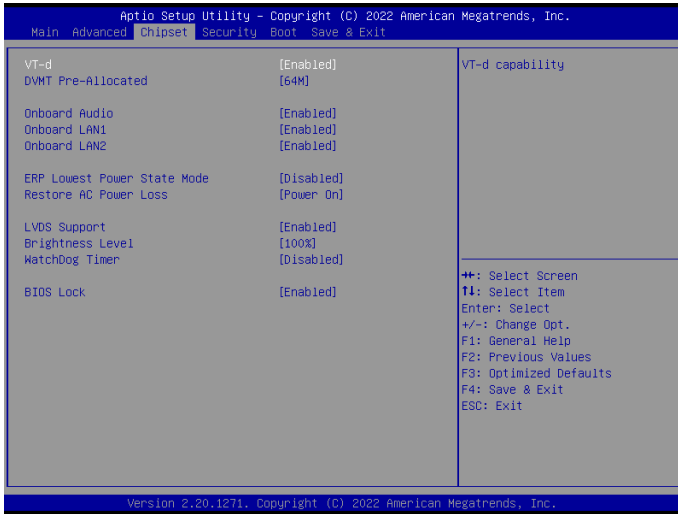

Item	Description
VT-d	Enabled : Enables VT-d function (Default setting) Disabled : Disables VT-d function
DVMT Pre-Allocated	Use DVMT Pre-Allocated to set the amount of system memory which is installed to the integrated graphics processor Option items : 32M , 64M(Default setting), 128M, 256M
Onboard Audio	Enable/Disable onboard audio controller Enabled : Enables onboard audio controller (Default setting) Disabled : Disables onboard audio controller
Onboard LAN1 Onboard LAN2	Enable/Disable onboard LAN controller Enabled : Enables onboard LAN controller (Default setting) Disabled : Disables onboard LAN controller
ERP Lowest Power State Mode	Enable/Disable power saving funtion Enabled : Enables ERP Lowest Power State Mode Disabled : Disabled ERP Lowest Power State Mode (Default setting)
Restore AC Power Loss	To set which option the system should returns if a sudden power loss occurred Power on : System power on when the power is back (Default setting) Power off : Do not power on when the power is back Last state : Restore the system to the state before power loss occurs

LVDS Support	Disabled : Disables LVDS Support Enabled : Enables LVDS Support (Default setting)
Brightness Level	To modified the backlight brightness of the LVDS panel Option items : 10%, 20%, 30%, 40%, 50%, 60%, 70%, 80%, 90%, 100% (Default Setting)
Watchdog Timer	Enable/Disable Watchdog Timer function Enabled : Enables Watchdog Timer function Disabled : Disabled Watchdog Timer function (Default setting)
BIOS Lock	Enable/Disable BIOS Lock function Enabled : Enables BIOS Lock function (Default setting) Disabled : Disabled BIOS Lock funtion

4.5 Security

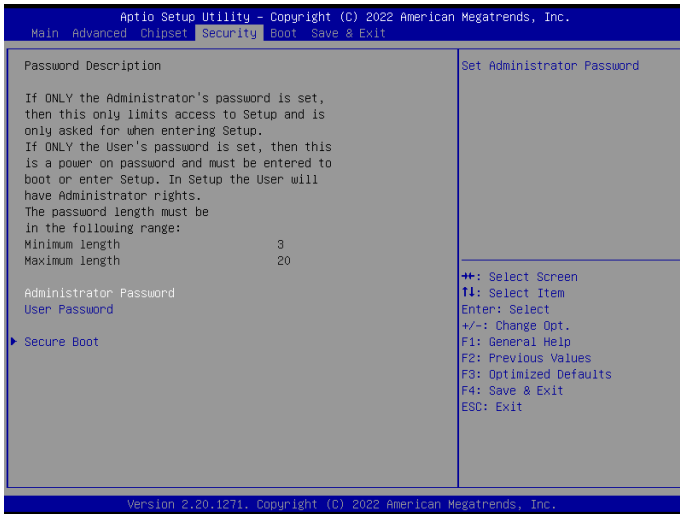

Item	Description
Administrator Password	To set up Administrator's password Minimum length : 3 Maximum length : 20
User Password	To set up User's password Minimum length : 3 Maximum length : 20
Secure Boot	Press <Enter> to configure the advanced items

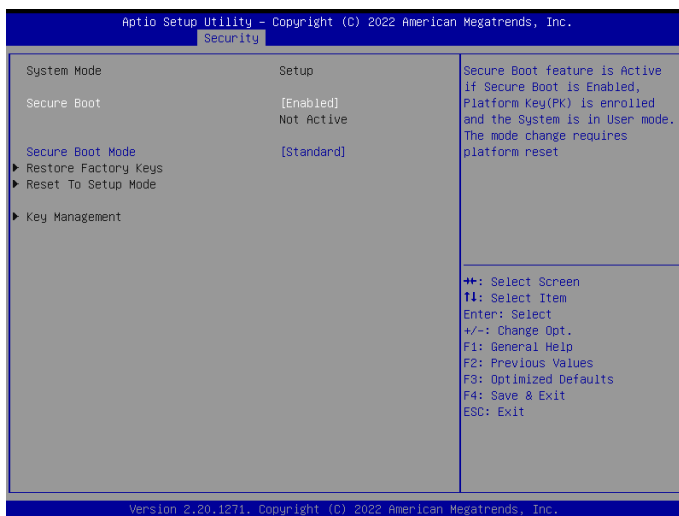

Item	Description
Secure Boot	Secure Boot requires all the applications that are running during the booting process to be pre-signed with valid digital certificates Enabled : Enables Secure Boot function (Default setting) Disabled : Disables Secure Boot function
Secure Boot Mode	Standard : Standard mode (Default setting) Custom : Custom mode
Restore Factory Keys	If set secure boot mode to "Custom mode" : Yes : Agree to restore factory settings No : Cancel to restore factory settings
Reset To Setup Mode	Yes : Agree to setup mode No : Cancel to setup mode
Key Management	If set secure boot mode to "Custom mode" : Enables expert users to modify Secure boot policy variables without full authentication Press <Enter> to configure the advanced items



Item	Description	Item	Description
Factory Key Provision	Install factory default Secure Boot keys after the platform reset and while the system is in Setup mode Enabled : Enables Factory Key Provision (Default setting) Disabled : Disables Factory Key Provision	Platform Key (PK)	These items allows you to enroll factory defaults or load Certificates from a file.
Restore Factory Keys	To restore factory settings Yes : Agree to restore factory settings No : Cancel to restore factory settings	Key Exchange Keys	
Reset To Setup Mode	Yes : Agree to setup mode No : Cancel to setup mode	Authorized Signatures	
Export Secure Boot variables	Copy NVRAM content of Secure Boot variables to files in a root folder on a file system device	Forbidden Signatures	
Enroll Efi Image	Allow the image to run in Secure Boot mode	Authorized TimeStamps	
Remove 'UEFI CA' from DB	To remove 'UEFI CA' from database Yes : Agree to remove 'UEFI CA' from database No : Cancel to remove 'UEFI CA' from database	OsRecovery Signatures	
Restore DB defaults	Restore DB variables to factory defaults Yes : Agree to restore DB defaults No : Cancel to restore DB defaults		

4.6 Boot

This Boot menu allows you to set/change system boot options

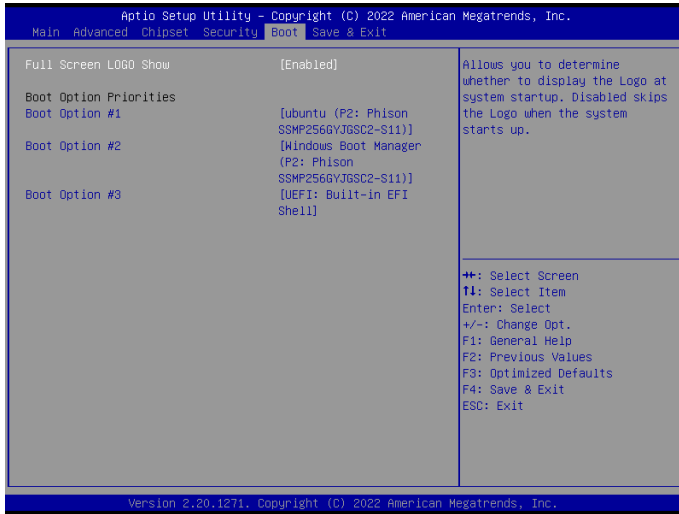

Item	Description
Full Screen LOGO Show	Enable/Disable full screen LOGO show on POST screen Enabled : Enables Full screen LOGO Show on POST screen Disabled : Disables Full screen LOGO Show on POST screen (Default setting)
Boot Option #1 Boot Option #2 Boot Option #3	Shows the information of the storage that be installed in the system Choose/set the boot priority

4.7 Save & Exit

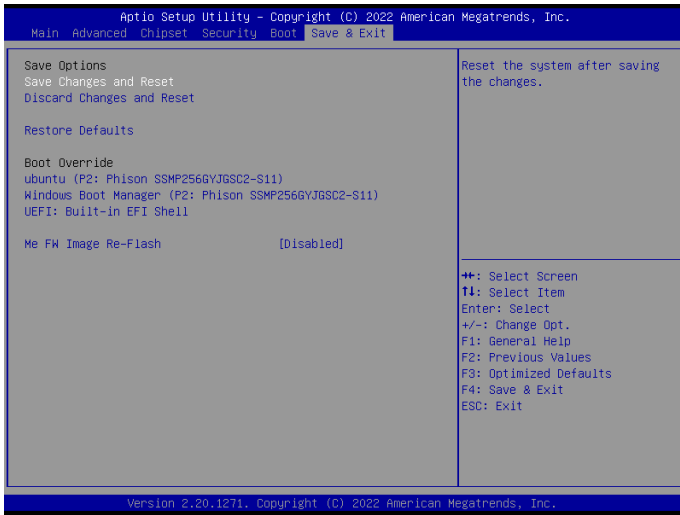

Item	Description
Save Changes and Reset	After configuring all the options that you wish to change, choose this option to save all the changes and reboot the system Yes : Agree to save and reset No : Cancel to save and reset
Discard Changes and Reset	Choose this option to reboot the system without saving any changes Yes : Agree to discard changes and reset No : Cancel to discard changes and reset
Restore Defaults	Restore/Load default values for all the setup options Yes : Agree to load optimized defaults No : Cancel to load optimized defaults
Me FW Image Re-Flash	Enable/Disable Me FW image re-flash function Enabled : Enables Me FW image re-flash function Disabled : Disables Me FW image re-flash function (Default setting)