

# I-8094-G / I-9094

## High-speed 4-axis Motion Control Module

2

3

PAC Solutions



### Features:

- Independent 4-axis motion control
- Support for hand wheel and jog functions
- 2/3-axis linear / 2-axis circular interpolation function
- Continuous interpolation function
- Programmable T/S-curve acceleration and deceleration
- A maximum pulse output rate of 4 Mpps for each axis
- Pulse Output Types: CW/CCW or PULSE/DIR
- 32-bit encoder counter for each axis
- Encoder Pulse Input Types: A/B Phase or Up/Down
- Programmable automatic homing for each axis
- Position comparison management and software limits
- A wide range of synchronous actions (event-triggered actions)

### Introduction:

The **I-8094** and **I-9094** are **4-axis** stepping/pulse-type servo motor control modules that can be used on the programmable automation controller (PAC) series provided by ICPDAS, and are suitable for general-purpose motion applications. In addition to their wide speed range, these intelligent motion controllers also have a variety of motion control functions built in, such as 2/3-axis linear interpolation, 2-axis circular interpolation, T/S-curve acceleration/deceleration, a range of synchronous actions, automatic homing, and others.

A major advantage is that the majority of the **I-8094 / I-9094** motion control functions are performed by the high-performance motion ASIC with little load on the processor. While driving the motors, the motion status, and the status of other I/O channels on the PAC modules, can still be monitored. As the CPU loading requirements of the **I-8094 / I-9094** is minimal, one or more motion modules may be used with a single PAC controller. ICP DAS also provides a wide range of functions and examples that can be used to reduce the need for additional programming, making it a highly cost-effective solution for motion control application developers.

### Specifications:

Number of Axes	4
Maximum Pulse Output Rate	4 MHz
Command Type	Pulse Command
Resolution	32-bit
Pulse Output Mode	CW/CCW, PULSE/DIR
Operation Mode	Semi-closed Loop
Linear Interpolation	Any 2 to 3 of 4 axes
Circular Interpolation	Any 2 axes
Speed Curve Profile	T/S-curve
Motion Relative I/O	Home, LMT+/-, NHOME, EMG, INP, ALM, SVON
Synchronous Action	10 activation factors and 14 actions
Ring Counter Mode	32-bit
Position Control Mode	Incremental mode and absolute mode
Position Compare Trigger	10 KHz
Encoder Interface	A/B pulse, Up/Down
Encoder Counter	32-bit
Encoder Rate	4 MHz
Digital Input Channels	-
Digital Output Channels	-
I/O Isolation (with DN-8468)	2500 Vrms optical isolation
Connector	68-pin SCSI-II connector
Power Consumption	+5 V @ 500 mA
Environmental	
Operating Temperature	-20 ~ +75°C
Storage Temperature	-30 ~ +85°C
Ambient Relative Humidity	5 ~ 90% RH, non-condensing

## Features of Motion Function:

2 or 3-Axis Linear Interpolation

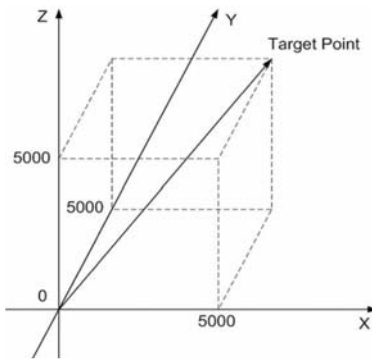

2-Axis Circular Interpolation

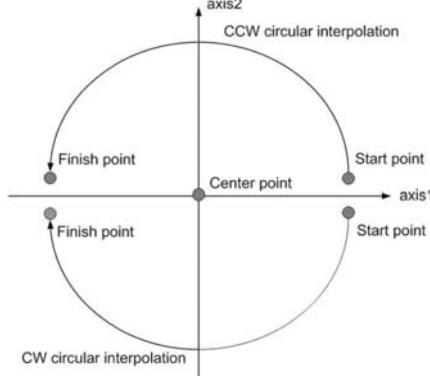

Continuous interpolation

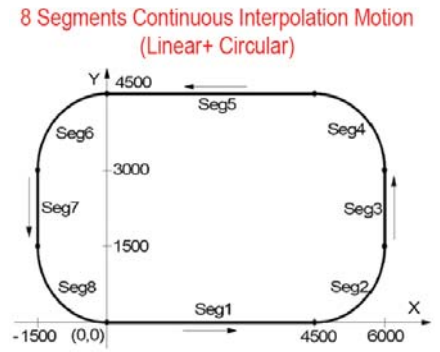

High Speed Position Compare

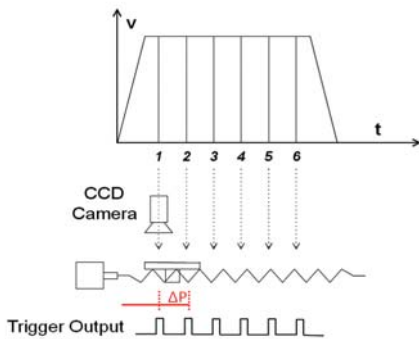

4 Steps Automatic Home Searching

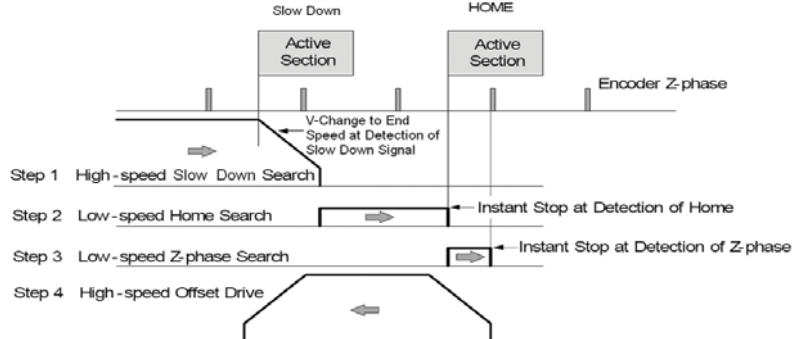

## Dimensions:

Units: mm

I-8094-G

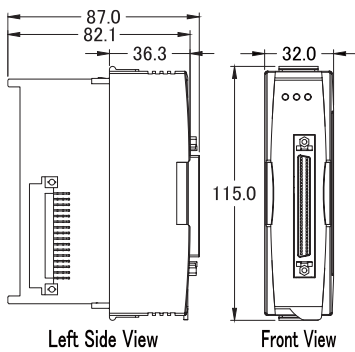

I-9094

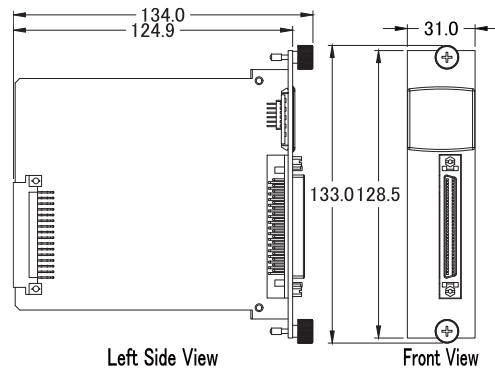

## Ordering Information / Accessories:

Module	Description
<b>I-8094-G</b>	High-speed 4-axis Motion Control Module (For XP-8000/WP-8000 PAC)
<b>I-9094</b>	High-speed 4-axis Motion Control Module (For XP-9000/WP-9000 PAC)
DN-8468UB	Photo-isolated Universal Snap-on Wiring Terminal Board
DN-8468GB	Photo-isolated General Purpose Wiring Terminal Board
DN-8468MB	Photo-isolated Snap-on Wiring Terminal Board for Mitsubishi MELSERVO-J2 Servo Amplifier
DN-8468PB	Photo-isolated Snap-on Wiring Terminal Board for Panasonic MINAS A4/A5 Servo Amplifier
DN-8468YB	Photo-isolated Snap-on Wiring Terminal Board for Yaskawa Sigma II/III/V Servo Amplifier
DN-8468DB	Photo-isolated Snap-on Wiring Terminal Board for Delta ASDA-A Servo Amplifier
DN-8468FB	Photo-isolated Snap-on Wiring Terminal Board for Fuji FALDIC-W Servo Amplifier
CA-SCSI15-H2 / CA-SCSI30-H2 / CA-SCSI50-H2	68-pin SCSI-II Male-Male Connector Cable, Length 1.5 M / 3.0 M / 5.0 M



PAC Solutions