



NEXCOM International Co., Ltd.

Mobile Computing Solutions

Vehicle Telematics Computer

VTC 6210

User Manual

Contents

Preface

Copyright	v
Disclaimer	v
Acknowledgements	v
Regulatory Compliance Statements	v
Declaration of Conformity.....	v
RoHS Compliance	vi
Warranty and RMA	vii
Technical Support and Assistance.....	x
Conventions Used in this Manual.....	x
Global Service Contact Information.....	xi
Package Contents.....	xiii

Chapter 1: Product Introduction

Physical Features.....	1
Front View.....	1
Rear View.....	1
Overview	2
Key Features	2
Hardware Specifications.....	3
Connector Numbering	5

Chapter 2: External Connectors Pinout Description

Event Button	6
LED Indicators (HDD, WWAN, Power & WLAN)	6

USB 3.0 Port.....	7
Reset	7
SIM1 and SIM2 Sockets	8
CFast.....	8
Line-out2.....	9
Mic2.....	9
Line-out1.....	10
Mic1.....	10
LAN1 and LAN2 Ports.....	11
VGA	11
USB 2.0 Ports	12
GPIO/CAN/OBDII.....	12
DisplayPort	13
DC Output	13
DC Input 9V-36V.....	14
COM3 (RS422/485)	14
COM2 RS-232 (RI/12V Selectable).....	15
COM1 RS-232 (RI/12V Selectable).....	15
MCU-DIO	16

Chapter 3: Jumpers and Switches

Before You Begin	17
Precautions	17
Jumper Settings	18
DIP Switch Settings	20
RTC Clear Selection	20

GPIO Pull-High Setup	20
COM1 RI/12VDC Selection	21
COM2 RI/12VDC Selection	21
MiniCard (CN26) Power Selection	22
WWAN Module Selection Table (For Wake-Up & Voice Functions on Mini-PCIe CN26)	23
Input Voltage Setup Selection	24
RTC Battery Connector	25
Debug 80 Port Connector	25
COM Port Connector (COM1 RS-232)	26
COM Port Connector (COM2 RS-232)	26
COM Port Connector (COM3 - RS422/485)	27
MCU-DIO Connector	27
Reset Button (Reserved)	28
Power Button Connector (Reserved)	28
SATA HDD Connector	29
OBDII Module Connector	29
Debug Port	30
GAL Download Port	30
GPS Connector	31
Internal WWAN SIM Card Socket (SIM 3) For CN27	31
MCU Download Port	32
Mini-PCIe (USB + PCIe)	33
Mini-PCIe (USB + PCIe)	34
Mini-PCIe (USB)	35
Mini-PCIe (USB)	36

Chapter 4: System Setup

Removing the Chassis Cover	37
Installing a SSD/HDD Drive	38
Installing a WLAN Module (Half Mini-PCIe)	40
Installing a WWAN Module	40

Installing a SO-DIMM	41
Installing a OBDII Module	42

Appendix A: Software Demo Utility for I/O Ports of Function Control

Menu Screen	43
1.1 Status	44
1.2 Input Voltage	44
1.3 Output Power	45
1.4 GPIO Setting	45
1.5 MCU GPIO Setting	46
1.6 WDT Setting	46
1.7 WWAN Module	47
1.8 Selection of RS-422 or RS-485 for COM3	47
1.9 Power Off Delay Time	47
1.10 Wake Up Function	48
1.11 CAN Bus Setting	48
1.12 Interface Power	49
1.13 Mini-PCIe Power	49

Appendix B: GPS Feature

uBlox-NEO M8 Overview	50
Technical Specifications	50

Appendix C: Signal Connection of DI/DO

GPIO Pinout Description	52
SW2 Setting	52
Digital Input	53
Digital Output	54

Appendix D: Signal Connection of MCU DI/DO and Event Button

MCU-DIO Pinout Description.....	55
Digital Input.....	55
Digital Output.....	56
Event Button.....	56
Pre-Alarm Function by Event Button, MCU-DI and MCU-DO	58
Setting up Pre-Alarm function	58
Activating Pre-Alarm function	59
Deactivating Pre-Alarm function	59
Activating Pre-Alarm Function	60
(For Event Button).....	60
(For MCU-DI2).....	60
Deactivating Pre-Alarm Function	61
(For Event Button).....	61
(For MCU-DI2).....	61

Appendix E: Vehicle Power Management Setup

External Power Output Setting.....	62
Startup and Shutdown Voltage Setting	62
Power-on Delay Setting.....	64
Power-off Delay Setting	66

Appendix F: OBDII Module Setup and Command

OBDII Module	68
VIOX-CAN01 Setup.....	68
AT Command Summary.....	69
Simple Data Protocol: (ASCII CODE)	70
Simple Data Protocol: (HEX CODE)	71
J1939 Raw Data Protocol (HEX CODE)	72
J1708 Raw Data Protocol (HEX CODE)	72

J1939 Packaged Messages Protocol	73
J1708 Packaged Messages Protocol	81
J1708 Command Example	85

Appendix G: Power Consumption86

Preface

Copyright

This publication, including all photographs, illustrations and software, is protected under international copyright laws, with all rights reserved. No part of this manual may be reproduced, copied, translated or transmitted in any form or by any means without the prior written consent from NEXCOM International Co., Ltd.

Disclaimer

The information in this document is subject to change without prior notice and does not represent commitment from NEXCOM International Co., Ltd. However, users may update their knowledge of any product in use by constantly checking its manual posted on our website: <http://www.nexcom.com>. NEXCOM shall not be liable for direct, indirect, special, incidental, or consequential damages arising out of the use of any product, nor for any infringements upon the rights of third parties, which may result from such use. Any implied warranties of merchantability or fitness for any particular purpose is also disclaimed.

Acknowledgements

VTC 6210 is a trademark of NEXCOM International Co., Ltd. All other product names mentioned herein are registered trademarks of their respective owners.

Regulatory Compliance Statements

This section provides the FCC compliance statement for Class B devices and describes how to keep the system CE compliant.

Declaration of Conformity

FCC

This equipment has been tested and verified to comply with the limits for a Class B digital device, pursuant to Part 15 of FCC Rules. These limits are designed to provide reasonable protection against harmful interference when the equipment is operated in a commercial environment. This equipment generates, uses, and can radiate radio frequency energy and, if not installed and used in accordance with the instructions, may cause harmful interference to radio communications. Operation of this equipment in a residential area (domestic environment) is likely to cause harmful interference, in which case the user will be required to correct the interference (take adequate measures) at their own expense.

CE

The product(s) described in this manual complies with all applicable European Union (CE) directives if it has a CE marking. For computer systems to remain CE compliant, only CE-compliant parts may be used. Maintaining CE compliance also requires proper cable and cabling techniques.

RoHS Compliance



NEXCOM RoHS Environmental Policy and Status Update

NEXCOM is a global citizen for building the digital infrastructure. We are committed to providing green products and services, which are compliant with European Union RoHS (Restriction on Use of Hazardous Substance in Electronic Equipment) directive 2011/65/EU, to be your trusted green partner and to protect our environment.

RoHS restricts the use of Lead (Pb) < 0.1% or 1,000ppm, Mercury (Hg) < 0.1% or 1,000ppm, Cadmium (Cd) < 0.01% or 100ppm, Hexavalent Chromium (Cr6+) < 0.1% or 1,000ppm, Polybrominated biphenyls (PBB) < 0.1% or 1,000ppm, and Polybrominated diphenyl Ethers (PBDE) < 0.1% or 1,000ppm.

In order to meet the RoHS compliant directives, NEXCOM has established an engineering and manufacturing task force in to implement the introduction of green products. The task force will ensure that we follow the standard NEXCOM development procedure and that all the new RoHS components and new manufacturing processes maintain the highest industry quality levels for which NEXCOM are renowned.

How to recognize NEXCOM RoHS Products?

For existing products where there are non-RoHS and RoHS versions, the suffix "(LF)" will be added to the compliant product name.

All new product models launched after January 2013 will be RoHS compliant. They will use the usual NEXCOM naming convention.

Warranty and RMA

NEXCOM Warranty Period

NEXCOM manufactures products that are new or equivalent to new in accordance with industry standard. NEXCOM warrants that products will be free from defect in material and workmanship for 2 years, beginning on the date of invoice by NEXCOM. HCP series products (Blade Server) which are manufactured by NEXCOM are covered by a three year warranty period.

NEXCOM Return Merchandise Authorization (RMA)

- Customers shall enclose the “NEXCOM RMA Service Form” with the returned packages.
- Customers must collect all the information about the problems encountered and note anything abnormal or, print out any on-screen messages, and describe the problems on the “NEXCOM RMA Service Form” for the RMA number apply process.
- Customers can send back the faulty products with or without accessories (manuals, cable, etc.) and any components from the card, such as CPU and RAM. If the components were suspected as part of the problems, please note clearly which components are included. Otherwise, NEXCOM is not responsible for the devices/parts.
- Customers are responsible for the safe packaging of defective products, making sure it is durable enough to be resistant against further damage and deterioration during transportation. In case of damages occurred during transportation, the repair is treated as “Out of Warranty.”
- Any products returned by NEXCOM to other locations besides the customers’ site will bear an extra charge and will be billed to the customer.

Repair Service Charges for Out-of-Warranty Products

NEXCOM will charge for out-of-warranty products in two categories, one is basic diagnostic fee and another is component (product) fee.

System Level

- Component fee: NEXCOM will only charge for main components such as SMD chip, BGA chip, etc. Passive components will be repaired for free, ex: resistor, capacitor.
- Items will be replaced with NEXCOM products if the original one cannot be repaired. Ex: motherboard, power supply, etc.
- Replace with 3rd party products if needed.
- If RMA goods can not be repaired, NEXCOM will return it to the customer without any charge.

Board Level

- Component fee: NEXCOM will only charge for main components, such as SMD chip, BGA chip, etc. Passive components will be repaired for free, ex: resistors, capacitors.
- If RMA goods can not be repaired, NEXCOM will return it to the customer without any charge.

Warnings

Read and adhere to all warnings, cautions, and notices in this guide and the documentation supplied with the chassis, power supply, and accessory modules. If the instructions for the chassis and power supply are inconsistent with these instructions or the instructions for accessory modules, contact the supplier to find out how you can ensure that your computer meets safety and regulatory requirements.

Cautions

Electrostatic discharge (ESD) can damage system components. Do the described procedures only at an ESD workstation. If no such station is available, you can provide some ESD protection by wearing an antistatic wrist strap and attaching it to a metal part of the computer chassis.

Safety Information

Before installing and using the device, note the following precautions:

- Read all instructions carefully.
- Do not place the unit on an unstable surface, cart, or stand.
- Follow all warnings and cautions in this manual.
- When replacing parts, ensure that your service technician uses parts specified by the manufacturer.
- Avoid using the system near water, in direct sunlight, or near a heating device.
- The load of the system unit does not solely rely for support from the rackmounts located on the sides. Firm support from the bottom is highly necessary in order to provide balance stability.
- The computer is provided with a battery-powered real-time clock circuit. There is a danger of explosion if battery is incorrectly replaced. Replace only with the same or equivalent type recommended by the manufacturer. Discard used batteries according to the manufacturer's instructions.

Installation Recommendations

Ensure you have a stable, clean working environment. Dust and dirt can get into components and cause a malfunction. Use containers to keep small components separated.

Adequate lighting and proper tools can prevent you from accidentally damaging the internal components. Most of the procedures that follow require only a few simple tools, including the following:

- A Philips screwdriver
- A flat-tipped screwdriver
- A grounding strap
- An anti-static pad

Using your fingers can disconnect most of the connections. It is recommended that you do not use needlenose pliers to disconnect connections as these can damage the soft metal or plastic parts of the connectors.

Warning!

1. Handling the unit: carry the unit with both hands and handle it with care.
2. Maintenance: to keep the unit clean, use only approved cleaning products or clean with a dry cloth.
3. CompactFlash: Turn off the unit's power before inserting or removing a CompactFlash storage card.
4. SIM: Do not insert or remove the SIM card when the **system is powered** on. Always **power** off the **system** before inserting or removing the SIM card.

Safety Precautions

- Read these safety instructions carefully.
- Keep this User Manual for later reference.
- Disconnect this equipment from any AC outlet before cleaning. Use a damp cloth. Do not use liquid or spray detergents for cleaning.
- For plug-in equipment, the power outlet socket must be located near the equipment and must be easily accessible.
- Keep this equipment away from humidity.
- Put this equipment on a stable surface during installation. Dropping it or letting it fall may cause damage.
- Do not leave this equipment in either an unconditioned environment or in a above 40°C storage temperature as this may damage the equipment.
- The openings on the enclosure are for air convection to protect the equipment from overheating. DO NOT COVER THE OPENINGS.
- Make sure the voltage of the power source is correct before connecting the equipment to the power outlet.
- Place the power cord in a way so that people will not step on it. Do not place anything on top of the power cord. Use a power cord that has been approved for use with the product and that it matches the voltage and current marked on the product's electrical range label. The voltage and current rating of the cord must be greater than the voltage and current rating marked on the product.
- All cautions and warnings on the equipment should be noted.
- If the equipment is not used for a long time, disconnect it from the power source to avoid damage by transient overvoltage.
- Never pour any liquid into an opening. This may cause fire or electrical shock.
- Never open the equipment. For safety reasons, the equipment should be opened only by qualified service personnel.
- If one of the following situations arises, get the equipment checked by service personnel:
 - a. The power cord or plug is damaged.
 - b. Liquid has penetrated into the equipment.
 - c. The equipment has been exposed to moisture.
 - d. The equipment does not work well, or you cannot get it to work according to the user's manual.
 - e. The equipment has been dropped and damaged.
 - f. The equipment has obvious signs of breakage.
- Do not place heavy objects on the equipment.
- The unit uses a three-wire ground cable which is equipped with a third pin to ground the unit and prevent electric shock. Do not defeat the purpose of this pin. If your outlet does not support this kind of plug, contact your electrician to replace your obsolete outlet.
- CAUTION: DANGER OF EXPLOSION IF BATTERY IS INCORRECTLY REPLACED. REPLACE ONLY WITH THE SAME OR EQUIVALENT TYPE RECOMMENDED BY THE MANUFACTURER. DISCARD USED BATTERIES ACCORDING TO THE MANUFACTURER'S INSTRUCTIONS.
- The computer is provided with CD drives that comply with the appropriate safety standards including IEC 60825.

Technical Support and Assistance

1. For the most updated information of NEXCOM products, visit NEXCOM's website at www.nexcom.com.
2. For technical issues that require contacting our technical support team or sales representative, please have the following information ready before calling:
 - Product name and serial number
 - Detailed information of the peripheral devices
 - Detailed information of the installed software (operating system, version, application software, etc.)
 - A complete description of the problem
 - The exact wordings of the error messages

Warning!

1. Handling the unit: carry the unit with both hands and handle it with care.
2. Maintenance: to keep the unit clean, use only approved cleaning products or clean with a dry cloth.
3. CompactFlash: Turn off the unit's power before inserting or removing a CompactFlash storage card.

Conventions Used in this Manual



Warning:

Information about certain situations, which if not observed, can cause personal injury. This will prevent injury to yourself when performing a task.



Caution:

Information to avoid damaging components or losing data.



Note:

Provides additional information to complete a task easily.

Global Service Contact Information

Headquarters

NEXCOM International Co., Ltd.

9F, No. 920, Chung-Cheng Rd.,
ZhongHe District, New Taipei City, 23586,
Taiwan, R.O.C.

Tel: +886-2-8226-7786

Fax: +886-2-8226-7782

www.nexcom.com

Asia

Taiwan

NexAIoT Co., Ltd.

Taipei Office

13F, No.920, Chung-Cheng Rd.,
ZhongHe District,
New Taipei City, 23586, Taiwan, R.O.C.

Tel: +886-2-8226-7796

Fax: +886-2-8226-7792

Email: sales@nexcom.com.tw

www.nexcom.com.tw

NexAIoT Co., Ltd.

Taichung Office

16F, No.250, Sec. 2, Chongde Rd.,
Beitun Dist.,

Taichung City 406, R.O.C.

Tel: +886-4-2249-1179

Fax: +886-4-2249-1172

Email: sales@nexcom.com.tw

www.nexcom.com.tw

NexCOBOT Taiwan Co., Ltd.

13F, No.916, Chung-Cheng Rd.,
ZhongHe District,
New Taipei City, 23586, Taiwan, R.O.C.

Tel: +886-2-8226-7796

Fax: +886-2-8226-7792

Email: sales@nexcom.com.tw

www.nexcom.com.tw

GreenBase Technology Corp.

13F, No.922, Chung-Cheng Rd.,
Zhonghe Dist.,
New Taipei City, 23586, Taiwan, R.O.C.

Tel: +886-2-8226-7786

Fax: +886-2-8226-7900

Email: sales@nexcom.com.tw

www.nexcom.com.tw

China

NEXSEC Incorporated

Floor 5, No.4, No.7 fengxian middle Rd.,
(Beike Industrial Park), Haidian District,
Beijing, 100094, China

Tel: +86-10-5704-2680

Fax: +86-10-5704-2681

Email: sales@nexcom.cn

www.nexcom.cn

NEXCOM Shanghai

Room 603/604, Huiyinmingzun Plaza Bldg., 1,
No. 609, Yunlin East Rd.,
Shanghai, 200062, China
Tel: +86-21-5278-5868
Fax: +86-21-3251-6358
Email: sales@nexcom.cn
www.nexcom.cn

NEXCOM Surveillance Technology Corp.

Floor 5, Building C, ZhenHan Industrial Zone,
GanKeng Community, Buji Street,
LongGang District,
ShenZhen, 518112, China
Tel: +86-755-8364-7768
Fax: +86-755-8364-7738
Email: steveyang@nexcom.com.tw
www.nexcom.cn

NEXCOM United System Service

Room 603/604, Huiyinmingzun Plaza Bldg. 1,
No. 609, Yunlin East Rd.,
Shanghai, 200062, China
Tel: +86-21-5278-5868
Fax: +86-21-3251-6358
Email: renwang@nexcom.com.tw
www.nexcom.cn

NEXGOL

1st Floor, Building B4, Electronic 2nd Area,
(Phoenix Lake Industrial Park), Yongchuan Dist.,
Chongqing City, 402160, China
Tel: +86-23-4960-9080
Fax: +86-23-4966-5855
Email: sales@nexcobot.com
www.nexgol.com/NexGoL

Beijing NexGemo Technology Co.,Ltd.

5th Floor, Gemotech Building, No.1, Development Rd.,
Changping International Information Industry Base,
Changping District,
Beijing, 102206, China
Tel: +86-10-8190-9399
Fax: +86-10-8190-9456

Japan**NEXCOM Japan**

9F, Tamachi Hara Bldg.,
4-11-5, Shiba Minato-ku,
Tokyo, 108-0014, Japan
Tel: +81-3-5419-7830
Fax: +81-3-5419-7832
Email: sales@nexcom-jp.com
www.nexcom-jp.com

Europe**United Kingdom
NEXCOM EUROPE**

10 Vincent Avenue,
Crownhill Business Centre,
Milton Keynes, Buckinghamshire
MK8 0AB, United Kingdom
Tel: +44-1908-267121
Fax: +44-1908-262042
Email: sales.uk@nexcom.eu
www.nexcom.eu

**America
USA****NEXCOM USA**

2883 Bayview Drive,
Fremont CA 94538, USA
Tel: +1-510-656-2248
Fax: +1-510-656-2158
Email: sales@nexcom.com
www.nexcom.com

Package Contents

Before continuing, verify that the VTC 6210 package that you received is complete. Your VTC 6210 package should have all the items listed in the following table.

Item	P/N	Name	Specification	Qty
1	4NCPF00204X00	Terminal Blocks 2P PHOENIX CONTACT:1777989	5.08mm Female DIP Green	1
2	4NCPM00302X00	Terminal Blocks 3P PHOENIX CONTACT:1777992	5.08mm Male DIP Green	1
3	4NCPM01601X00	Terminal Blocks 2x8 ANYTEK:KD161051A000G	3.5mm Male 16P 180D Plug Green	1
4	50311F0110X00	Flat Head Screw Long FEI:F3x5ISO+NYLOK NIGP	F3x5 NI NYLOK	4
5	6012200052X00	PE Zipper Bag #8	170x240mm, w/China RoHS Symbol	1
6	6012200053X00	PE Zipper Bag #3	100x70mm, w/China RoHS Symbol	1
7	60233PW134X00	Power Cable for VTK33B SMBus Signal EDI:356206060201-RS	ATX POWER Con. 6P TO 6P Pitch:4.2mm L:200mm	1
8	60233SAM05X00	GPS Antenna ARKNAV:A-130 GPS Antenna 5M SMA180P R1 L3	For VTC 5M/SMA180P	1
9	602DCDA002X00	VTC6210-BK DVD Driver VER:1.0	JCL	1

Ordering Information

The following provides ordering information for VTC 6210.

- **VTC 6210-BK (P/N : 10V00621000X0)**

Intel® Atom™ processor E3845 1.91GHz CPU, 2GB DDR3L SO-DIMM, VGA/DP output, 2 LAN, 2x RS-232, 1x RS-422/485, 8x GPIO, 3x USB, 12VDC output

Chapter 1: Product Introduction

Physical Features

Front View

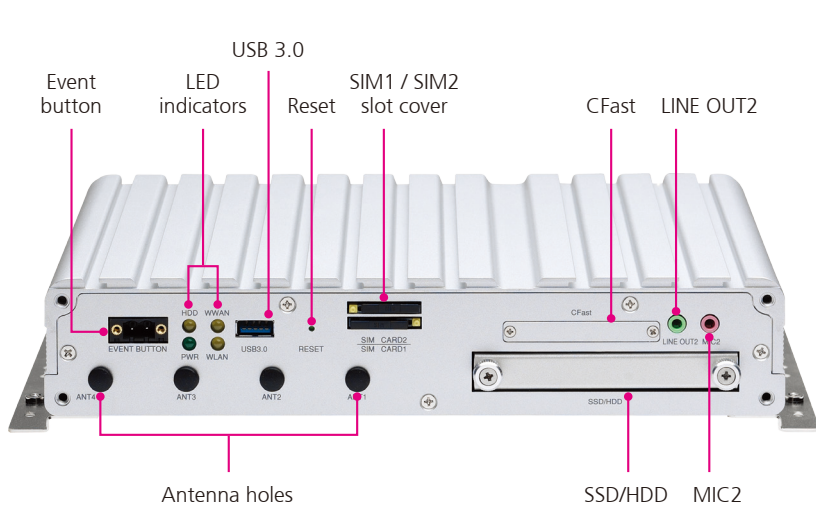

Rear View

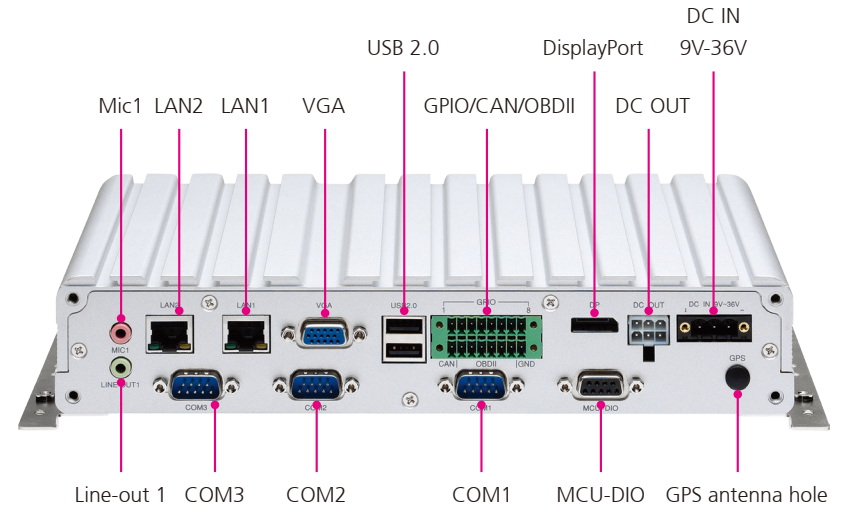

Overview

VTC 6210, based on Intel® Core™ quad core processor E3845 (1.91GHz), is specifically designed for the harsh in-vehicle environment. It allows VTC 6210 to comply with stringent MIL-STD-810G military standard in rugged, fanless and compact mechanism. VTC 6210 provides complete communication capability between automotive and computer with build-in CAN BUS 2.0B interface. Optional OBDII interface (J1939/J1708) is also available for vehicle diagnostics. VTC 6210 features rich PAN, WLAN and WWAN wireless connectivity. With three SIM cards support, VTC 6210 allows three SIM cards backup each other for a better connectivity quality by software. In addition, three SIM cards and dual WWAN modules architecture can increase the bandwidth for a faster data transmission speed. Not only data transmission, VTC 6210 also supports two-way voice communication. Equipped with intelligent power management, VTC 6210 can be waked on by ignition, RTC timer or SMS message remotely. By integrating the variety of I/O ports and 4x Mini-PCIe sockets expansibility, VTC 6210 keeps the flexibility to meet the demand for different telematics applications, such as infotainment, fleet management, dispatching system and video surveillance.

Key Features

- Intel® Atom™ processor quad core E3845, 1.91GHz
- Three SIM cards + dual WWAN modules support
- Built-in U-blox M8N GPS, optional Dead Reckoning support
- Built-in CAN Bus 2.0B. Optional CAN/OBDII module (CAN Bus 2.0B or OBDII SAE J1939)
- Wake on RTC/SMS via WWAN module
- Compliant with MIL-STD-810G
- 4x Mini-PCIe socket expansion
- Programmable 8x GPIO
- Voice communication via WWAN module

Hardware Specifications

CPU

- Intel® Atom™ processor quad core E3845, 1.91GHz

Memory

- 1x 204-pin DDR3L SO-DIMM socket support 1066MHz/1333MHz up to 8GB. Default 2GB

Storage

- 1x 2.5" SSD/HDD SATA 2.0 (externally accessible, optional lockable storage available)
- 1x CFast (externally accessible)

Expansion

- 1x full size Mini-PCIe socket (USB 2.0)
- 1x full size Mini-PCIe socket (USB 2.0)
- 1x full size Mini-PCIe socket (USB 2.0 + PCIe)
- 1x half size Mini-PCIe socket (USB 2.0 + PCIe)

GNSS Function

- 1x u-blox NEO-M8N module (support GPS/Gloness/QZSS/Galileo/Beidou) or optional module with Dead Reckoning
- Built-in G-sensor

I/O Interface-Front

- 4x LED for power, storage, WWAN, WLAN
- 2x externally accessible SIM card socket (selectable)
- 1x phone jack 3.5mm for 1x Mic-in
- 1x phone jack 3.5mm for 1x Line-out
- 1x externally accessible 2.5" SATA 2.0 SSD/HDD tray
- 1x externally accessible CFast card socket with cover
- 1x event button (trigger type)
- 1x reset button

- 1x type A USB 3.0 compliant host, supporting system boot up
- 4x antenna hole for WWAN/WLAN/BT

I/O Interface-Rear

- 1x 9~36VDC input with ignition and 19W typical power consumption
- 2x type A USB 2.0 compliant host, supporting system boot up
- 2x RJ45 10/100/1000 Fast Ethernet with LED
- 1x phone jack 3.5mm for 1x Mic-in
- 1x phone jack 3.5mm for 1x Line-out
- 1x DB-15 VGA, resolution up to 2560 x 1600 @60Hz
- 1x DP port, resolution up to 2560 x 1600 @60Hz
- 1x antenna hole for GPS
- 2x DB-9 RS-232 (RV/12V selectable)
- 1x DB-9 RS-422/485
- 1x DB-9 for CAN 2.0B (optional CAN Bus 2.0B Mini-PCIe card), 2x MCU-DI and 2x MCU-DO
- 1x 16-pin terminal block
 - 1x CAN Bus 2.0B (on board)
 - 1x optional CAN/OBDII module (CAN Bus 2.0B or OBDII SAE J1939)
 - 8x GPIO (Programmable digital input and digital output)
 - Input Voltage (internal type): 5VDC TTL (default)
 - Input Voltage (source type): 3~12VDC
 - Digital Output (sink type): 5VDC TTL (default), max current: 20mA
 - Digital Output (source type): 3~24VDC, max current: 150mA
- 1x 12VDC output (2A), SM Bus

Power Management

- Selectable boot-up & shut-down voltage for low power protection by software
- Setting 8-level power on/off delay time by software
- Status of ignition and low voltage can be detected by software
- Support S3/S4 suspend mode

Operating System

- Windows 8, WES8
- Windows 7, WES8
- Fedora

Dimensions

- 260 mm (W) x 176 mm (D) x 50 mm (H) (10.24" x 6.93" x 1.97")
- Weight : 2.1kg

Environment

- Operating temperatures: -30°C to 70°C (w/industrial SSD) with air flow
-20°C to 50°C (w/commercial HDD) with air flow
- Storage temperatures: -35°C to 85°C
- Relative humidity: 10% to 90% (non-condensing)
- Vibration (random):
1g@5~500 Hz (in operation, HDD), 2g@5~500 Hz (in operation, SSD)
- Vibration (SSD/HDD):
Operating: MIL-STD-810G, Method 514.6, Category 4, common carrier
US highway truck vibration exposure
Storage: MIL-STD-810G, Method 514.6, Category 24, minimum
integrity test
- Shock (SSD/HDD):
Operating: MIL-STD-810G, Method 516.6, Procedure I, functional
shock=20g
Non-operating: MIL-STD-810G, Method 516.6, Procedure V, crash
hazard shock test=75g

Certifications

- CE approval
- FCC Class B
- E13 Mark

Connector Numbering

The following diagrams indicate the numbers of the connectors. Use these numbers to locate the connectors' respective pinout assignments on chapter 2 of the manual.

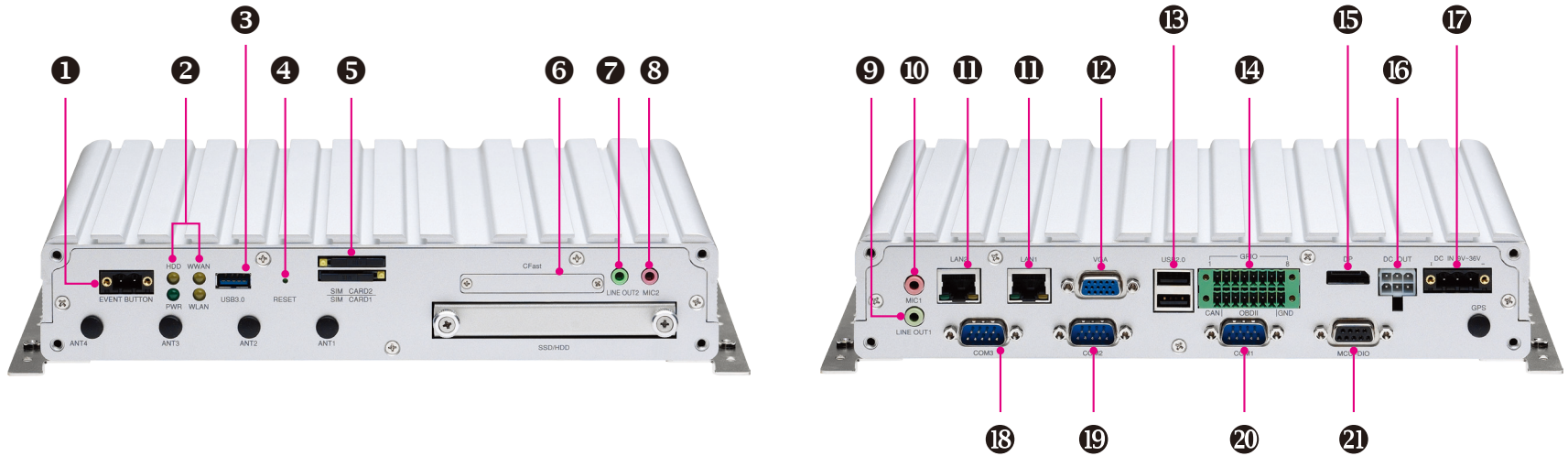

Chapter 2: External Connectors Pinout Description

Event Button

Connector Number: 1



Pin	Definition
1	Event Input
2	GND

LED Indicators (HDD, WWAN, Power & WLAN)

Connector Number: 2

HDD WWAN

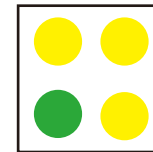

PWR WLAN

LED	LED Behavior
HDD	Light On: HDD/SSD Active
PWR	Light On: Power On Light Off: Power Off
WWAN	Blinking: Active
WLAN	Blinking: Active

USB 3.0 Port

Connector Number: 3

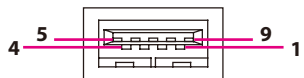

Pin	Definition	Pin	Definition
1	5V	2	USB_N
3	USB_P	4	GND
5	USB3_RXN	6	USB3_RXP
7	GND	8	USB3_TXN
9	USB3_TXP		

Reset

Connector Number: 4

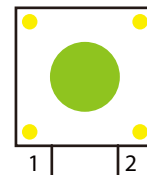

Pin	Definition
1	GND
2	RESET

SIM1 and SIM2 Sockets

Connector Number: 5

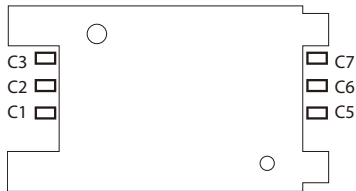

Pin	Definition	Pin	Definition
C1	UIM1_PWR2	C5	GND
C2	UIM1_RST2	C6	NC
C3	UIM1_CLK2	C7	UIM1_DAT2

CFast

Connector Number: 6

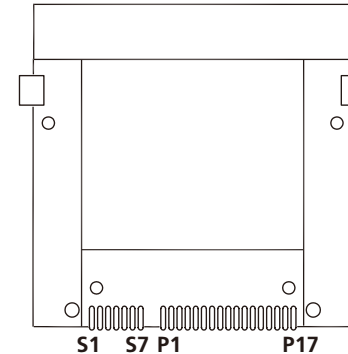

Pin	Definition	Pin	Definition
S1	GND	PC6	NC
S2	SATA_TX1+	PC7	GND
S3	SATA_TX1-	PC8	CFAST_LED1_C
S4	GND	PC9	CFAST_LED2_C
S5	SATA_RX1-	PC10	NC
S6	SATA_RX1+	PC11	NC
S7	GND	PC12	NC
PC1	CFAST_CDI	PC13	VCC3
PC2	GND	PC14	VCC3
PC3	NC	PC15	GND
PC4	NC	PC16	GND
PC5	NC	PC17	CFAST_CDO

Line-out2

Connector Number: 7

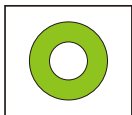

Pin	Definition	Pin	Definition
1	Headphone (mono)	2	Detect
3	NC	4	Headphone (mono)
5	GND	6	GND

Mic2

Connector Number: 8

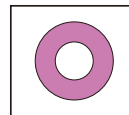

Pin	Definition	Pin	Definition
1	NC	2	Detect
3	NC	4	Mic-In (Right Channel) to WWAN module
5	GND	6	GND

Line-out1

Connector Number: 9

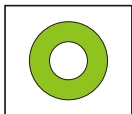

Pin	Definition	Pin	Definition
22	Left Channel	23	GND
24	Detect	25	Right Channel

Mic1

Connector Number: 10

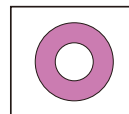

Pin	Definition	Pin	Definition
1	GND	2	Mic-In (Left Channel)
3	GND	4	Detect
5	NC	6	

LAN1 and LAN2 Ports

Connector Number: 11

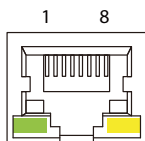

Pin	Definition	Pin	Definition
1	MDI0P	2	MDI0N
3	MDI1P	4	MDI2P
5	MDI2N	6	MDI1N
7	MDI3P	8	MDI3N
9	LED1-	10	LED1+
11	LED2-	12	LED2+

VGA

Connector Number: 12

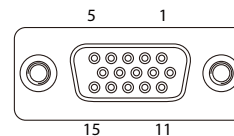

Pin	Definition	Pin	Definition
1	VGA_RED	2	VGA_GREEN
3	VGA_BLUE	4	VGA_GND
5	VGA_GND	6	VGA_GND
7	VGA_GND	8	VGA_GND
9	VGA +5V	10	VGA_GND
11	VGA_GND	12	VGA_DATA
13	VGA_HS	14	VGA_VS
15	VGA_CLK		

USB 2.0 Ports

Connector Number: 13

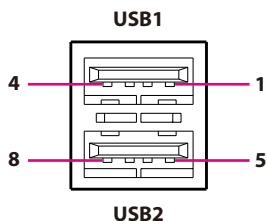

USB1 Pin Connector Definition

Pin	Definition	Pin	Definition
1	VCC	2	DATA1-
3	DATA1+	4	GND

USB2 Pin Connector Definition

Pin	Definition	Pin	Definition
5	VCC	6	DATA-
7	DATA+	8	GND

GPIO/CAN/OBDII

Connector Number: 14

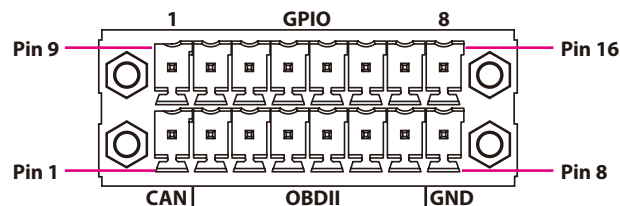

Pin	Definition	Pin	Definition
1	CAN2.0 SJA1000_H	9	GPIO1 (Default: GPI1)
2	CAN2.0 SJA1000_L	10	GPIO2 (Default: GPI2)
3	VI0B-CAN03-CAN2.0_L	11	GPIO3 (Default: GPI3)
4	VI0B-CAN03-CAN2.0_H	12	GPIO4 (Default: GPI4)
5	VI0B-CAN03-J1939_L	13	GPIO5 (Default: GPO1)
6	VI0B-CAN03-J1939_H	14	GPIO6 (Default: GPO2)
7	GND	15	GPIO7 (Default: GPO3)
8	GND	16	GPIO8 (Default: GPO4)

GPIO can be programmed by *S/W*.
Please refer to the source code in utility.

DisplayPort

Connector Number: 15

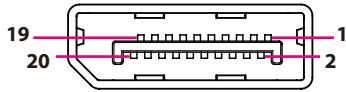

Pin	Definition	Pin	Definition
1	DPO_DATA0_P	2	GND
3	DPO_DATA0_N	4	DPO_DATA1_P
5	GND	6	DPO_DATA1_N
7	DPO_DATA2_P	8	GND
9	DPO_DATA2_N	10	DPO_DATA3_P
11	GND	12	DPO_DATA3_N
13	CONFIG1	14	CONFIG2
15	DPC0_AUXP_C	16	GND
17	DPC0_AUXN_C	18	HPD
19	RETURN	20	DPO_PWR

DC Output

Connector Number: 16

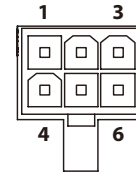

Pin	Definition	Pin	Definition
1	Voltage from Car Battery (2A)	2	12VDC Out (2A)
3	SMB_CLK(For VTK61B)	4	GND
5	GND	6	SMB_DAT(For VTK61B)

DC Input 9V-36V

Connector Number: 17



Pin	Definition
1	GND_IN
2	V_IN
3	IGNITION

COM3 (RS422/485)

Connector Number: 18

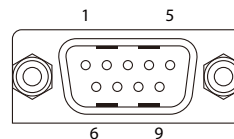

Pin	Definition	Pin	Definition
1	NC	2	RS485_-/RS422_RX-
3	RS485_+/RS422_RX+	4	NC
5	GND	6	NC
7	RS422_TX-	8	RS422_TX+
9	NC	10	NC

COM2 RS-232 (RI/12V Selectable)

Connector Number: 19

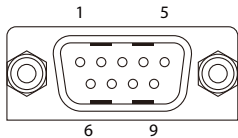

Pin	Definition	Pin	Definition
1	DCD_2	2	RXD_2
3	TXD_2	4	DTR_2
5	GND	6	DSR_2
7	RTS_2	8	CTS_2
9	RI/PW	10	NC

COM1 RS-232 (RI/12V Selectable)

Connector Number: 20

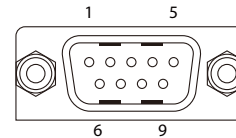

Pin	Definition	Pin	Definition
1	DCD_1	2	RXD_1
3	TXD_1	4	DTR_1
5	GND	6	DSR_1
7	RTS_1	8	CTS_1
9	RI/PW	10	NC

MCU-DIO

Connector Number: 21

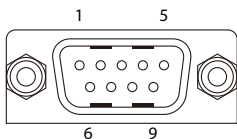

Pin	Definition	Pin	Definition
1	NC	2	NC
3	MCU-DI1	4	MCU-DI2
5	GND	6	NC
7	NC	8	MCU-DO1
9	MCU-DO2		

Chapter 3: Jumpers and Switches

This chapter describes how to set the jumpers on the VTC 6210 motherboard.

Before You Begin

- Ensure you have a stable, clean working environment. Dust and dirt can get into components and cause a malfunction. Use containers to keep small components separated.
- Adequate lighting and proper tools can prevent you from accidentally damaging the internal components. Most of the procedures that follow require only a few simple tools, including the following:
 - A Philips screwdriver
 - A flat-tipped screwdriver
 - A set of jewelers screwdrivers
 - A grounding strap
 - An anti-static pad
- Using your fingers can disconnect most of the connections. It is recommended that you do not use needle-nosed pliers to disconnect connections as these can damage the soft metal or plastic parts of the connectors.
- Before working on internal components, make sure that the power is off. Ground yourself before touching any internal components, by touching a metal object. Static electricity can damage many of the electronic components. Humid environment tend to have less static electricity than dry environments. A grounding strap is warranted whenever danger of static electricity exists.

Precautions

Computer components and electronic circuit boards can be damaged by discharges of static electricity. Working on the computers that are still connected to a power supply can be extremely dangerous.

Follow the guidelines below to avoid damage to your computer or yourself:

- Always disconnect the unit from the power outlet whenever you are working inside the case.
- If possible, wear a grounded wrist strap when you are working inside the computer case. Alternatively, discharge any static electricity by touching the bare metal chassis of the unit case, or the bare metal body of any other grounded appliance.
- Hold electronic circuit boards by the edges only. Do not touch the components on the board unless it is necessary to do so. Don't flex or stress the circuit board.
- Leave all components inside the static-proof packaging that they shipped with until they are ready for installation.
- Use correct screws and do not over tighten screws.

Jumper Settings

A jumper is the simplest kind of electric switch. It consists of two metal pins and a cap. When setting the jumpers, ensure that the jumper caps are placed on the correct pins. When the jumper cap is placed on both pins, the jumper is short. If you remove the jumper cap, or place the jumper cap on just one pin, the jumper is open.

Refer to the illustrations below for examples of what the 2-pin and 3-pin jumpers look like when they are short (on) and open (off).

Two-Pin Jumpers: Open (Left) and Short (Right)

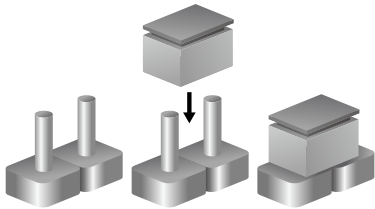

Three-Pin Jumpers: Pins 1 and 2 are Short

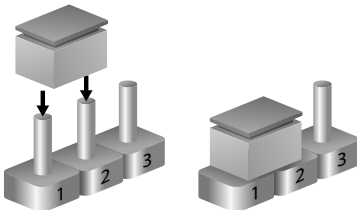

VTC 6210 Connector Specification & Jumper Setting

VTC 6210 carrier board placement

The figure below is the carrier board used in the VTC 6210 system. It shows the locations of the jumpers and connectors.

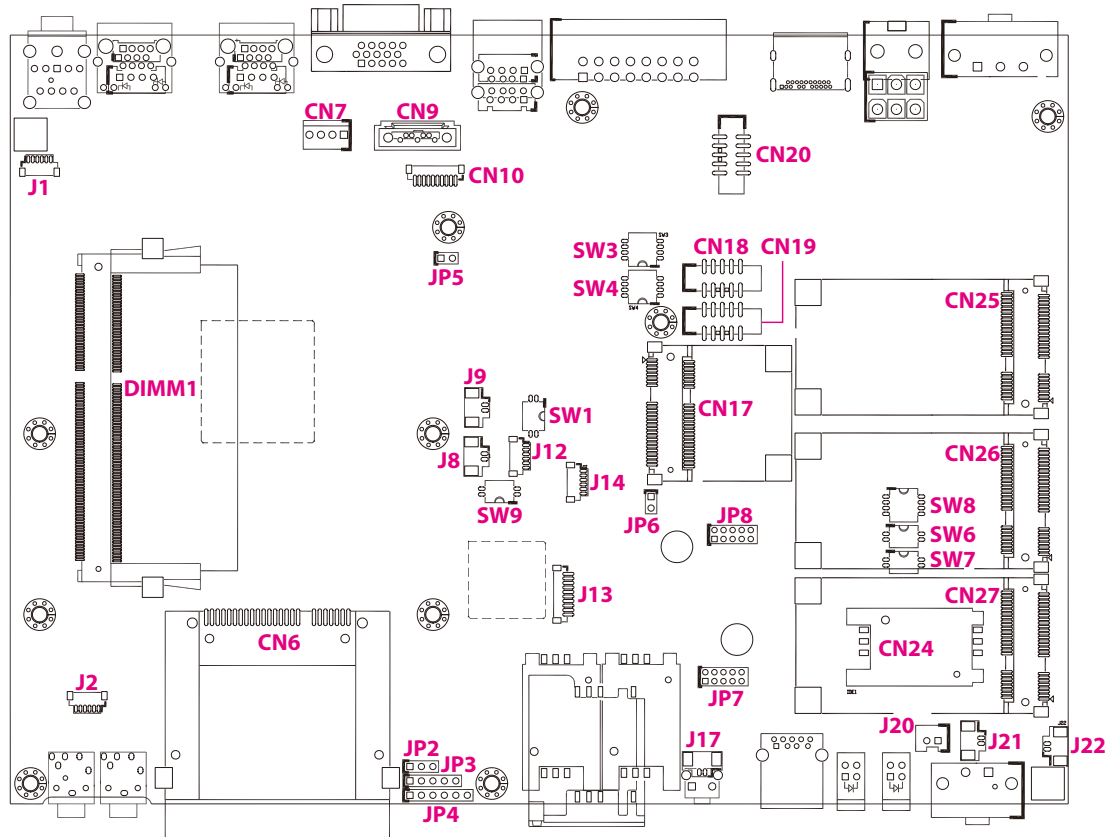

DIP Switch Settings

RTC Clear Selection

Connector location: SW1

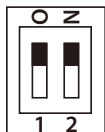

	Normal(*)	Clear ME	Clear CMOS
SW1.1	OFF	OFF	ON
SW1.2	OFF	ON	OFF

(*) Default

GPIO Pull-High Setup

Connector location: SW2

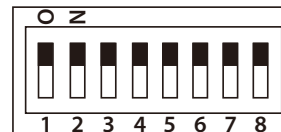

	ON	OFF
SW2.1	GPIO1 Pull-High 5V	Open
SW2.2	GPIO 2 Pull-High 5V	Open
SW2.3	GPIO 3 Pull-High 5V	Open
SW2.4	GPIO 4 Pull-High 5V	Open
SW2.5	GPIO 5 Pull-High 5V	Open
SW2.6	GPIO 6 Pull-High 5V	Open
SW2.7	GPIO 7 Pull-High 5V	Open
SW2.8	GPIO 8 Pull-High 5V	Open

COM1 RI/12VDC Selection

Connector location: SW3

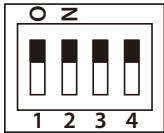

	ON	OFF
SW3.1	12V	NC
SW3.2 (Keep it at OFF)	NC	NC
SW3.3(*)	Ring	NC
SW3.4	NC	NC

(*) Default

COM2 RI/12VDC Selection

Connector location: SW4

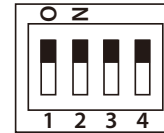

	ON	OFF
SW4.1	12V	NC
SW4.2 (Keep it at OFF)	NC	NC
SW4.3(*)	Ring	NC
SW4.4	NC	NC

(*) Default

MiniCard (CN26) Power Selection

Connector location: SW6

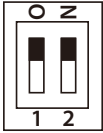

	3.3V(*)	3.6V
SW6.1	OFF	ON
SW6.2	OFF	ON

(*) Default

WWAN Module Selection Table (For Wake-Up & Voice Functions on Mini-PCIe CN26)

Connector location: SW8

If SMS/Ring Wake Up function or/and Voice Function is/are not needed, the setting on SW8 can be ignored.

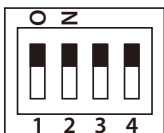

WWAN Module	SW8.1	SW8.2	SW8.3	SW8.4
Sierra MC7700	OFF	OFF	ON	OFF
Sierra MC7710	OFF	OFF	ON	OFF
Sierra MC7750	OFF	OFF	ON	OFF
Sierra MC8805	OFF	OFF	ON	OFF
HUAWEI EM820W	OFF	OFF	ON	OFF
Sierra MC7355	OFF	OFF	ON	OFF
Telit HE910	OFF	OFF	ON	OFF
CM8000(*)	ON	OFF	OFF	ON
Sierra MC8090/MC8092	ON	OFF	OFF	OFF
Sierra MC9090	OFF	OFF	ON	OFF

(*) Default

(Digital voice is selectable in BIOS)

Input Voltage Setup Selection

Connector location: SW9

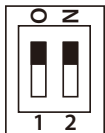

	12V	24V	9V~36V (* all can start
SW9.1	OFF	OFF	ON
SW9.2	OFF	ON	Don't Care

(*) Default

Connectors

RTC Battery Connector

Connector size: 1 x 2 = 2-pin header (1.25mm)

Connector location: J9

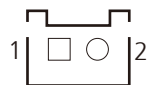

Pin	Definition
1	GND
2	RTC_BAT

Debug 80 Port Connector

Connector size: 1 x 10 = 10-pin header (1.0mm)

Connector location: J13



Pin	Definition	Pin	Definition
1	GND	2	PCIRST#
3	33M_CLK	4	LPC_FRAME#
5	LPC_AD3	6	LPC_AD2
7	LPC_AD1	8	LPC_ADO
9	VCC3	10	VCC3

COM Port Connector (COM1 RS-232)

Connector size: 2 x 5 = 10-pin header (2.00mm)

Connector location: CN18



Pin	Definition	Pin	Definition
1	DCD_1	2	RXD_1
3	TXD_1	4	DTR_1
5	GND	6	DSR_1
7	RTS_1	8	CTS_1
9	RI/PW	10	NC

COM Port Connector (COM2 RS-232)

Connector size: 2 x 5 = 10-pin header (2.00mm)

Connector location: CN19



Pin	Definition	Pin	Definition
1	DCD_2	2	RXD_2
3	TXD_2	4	DTR_2
5	GND	6	DSR_2
7	RTS_2	8	CTS_2
9	RI/PW	10	NC

COM Port Connector (COM3 - RS422/485)

Connector size: 2 x 5 = 10-pin header (2.00mm)

Connector location: CN20

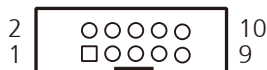

Pin	Definition	Pin	Definition
1	NC	2	RS485_-/RS422_RX-
3	RS485_+/RS422_RX+	4	NC
5	GND	6	NC
7	RS422_TX-	8	RS422_TX+
9	NC	10	NC

MCU-DIO Connector

Connector size: 1 x 10 = 10-pin header (1.0mm)

Connector location: CN10



Pin	Definition	Pin	Definition
1	GND	2	SIO_RTS_1
3	SIO_TXD_1	4	SIO_CTS_1
5	SIO_RXD_1	6	GND
7	SIO_CTS_0	8	SIO_RXD_0
9	SIO_RTS_0	10	SIO_TXD_0

Reset Button (Reserved)

Connector size: 1 x 2 = 2-pin header (1.25mm)

Connector location: J17

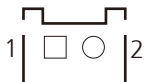

Pin	Definition
1-2 Open	NORMAL
1-2 Short	RESET#

Power Button Connector (Reserved)

Connector size: 1 x 2 = 2-pin header (2.5mm)

Connector location: J20



Pin	Definition
1	GND
2	PB

SATA HDD Connector

Connector size: CN7, 1 x 4 = 4-pin header (2.54mm)

CN9 1 x 7 = 7-pin header (1.27mm)

Connector location: CN7 & CN9

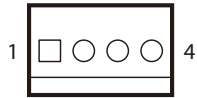

CN7

Pin	Definition	Pin	Definition
1	VCC12	2	GND
3	GND	4	VCC5

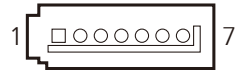

CN9

Pin	Definition	Pin	Definition
1	GND	2	SATA_TXP0
3	SATA_TXN0	4	GND
5	SATA_RXN0	6	SATA_RXP0
7	GND		

OBDII Module Connector

Connector size: 2 x 5 = 10-pin header (2.0mm)

Connector location: JP8 & JP7

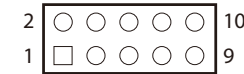

JP8

Pin	Definition	Pin	Definition
1	CAN_M_H	2	C1708_1_H
3	CAN_M_L	4	C1708_1_L
5	GND	6	GND
7	NC	8	NC
9	NC	10	NC

JP7

Pin	Definition	Pin	Definition
1	TXD	2	RXD
3	CAN_DI1	4	CAN_DO1
5	GND	6	GND
7	NC	8	NC
9	CAN_M_VCC5	10	NC

Debug Port

Connector size: 1 x 3 = 3-pin header (2.54mm)

Connector location: JP2



Pin	Definition
1	TX
2	RX
3	GND

GAL Download Port

Connector size: 1 x 6 = 6-pin header (2.54mm)

Connector location: JP4



Pin	Definition	Pin	Definition
1	VCC3	2	GND
3	TCK	4	TDO
5	TDI	6	TMS

GPS Connector

Connector size: 1 x 6 = 6-pin header (1.0mm)

Connector location: J12

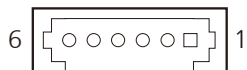

Pin	Definition	Pin	Definition
1	GPS_BAT	2	GPS_LED#
3	GPS_TX	4	GPS_RX
5	GND	6	VCC3_GPS

Internal WWAN SIM Card Socket (SIM 3) For CN27

Connector location: CN24

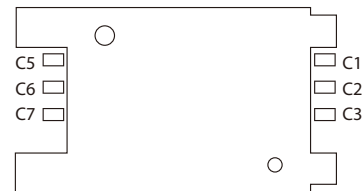

Pin	Definition	Pin	Definition
C1	SIM PWR	C5	GND
C2	SIM RST	C6	NC
C3	SIM CLK	C7	SIM DAT

MCU Download Port

Connector size: 1 x 5 = 5-pin header (2.54mm)

Connector location: JP3



Pin	Definition	Pin	Definition
1	V3.3ALW	2	C2D
3	MRST	4	C2CK
5	GND		

Mini-PCle (USB + PCIe)

Connector location: CN17

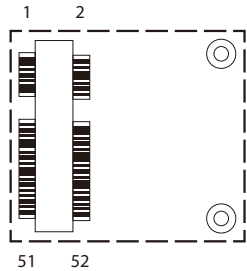

Pin	Definition	Pin	Definition
1	WAKE#	2	+V3.3A_MINI1
3	NC	4	GND
5	NC	6	+V1.5S_MINI1
7	CLK_REQ#	8	NC
9	GND	10	NC
11	PCIE_CLK#	12	NC
13	PCIE_CLK	14	NC
15	GND	16	NC
17	NC	18	GND
19	NC	20	WLAN_DIS#
21	GND	22	RESET#
23	PCIE_RX_N	24	+V3.3A_MINI1
25	PCIE_RX_P	26	GND

Pin	Definition	Pin	Definition
27	GND	28	+V1.5S_MINI1
29	GND	30	SMBCLK
31	PCIE_TX_N	32	SMBDAT
33	PCIE_TX_P	34	GND
35	GND	36	USB-
37	GND	38	USB+
39	+V3.3A_MINI1	40	GND
41	+V3.3A_MINI1	42	NC
43	GND	44	WLAN_LED#
45	NC	46	NC
47	NC	48	+V1.5S_MINI1
49	NC	50	GND
51	BT_EN	52	+V3.3A_MINI1

Mini-PCle (USB + PCIe)

Connector location: CN25

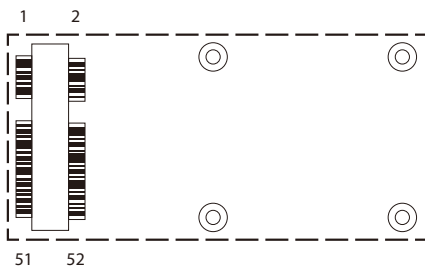

Pin	Definition	Pin	Definition
1	WAKE#	2	+V3.3_MINI_3
3	NC	4	GND
5	NC	6	+V1.5S_MINI_3
7	CLKREQ	8	NC
9	GND	10	NC
11	REFCLK-	12	NC
13	REFCLK+	14	NC
15	GND	16	NC
17	NC	18	GND
19	NC	20	MINICARD3_DIS#
21	GND	22	WLAN_RESET#
23	PCIE_RX_N	24	+V3.3_MINI_3
25	PCIE_RX_P	26	GND

Pin	Definition	Pin	Definition
27	GND	28	+V1.5S_MINI_3
29	GND	30	SMBCLK
31	PCIE_TX_N	32	SMBDAT
33	PCIE_TX_P	34	GND
35	GND	36	USB_D-
37	GND	38	USB_D+
39	+V3.3_MINI_3	40	GND
41	+V3.3_MINI_3	42	WWAN_LED#
43	GND	44	NC
45	NC	46	NC
47	NC	48	+V1.5S_MINI_3
49	NC	50	GND
51	CTRL0	52	+V3.3_MINI_3

Mini-PCIe (USB)

Connector location: CN26

SIM Socket: SIM 1 (default)

SIM Socket: SIM 2

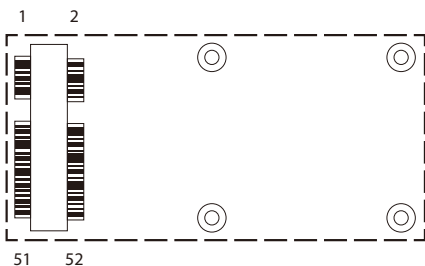

Pin	Definition	Pin	Definition
1	MINI_MIC_P	2	+V3.3A_MINI_4
3	MINI_MIC_N	4	GND
5	MINI_SPK_PRR	6	NC
7	U_GND	8	UIM_PWR2
9	GND	10	UIM_DAT2
11	VCC_MSM26_DIG	12	UIM_CLK2
13	NC	14	UIM_RST2
15	GND	16	NC
17	NC	18	GND
19	NC	20	3.5G_DIS#
21	GND	22	3.5G_RST#
23	NC	24	+V3.3A_MINI_4
25	NC	26	GND

Pin	Definition	Pin	Definition
27	GND	28	NC
29	GND	30	NC
31	NC	32	SMS_RI_3.5G_R
33	UMTS_RESET#_R	34	GND
35	GND	36	USB-
37	GND	38	USB+
39	+V3.3A_MINI_4	40	GND
41	+V3.3A_MINI_4	42	3.5G_LED#_R
43	GND	44	NC
45	PCM_CLK	46	NC
47	PCM_RX	48	NC
49	PCM_TX	50	GND
51	PCM_SYNC	52	+V3.3A_MINI_4

Mini-PCIe (USB)

Connector location: CN27

SIM Socket: SIM 2 (default)

SIM Socket: SIM 3

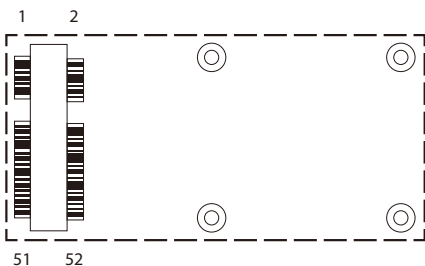

Pin	Definition	Pin	Definition
1	NC	2	+V3.3A_MINI_2
3	NC	4	GND
5	NC	6	+V1.5S_MINI_2
7	NC	8	UIM2_PWR2_MINI
9	GND	10	UIM2_DAT2_MINI
11	VCC_MSM26_DIG	12	UIM2_CLK2_MINI
13	NC	14	UIM2_RST2_MINI
15	GND	16	NC
17	NC	18	GND
19	NC	20	3.5G_DIS#
21	GND	22	3.5G_RST#
23	NC	24	+V3.3A_MINI_2
25	NC	26	GND

Pin	Definition	Pin	Definition
27	GND	28	+V1.5S_MINI_2
29	GND	30	NC
31	NC	32	NC
33	UMTS_RESET#_R	34	GND
35	GND	36	USB-
37	GND	38	USB+
39	+V3.3A_MINI_2	40	GND
41	+V3.3A_MINI_2	42	NC
43	GND	44	PCIE2_LED
45	NC	46	NC
47	NC	48	+V1.5S_MINI_2
49	NC	50	GND
51	NC	52	+V3.3A_MINI_2

Chapter 4: System Setup

Removing the Chassis Cover



Prior to removing the chassis cover, make sure the unit's power is off and disconnected from the power sources to prevent electric shock or system damage.

1. The screws on the front and the rear are used to secure the cover to the chassis. Remove these screws and put them in a safe place for later use.

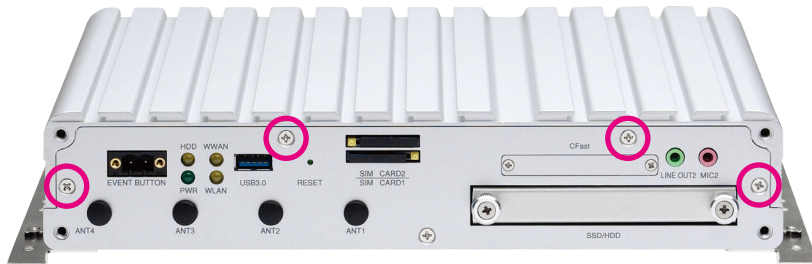

Front View

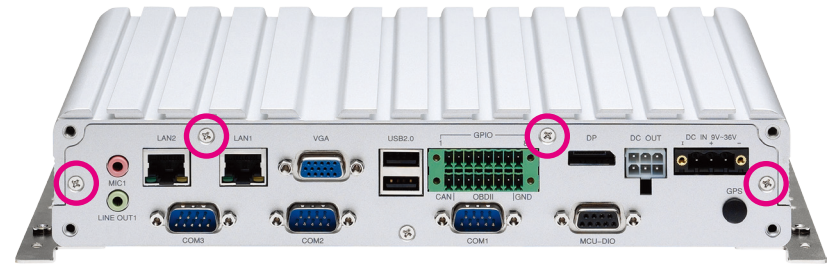

Rear View

Installing a SSD/HDD Drive

1. Loosen the thumb screws on the SSD/HDD drive bay and slide the drive bay out.

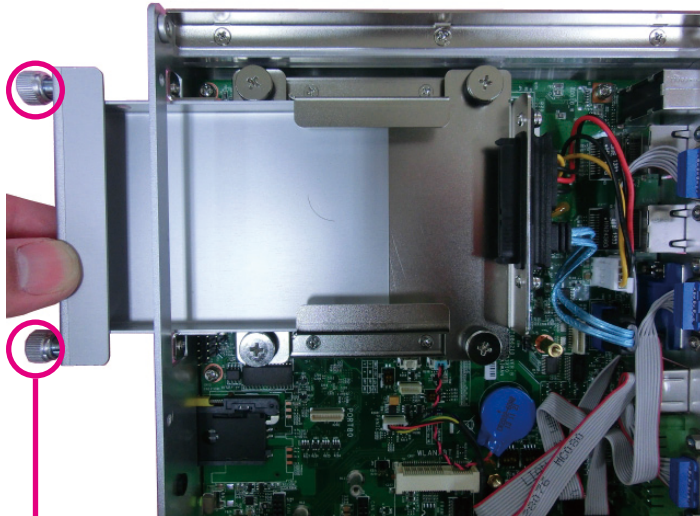

Thumb screws

2. Insert the hard drive into the drive bay with the SATA data and power connector facing towards the end. Align the hard drive's mounting holes with the mounting holes on the drive bay, and use the provided screws to secure the hard drive in place.

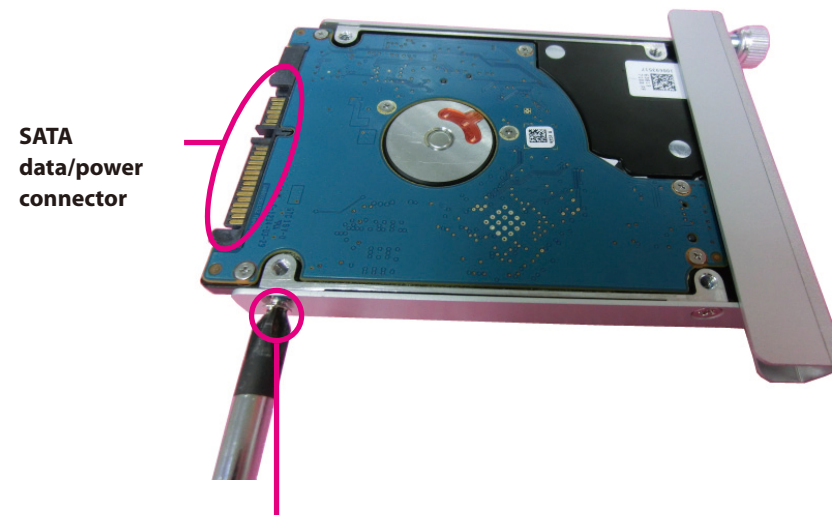

SATA data/power connector

Mounting screws

3. Insert the drive bay back in the SSD/HDD slot and tighten the thumb screws to secure it in place.

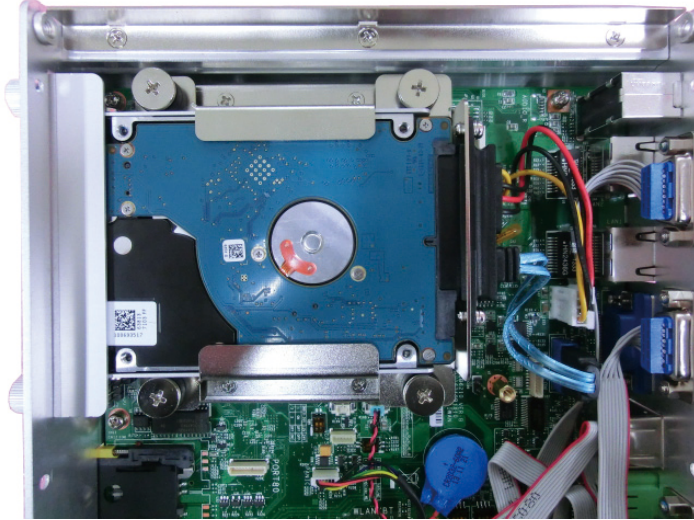

Installing a WLAN Module (Half Mini-PCIe)

1. Locate the WLAN Mini PCI Express slot (CN17). Insert the module into the Mini PCI Express slot at a 45 degrees angle until the gold-plated connector on the edge of the module completely disappears inside the slot. Then fasten screws into the mounting holes to secure the module.

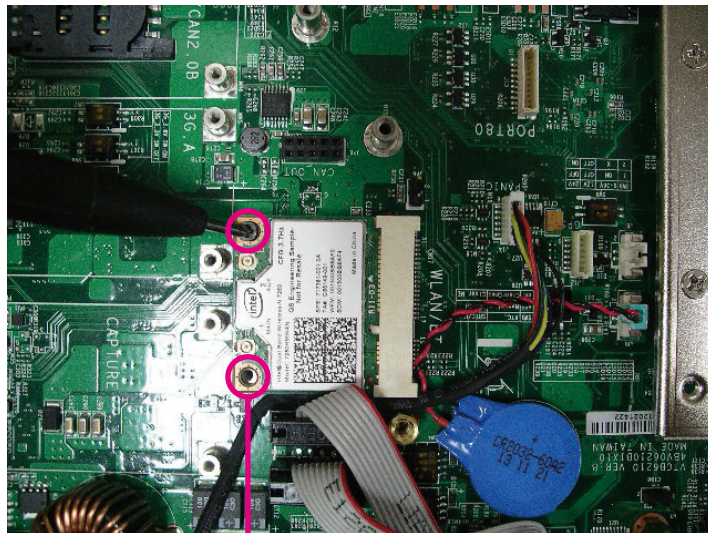

Mounting screws

Installing a WWAN Module

1. Locate the WWAN Mini PCI Express slot (CN26 & CN27). Insert the module into the Mini PCI Express slot at a 45 degrees angle until the gold-plated connector on the edge of the module completely disappears inside the slot. Then fasten screws into the mounting holes to secure the module.



Mounting screws

Installing a SO-DIMM

1. Push the ejector tabs which are at the ends of the socket outward. Then insert the module into the socket at an approximately 30 degrees angle. Apply firm even pressure to each end of the module until it slips down into the socket. The contact fingers on the edge of the module will almost completely disappear inside the socket.

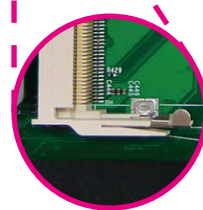
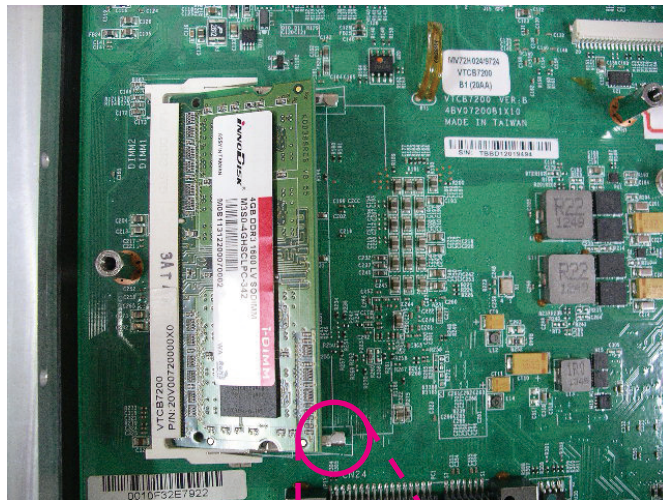

Ejector tab

Installing a OBDII Module

1. Locate the OBDII connectors (JP7 and JP8).

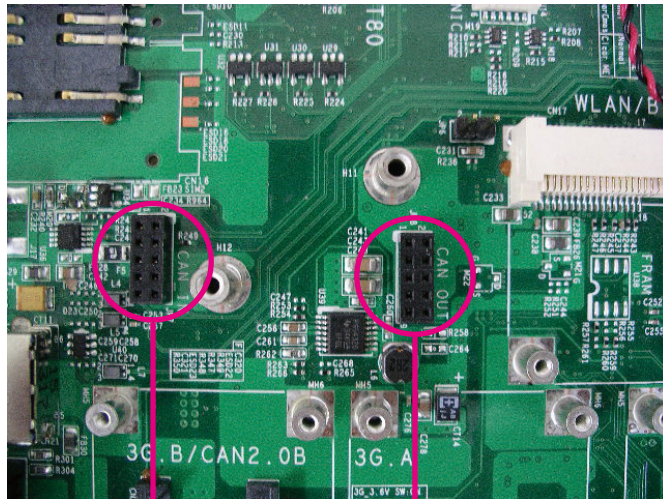

JP7

JP8

2. Connect the OBDII module to JP4 and JP3 and secure the OBDII module with screws.

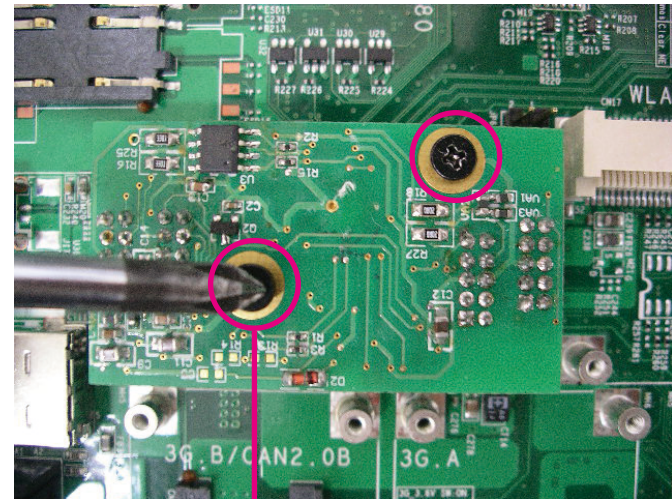

Mounting
screws

Appendix A: Software Demo Utility for I/O Ports of Function Control

NEXCOM's software demo utility enables users to test and control different I/O port functions on the VTC 6210. This document shows how to use the utility.

There are also source code files of the utility in the CD. Users can refer to the source codes to develop their applications.

Menu Screen

The screenshot displays the VTC6210_IO_Utility application window. The interface is organized into several functional panels:

- Status:** Includes 'Ignition Status' and 'Battery Status' indicators.
- GPIO Setting:** A grid for configuring GPIO pins 1 through 8, with options for 'Low' and 'Set/Read/Select'.
- MCU GPIO Setting:** Similar to the main GPIO setting, but for MCU-specific pins.
- WDT Setting:** Configures Watchdog Timer (WDT) settings, including 'Disable', '1 sec', and a 'Clear Timer' button.
- Power On Delay Time:** Sets the delay time for power-on, with options for 'Disable', '10 sec', and a 'Set' button.
- Power Off Delay Time:** Sets the delay time for power-off, with options for 'Disable', '20 sec', and a 'Set' button.
- Wakeup Function:** Configures '3G' and 'RTC' wakeup functions with 'Set' buttons.
- RS422/RS485:** Configures the RS485 mode, with a dropdown set to 'RS-485' and a 'Set' button.
- CAN Bus Setting:** Includes 'OBDII Module Reset' and 'OBDII Module Power Reset' options, each with a 'Set' button.
- Interface Power:** Configures power settings for 'USB No.13', 'USB No.3', 'GPS', and 'Mini-PCiE' (CN17, CN25), each with a 'Set' button.
- Other Settings:** Includes 'Input Voltage' (9V~36V), 'Output Power' (External +12V), 'On Board CAN 2.0B Data Link Status', and 'WLAN (Half Card)'.

1.1 Status

1.1.1 Ignition Status

Press the button of Ignition Status, the signal of ignition will be shown.

ON Signal of ignition is high.

OFF Signal of ignition is low.

1.1.2 Battery Status

Press the button of Battery Status, the status of battery voltage will be shown.

Low voltage Car battery is at low voltage.

OK Car battery is not at low voltage.

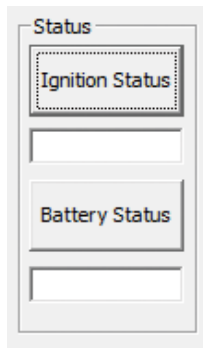

1.2 Input Voltage

Shows the setting of input voltage in SW8 DIP switch.

If the setting is 12V:

12V is shown

If the setting is 24V:

24V is shown

If the setting is 9V~36V:

9V~36V is shown

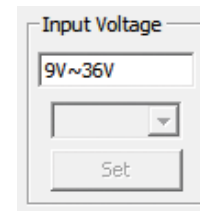

1.3 Output Power

1.3.1 External +12V

Enables or disables the output of 12VDC.

1.3.2 Bypass Car Battery Power

Enables or Disables the output of Car Battery Power.

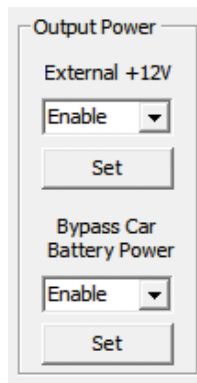

Output Power

External +12V

Enable ▼

Set

Bypass Car Battery Power

Enable ▼

Set

1.4 GPIO Setting

1.4.1 GPIO Select

Defines GPIO port as GPO or GPI.

1.4.2 GPO Set

Selects the GPO ports and makes the output low or high.

1.4.3 GPI Read

Reads the status of GPI.

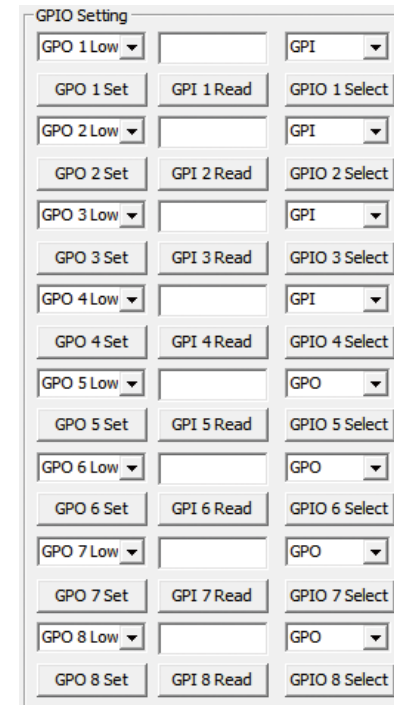

GPIO Setting

GPO 1 Low ▼		GPI ▼	GPI 1 Select
GPO 1 Set	GPI 1 Read		
GPO 2 Low ▼		GPI ▼	GPI 2 Select
GPO 2 Set	GPI 2 Read		
GPO 3 Low ▼		GPI ▼	GPI 3 Select
GPO 3 Set	GPI 3 Read		
GPO 4 Low ▼		GPI ▼	GPI 4 Select
GPO 4 Set	GPI 4 Read		
GPO 5 Low ▼		GPO ▼	GPI 5 Select
GPO 5 Set	GPI 5 Read		
GPO 6 Low ▼		GPO ▼	GPI 6 Select
GPO 6 Set	GPI 6 Read		
GPO 7 Low ▼		GPO ▼	GPI 7 Select
GPO 7 Set	GPI 7 Read		
GPO 8 Low ▼		GPO ▼	GPI 8 Select
GPO 8 Set	GPI 8 Read		

1.5 MCU GPIO Setting

1.5.1 MCU GPO Set

Selects MCU GPO ports and makes the output low or high.

1.5.2 MCU GPI Status

Shows the status of the MCU GPI.



1.5.3 Event Button Read

Shows the status of Event Button.

Normal: 0 (default)

Triggered: 1

1.5.4 Event Record Clear

Clears the event record in MCU.

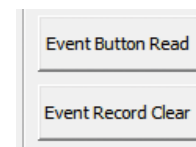

1.6 WDT Setting

Enables or disables the WDT function. There are 9 selections of time. The timer of WDT can also be cleared by Clear Timer button.



1.7 WWAN Module

1.7.1 Mini-PCIe CN27

Selects SIM2 or SIM3 card.

1.7.2 Mini-PCIe CN26

Selects SIM1 or SIM2 card.

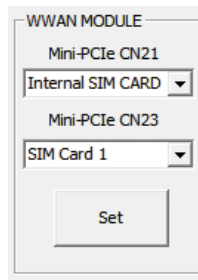

WWAN MODULE

Mini-PCIe CN21
Internal SIM CARD

Mini-PCIe CN23
SIM Card 1

Set

1.8 Selection of RS-422 or RS-485 for COM3

Enables or disables the power on delay time function. There are 8 selections of delay time.

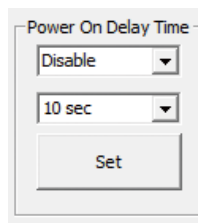

Power On Delay Time

Disable

10 sec

Set

1.9 Power Off Delay Time

Enables or disables the power off delay time function. There are 8 selections of delay time.

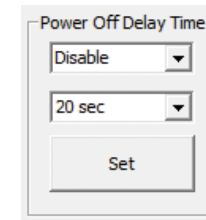

Power Off Delay Time

Disable

20 sec

Set

1.10 Wake Up Function

1.10.1 WWAN

Enables or disables the standby power to Mini-PCle socket (CN23) for wake-up function.

** The wake-up function is triggered by external RING or SMS.

1.10.2 RTC

Enables or disables the RTC wake up function. The timer setting of RTC is located in BIOS setting.

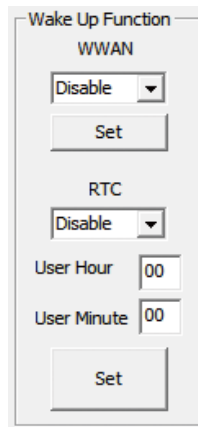

1.11 CAN Bus Setting

1.11.1 OBDII Module Reset

Reset OBDII module.

1.11.2 OBDII Module Power Reset

Reset the power of OBDII module.

1.11.3 On Board CAN2.0B Data Link Status

Reads the connection status of on board CAN2.0B

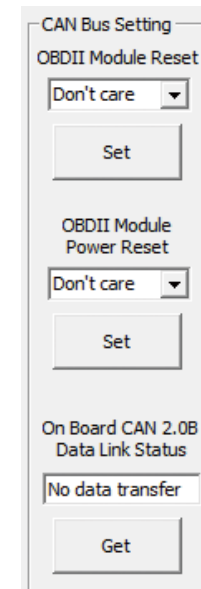

1.12 Interface Power

1.12.1 USB No.13

Enables or disables the power to USB ports (No.13) on rear panel.

***In order to make all input devices (such as mouse and keyboard) work correctly, please do not disable USB No. 13 and No.3 at the same time.**

1.12.2 USB No.3

Enables or disables the power to USB ports (No.3) on front panel.

1.12.3 GPS

Enables or disables the power to GPS module.

Interface Power

USB No. 13
Enable ▾
Set

USB No. 3
Enable ▾
Set

GPS
Enable ▾
Set

1.13 Mini-PCIe Power

1.13.1 CN17

Enables or disables the power to USB port on CN17.

1.13.2 CN25

Enables or disables the power to USB port on CN25.

Mini-PCIe

CN17
Enable ▾
Set

CN25
Enable ▾
Set

Appendix B: GPS Feature

uBlox-NEO M8 Overview

The NEO-M8 series of standalone concurrent GNSS modules is built on the exceptional performance of the u-blox M8 GNSS (GPS, GLONASS, Galileo, BeiDou, QZSS and SBAS) engine in the industry proven NEO form factor.

The NEO-M8 series provides high sensitivity and minimal acquisition times while maintaining low system power. The NEO-M8M is optimized for cost sensitive applications, while NEO-M8N and NEO-M8Q provide best performance and easier RF integration. The NEO form factor allows easy migration from previous NEO generations. Sophisticated RF-architecture and interference suppression ensure maximum performance even in GNSS-hostile environments.

The NEO-M8 combines a high level of robustness and integration capability with flexible connectivity options. The future-proof NEO-M8N includes an internal Flash that allows simple firmware upgrades for supporting additional GNSS systems. This makes NEO-M8 perfectly suited to industrial and automotive applications.

The DDC (I2C compliant) interface provides connectivity and enables synergies with most u-blox cellular modules. For RF optimization the NEO-M8N/Q features an additional front-end LNA for easier antenna integration and a front-end SAW filter for increased jamming immunity.

u-blox M8 modules use GNSS chips qualified according to AEC-Q100, are manufactured in ISO/TS 16949 certified sites, and fully tested on a system level. Qualification tests are performed as stipulated in the ISO16750 standard: "Road vehicles – Environmental conditions and testing for electrical and electronic equipment".

Technical Specifications

COM Port for GPS: COM 4

Baud Rate: 9600

Features

Receiver type	72-channel u-blox M8 engine GPS/QZSS L1 C/A, GLONASS L10F, BeiDou B1 SBAS L1 C/A: WAAS, EGNOS, MSAS Galileo-ready E1B/C (NEO-M8N)		
Nav. update rate¹	Single GNSS: up to 18 Hz Concurrent GNSS: up to 10 Hz		
Position accuracy	2.0 m CEP		
		NEO-M8N/Q	NEO-M8M
Acquisition	Cold starts:	27 s	27 s
	Aided starts:	2 s	4 s
	Reacquisition:	1 s	1 s
Sensitivity	Tracking & Nav:	-167 dBm	-164 dBm
	Cold starts:	-148 dBm	-147 dBm
	Hot starts:	-156 dBm	-156 dBm
Assistance	AssistNow GNSS Online AssistNow GNSS Offline (up to 35 days) AssistNow Autonomous (up to 6 days) OMA SUPL & 3GPP compliant		
Oscillator	TCXO (NEO-M8N/Q), Crystal (NEO-M8M)		
RTC crystal	Built-in		
Noise figure	On-chip LNA (NEO-M8M). Extra LNA for lowest noise figure (NEO-M8N/Q)		

Features cont.

Anti jamming	Active CW detection and removal. Extra onboard SAW band pass filter (NEO-M8N/Q)
Memory	ROM (NEO-M8M/Q) or Flash (NEO-M8N)
Supported antennas	Active and passive
Odometer	Travelled distance
Data-logger	For position, velocity, and time (NEO-M8N)

¹ For NEO-M8M/Q

Electrical data

Supply voltage	1.65 V to 3.6 V (NEO-M8M) 2.7 V to 3.6 V (NEO-M8N/Q)
Power consumption²	23 mA @ 3.0 V (continuous) 5 mA @ 3.0 V Power Save Mode (1 Hz, GPS only)
Backup Supply	1.4 to 3.6 V

² NEO-M8M

Interfaces

Serial interfaces	1 UART 1 USBV2.0 full speed 12 Mbit/s 1 SPI (optional) 1 DDC (I ² C compliant)
Digital I/O	Configurable timepulse 1 EXTINT input for Wakeup
Timepulse	Configurable 0.25 Hz to 10 MHz
Protocols	NMEA, UBX binary, RTCM

Package

24 pin LCC (Leadless Chip Carrier): 12.2 x 16.0 x 2.4 mm, 1.6 g

Pinout

13	GND	GND	12
14	ANT_ON/Reserved	RF_IN	11
15	Reserved	GND	10
16	Reserved	VCC_RF	9
17	Reserved	RESET_N	8
NEO-M8 Top View			
18	SDA	VDD_USB	7
19	SCL	USB_DP	6
20	TxD	USB_DM	5
21	RxD	EXTINT	4
22	V_BCKP	TIMEPULSE	3
23	VCC	D_SEL	2
24	GND	Reserved	1

Environmental data, quality & reliability

Operating temp.	-40° C to 85° C
Storage temp.	-40° C to 85° C (NEO-M8N/Q) -40° C to 105° C (NEO-M8M)

RoHS compliant (lead-free)

Qualification according to ISO 16750

Manufactured and fully tested in ISO/TS 16949 certified production sites

Uses u-blox M8 chips qualified according to AEC-Q100

Appendix C: Signal Connection of DI/DO

GPIO Pinout Description

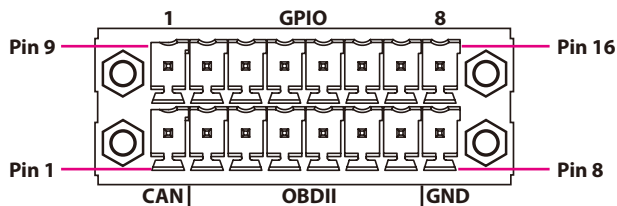

Pin	Definition
9	GPIO1 (Default: GPI1)
10	GPIO2 (Default: GPI2)
11	GPIO3 (Default: GPI3)
12	GPIO4 (Default: GPI4)
13	GPIO5 (Default: GPO1)
14	GPIO6 (Default: GPO2)
15	GPIO7 (Default: GPO3)
16	GPIO8 (Default: GPO4)

GPIO can be programmed by S/W.
Please refer to the source code in utility.

SW2 Setting

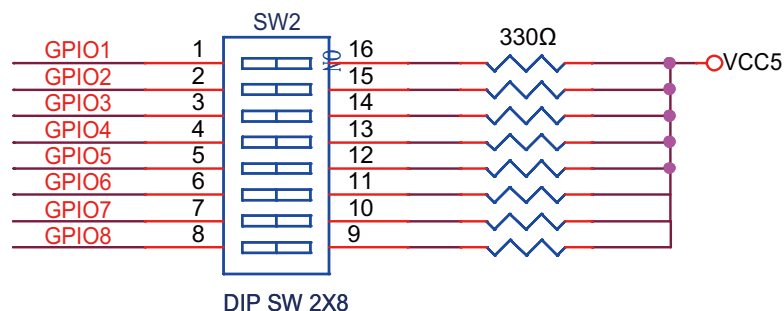

GPIO (SW2)	
On	Pull up VCC5
Off	Don't Care

Default Settings:

GPIO (SW2)	
SW2.1~SW2.8	Pull up VCC5

Digital Input

CN14 connector for GPI signal (digital signal input)
 The CN14 has 4 digital input channels by default.

Wet Contact (default)

The GPI signals have a pull up resistor to 5V internally.

The figure below shows how to connect an external output source to one of the input channel.

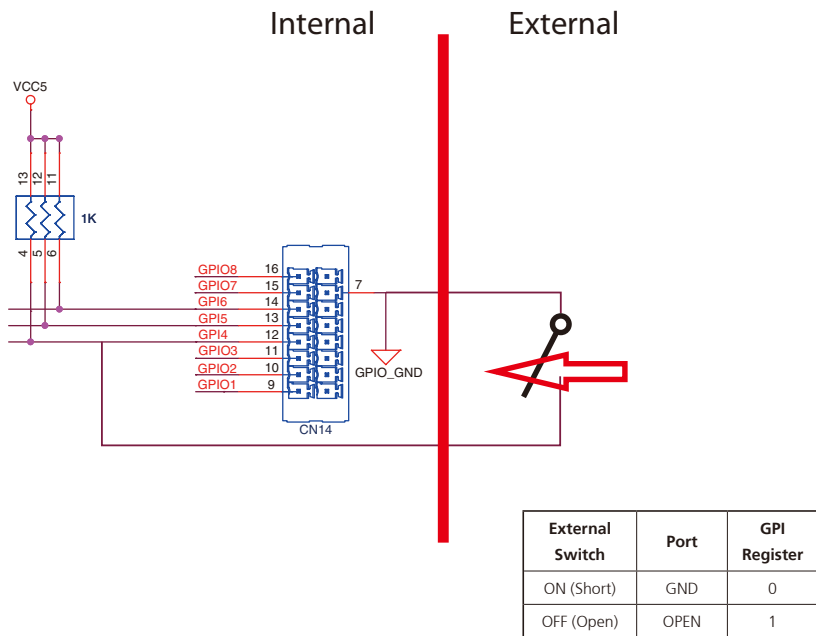

Dry Contact:

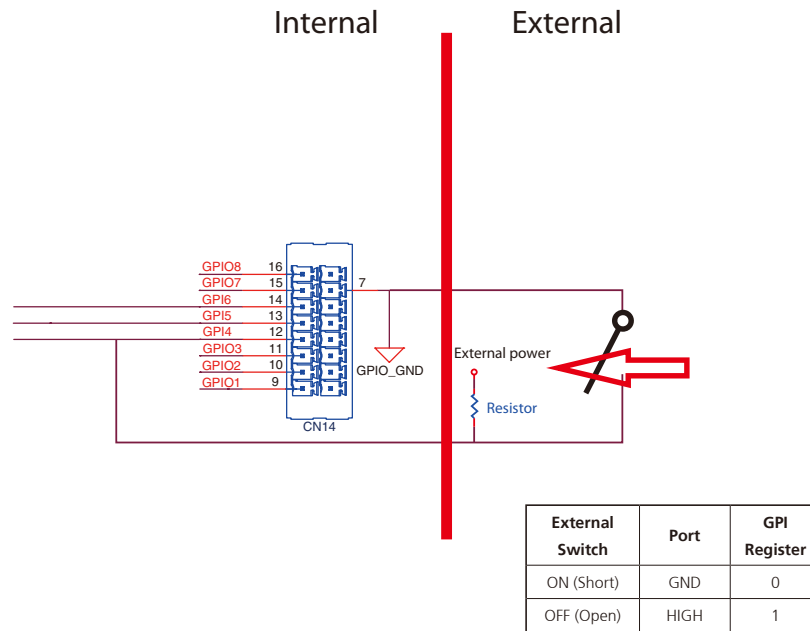

Digital Output

CN14 connector for GPO signal (digital signal output)
 The CN14 connector has 4 digital output channels by default. The signal connection of CN14 support two connected methods for output signal type.

The output signal has two states, one is low level (driven to 0V from GPO signal) other is open (high voltage is provided from external device).

Wet Contact (default)

The SW2 needs to switch to "ON" state. The GPO signal will have a pull up resistor to 5V internally when you switch "SW2" to "ON" state. The output signal has two states, one is low level (driven to 0V from GPO signal) other is high level (driven to 5V from GPO signal).

The figure below shows how to connect an external input source to one of the output channel.

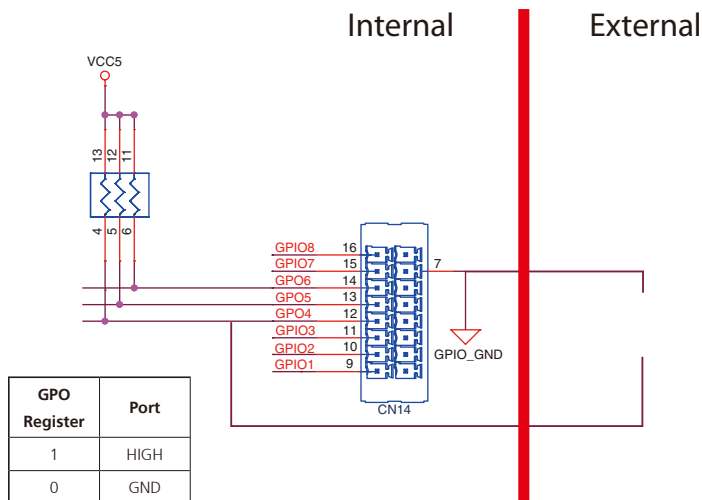

Dry Contact

Each channel can accept 3~18Vdc voltage. And it is able to drive 150mA current for low level.

The SW2 needs to switch to "OFF" state. The GPO signal will no have a pull up resistor internally when you switch "SW2" to "OFF" state.

The figure below shows how to connect an external input source to one of the output channel.

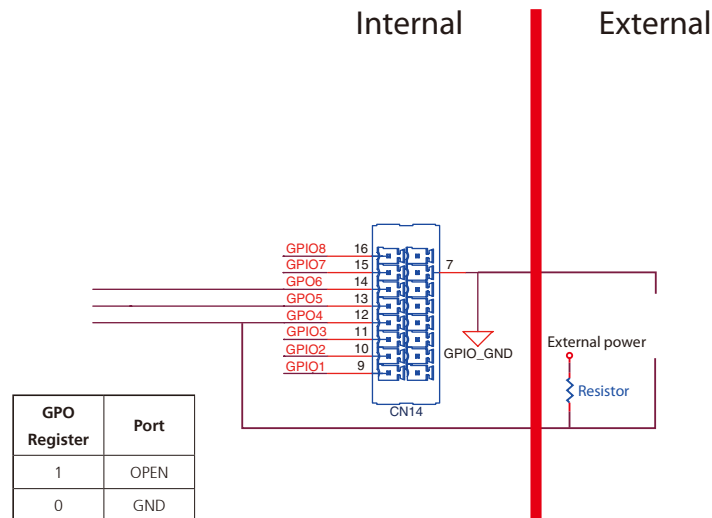

Appendix D: Signal Connection of MCU DI/DO and Event Button

MCU-DIO Pinout Description

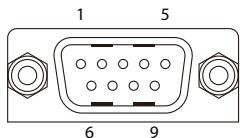

Pin	Definition	Pin	Definition
1	NC	2	NC
3	MCU-DI1	4	MCU-DI2
5	GND	6	NC
7	NC	8	MCU-DO1
9	MCU-DO2		

Digital Input

The figure below shows how to connect an external output source to one of the input channel.

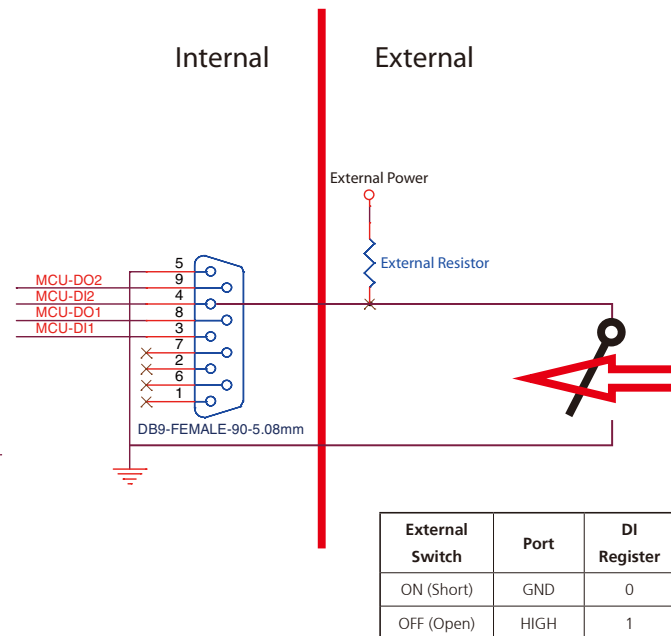

Digital Output

The figure below shows how to connect an external input source to one of the output channel.

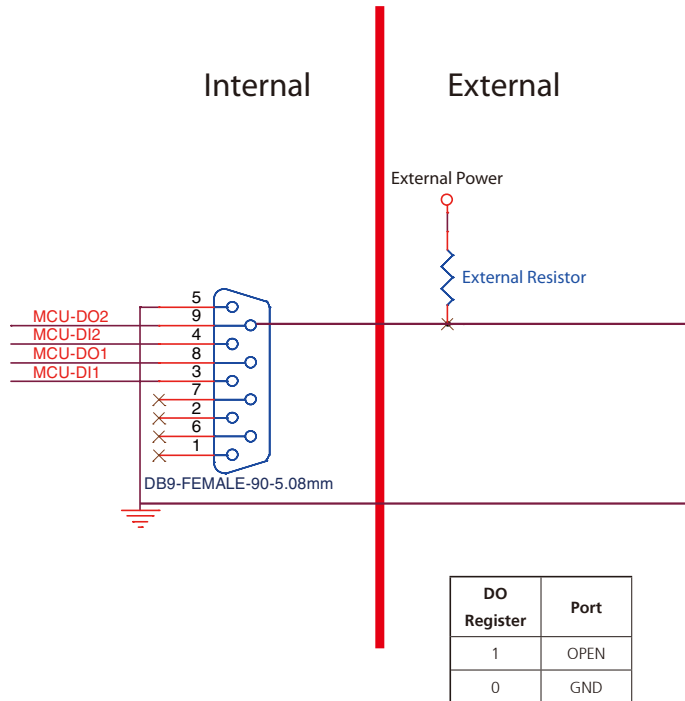

Event Button



Pin	Definition
1	Event Input
2	GND

(Status: Normal)

*When Pre-Alarm function is enabled.

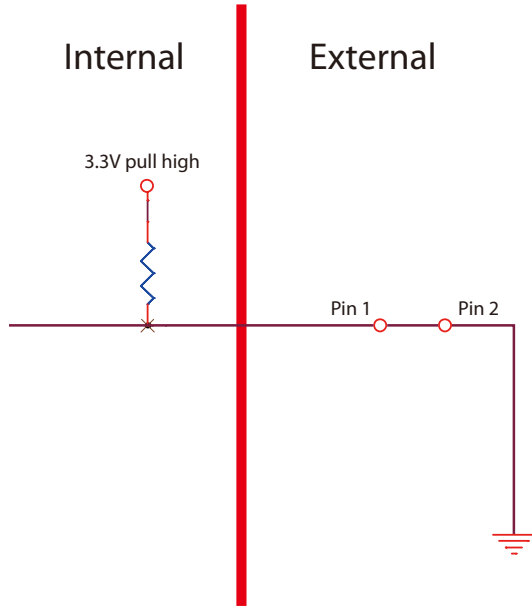

(Status: Event Occurs)

*When Pre-Alarm function is enabled.

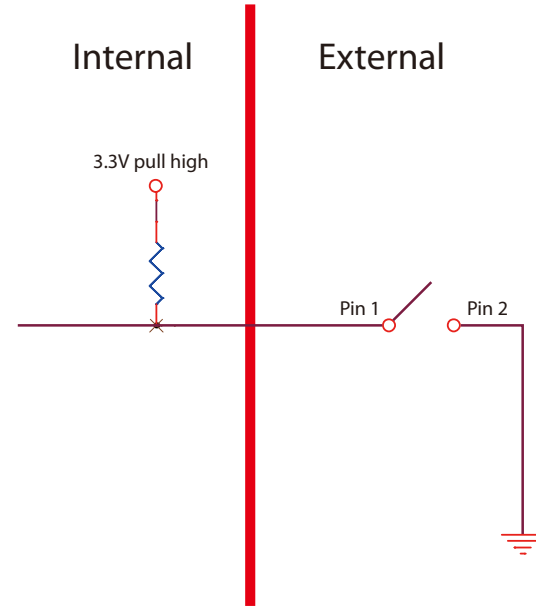

Pre-Alarm Function by Event Button, MCU-DI and MCU-DO

Pre-Alarm function allows VTC 6210 to monitor the environment and make reaction, even when VTC 6210 is turned off.

By monitoring the environment with sensors connected to Event Button and MCU-DI ports, VTC 6210 can react to certain situations. For example, events triggered by external sensors, such as temperature change, intrusion or vibration, VTC 6210 can react accordingly by turning on the siren or warning light, and power on automatically for further action against the event.

Setting up Pre-Alarm function

MCU-DI1 is used to initiate Pre-Alarm function, which is usually connected to the vehicle's Central Locking System. As such, the Pre-Alarm function on VTC 6210 will be initiated or released based on the locking and unlocking state of the Central Locking System. For instance, when the Central Locking System is initiated or released, the Pre-Alarm function on VTC 6210 will be initiated or released, respectively.

Step 1: Enable/Disable Pre-Alarm function in BIOS

Select "Enable" or "Disable" to initiate or terminate Pre-Alarm function.

Step 2: Select the trigger threshold level in BIOS

For vehicles with electric central door lock, check the corresponding trigger type (negative or positive), then connect MCU-DI1 to Central Locking System in vehicle.

Negative level: < 3.3V
Positive level: > 3.3V

If the Central Locking System is initiated (locking signal is received) by a negative signal, select "Low" in the trigger threshold level. Once the Central Locking System is released by a positive signal, the Pre-Alarm function on VTC 6210 will be released.

If Central Locking System is initiated (locking signal is received) by a positive signal, select "High" in the trigger threshold level. Once Central Locking System is released by a negative signal, the Pre-Alarm function on VTC 6210 will be released.

MCU-DI1 & MCU-DI2 (source type): 3~12VDC
MCU-DO1 & MCU-DO2 (source type): 3~18VDC

Activating Pre-Alarm function

Step 1: Setup Pre-Alarm function

Step 2: Connect Event Button to sensor (such as reed switch)

Normally, the status of Event Button is "Short". Once the status becomes "Open", Event Button will be triggered.

Step 3: Connect MCU-DI2 to sensor

Normally, the status of MCU-DI2 is "Low". Once the status becomes "High", MCU-DI2 will be triggered.

Low level: < 3.3V

High level: > 3.3V

Step 4: Connect MCU-DO1 and MCU-DO2 to external relays

Relays can be used to drive external devices (such as siren or warning light). Each MCU-DO port can wire a relay.

(Normal)

MCU-DO1 & MCU-DO2: OPEN

(Triggered)

MCU-DO1 & MCU-DO2: GND

Step 5: Flag A and Flag C will become "1" automatically

Flag A: at I/O Address -- 0x0ED8 bit4

Flag C: at I/O Address -- 0x0ED8 bit5

Deactivating Pre-Alarm function

(For Event Button)

Option 1:

If Central Locking System is initiated by negative signal:
When MCU-DI1 is "High", Pre-Alarm Function is deactivated.

If Central Locking System is initiated by positive signal:
When MCU-DI1 is "Low", Pre-Alarm Function is deactivated.

Option 2:

Whiting "1" to the Flag B, Pre-Alarm Function will be deactivated.
Flag B: at I/O Address -- 0x0ED8 bit2

Option 3:

When Ignition signal is "High", Pre-Alarm Function is deactivated.

(For MCU-DI2)

Option 1:

If Central Locking System is initiated by negative signal:
When MCU-DI1 is "High", Pre-Alarm Function is deactivated.

If Central Locking System is initiated by positive signal:
When MCU-DI1 is "Low", Pre-Alarm Function is deactivated.

Option 2:

Whiting "1" to the Flag B, Pre-Alarm Function will be deactivated.
Flag B: at I/O Address -- 0x0ED8 bit2

Option 3:

When Ignition signal is "High", Pre-Alarm Function is deactivated.

Activating Pre-Alarm Function

(For Event Button)

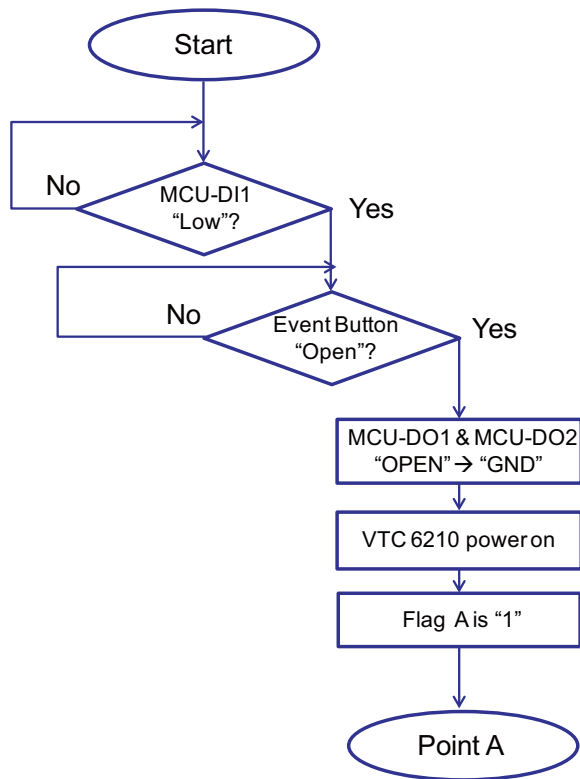

(For MCU-DI2)

Example: When Central Locking System is initiated (locking signal is received) by negative signal, select "Low" in the trigger threshold level for MCU-DI1.

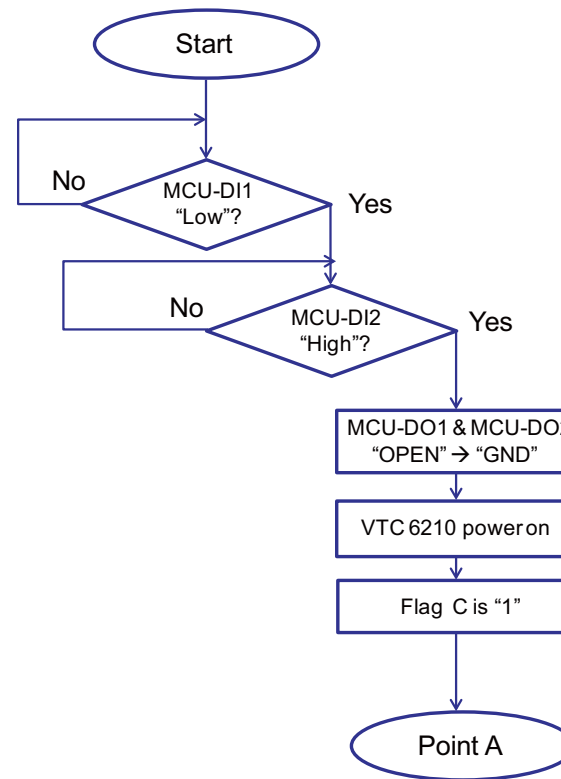

Deactivating Pre-Alarm Function

(For Event Button)

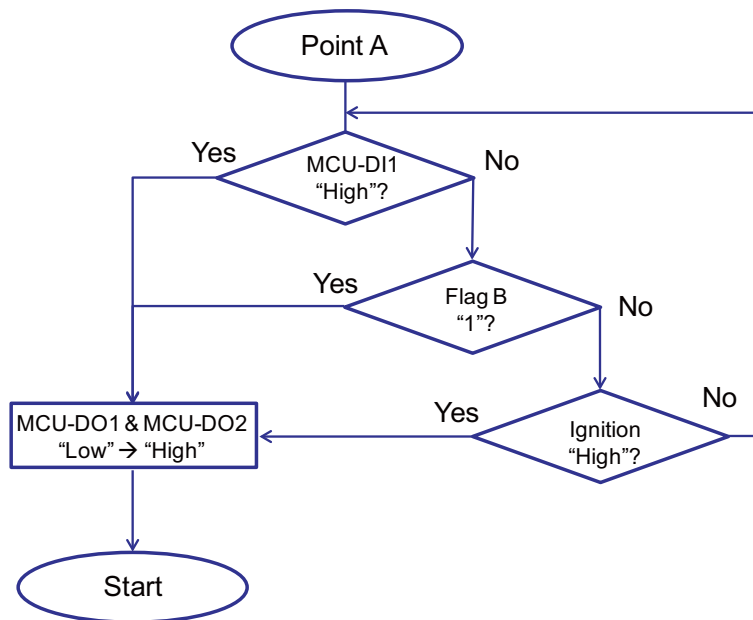

(For MCU-DI2)

Example: When Central Locking System is initiated (locking signal is received) by negative signal, select "Low" in the trigger threshold level for MCU-DI1.

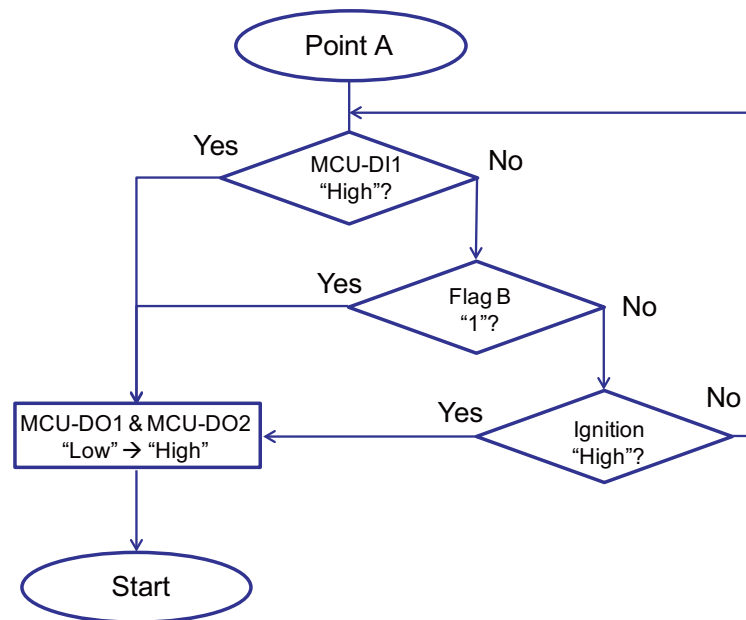

Appendix E: Vehicle Power Management Setup

External Power Output Setting

VTC series has four modes for external power output setting.

1. External +12V and By Pass Car Battery Turn On Simultaneously
2. External +12V and By Pass Car Battery Turn Off Simultaneously
3. External +12V Turn On Only
4. By Pass Car Battery Turn On Only



Startup and Shutdown Voltage Setting

Set the startup voltage to 11.5V or 23V and the shutdown voltage to 10.5V or 21V
If the input voltage is 12V: the startup voltage to 11.5V and the shutdown voltage to 10.5V.

If the input voltage is 24V: the startup voltage to 23V and the shutdown voltage to 21V.

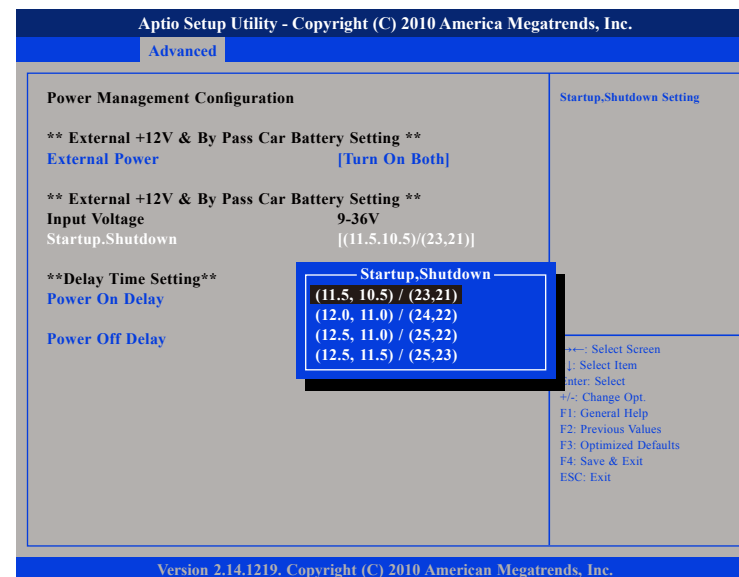

Set the startup voltage to 12.0V or 24V and the shutdown voltage to 11.0V or 22V

If the input voltage is 12V: the startup voltage to 12V and the shutdown voltage to 11V.

If the input voltage is 24V: the startup voltage to 24V and the shutdown voltage to 22V.

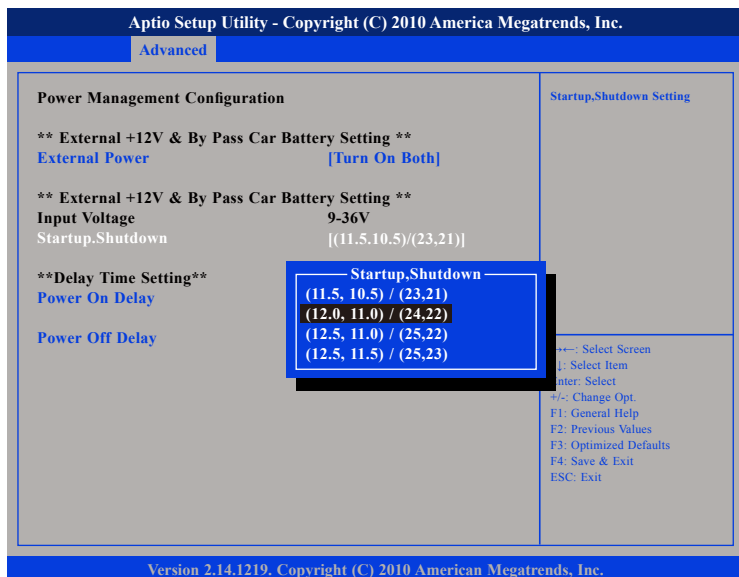

Set the startup voltage to 12.5V or 25V and the shutdown voltage to 11.0V or 22V

If the input voltage is 12V: the startup voltage to 12.5V and the shutdown voltage to 11V.

If the input voltage is 24V: the startup voltage to 25V and the shutdown voltage to 22V.

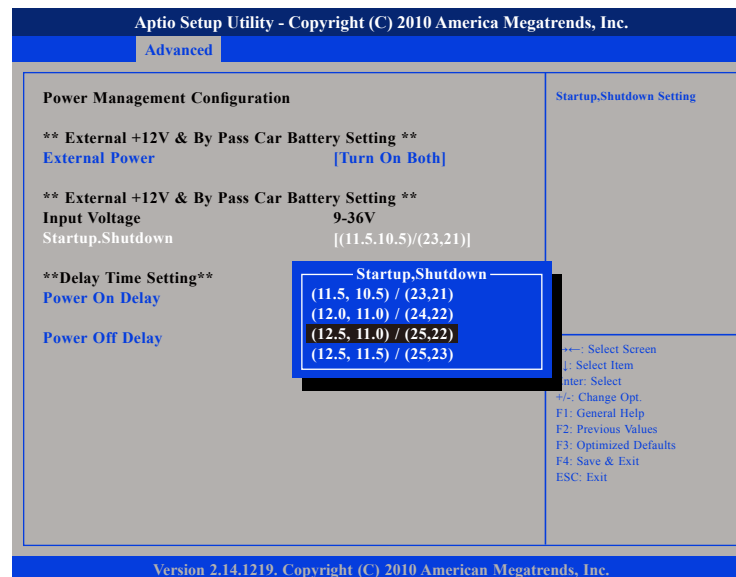

Set the startup voltage to 12.5V or 25V and the shutdown voltage to 11.0V or 22V

If the input voltage is 12V: the startup voltage to 12.5V and the shutdown voltage to 11.5V.

If the input voltage is 24V: the startup voltage to 25V and the shutdown voltage to 23V.

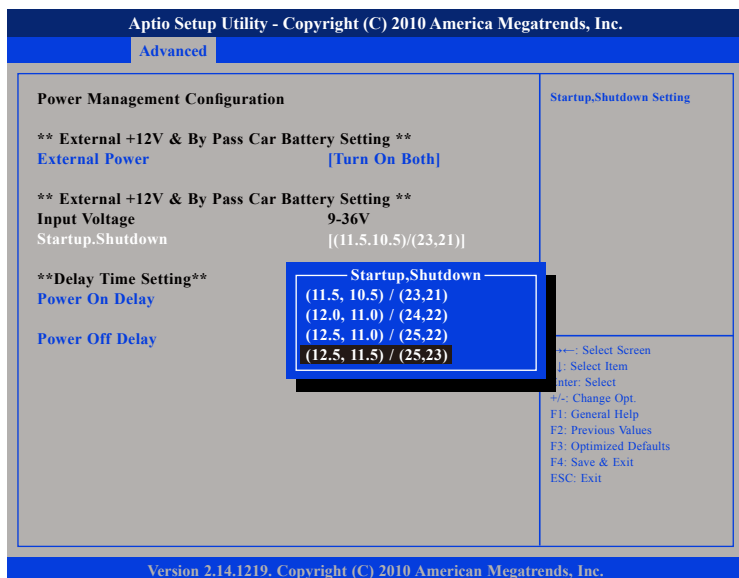

Power-on Delay Setting

Disable Power-on Delay



Enable Power-on Delay

Delay time can be set at 10sec/30sec/1min./5min./10min./15min./30min./1hour.

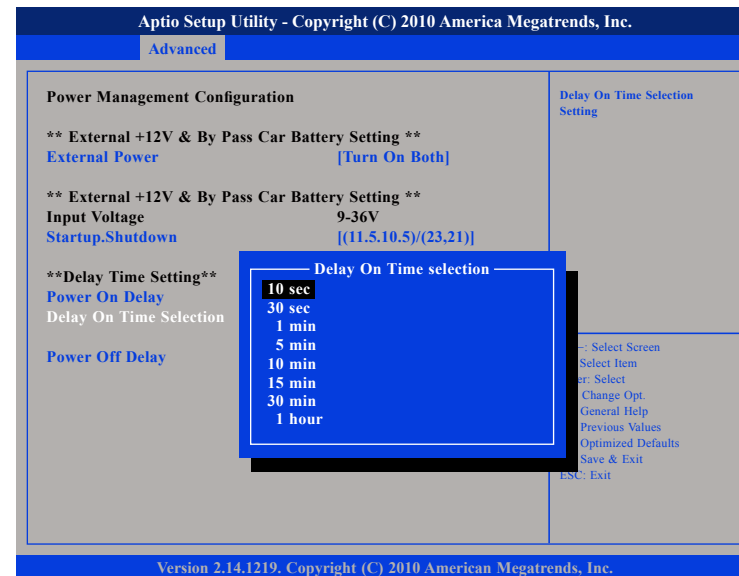

Power-off Delay Setting

Disable Power-off Delay



Enable Power-off Delay

Delay time can be set at 20sec/1min./5min./10min./30min./1hour/6hour/18hour.



Aptio Setup Utility - Copyright (C) 2010 America Megatrends, Inc.

Advanced

<p>Power Management Configuration</p> <p>** External +12V & By Pass Car Battery Setting ** External Power [Turn On Both]</p> <p>** External +12V & By Pass Car Battery Setting ** Input Voltage 9-36V Startup.Shutdown [(11.5,10.5)/(23,21)]</p> <p>**Delay Time Setting** Power On Delay</p> <p>Power Off Delay</p> <p>Delay Off Time Selection</p>	<p>Delay Off Time Selection Setting</p> -- Select Screen Select Item er. Select Change Opt. General Help Previous Values Optimized Defaults Save & Exit ESC: Exit
--	--

Delay On Time selection

20 sec

1 min

5 min

10 min

30 min

1 hour

6 hour

18 hour

Version 2.14.1219. Copyright (C) 2010 American Megatrends, Inc.

Appendix F: OBDII Module Setup and Command

OBDII Module

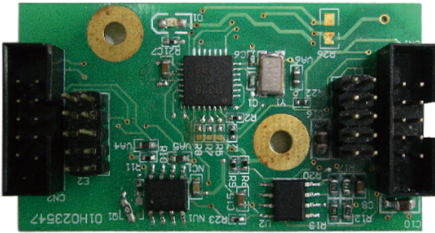

VTC series offer an option to integrate the OBDII module, VIOX-CAN01, into VTC system. The form factor of this VIOX-CAN01 is proprietary and it can support either SAE J1939 or SAE J1708 via connection in the first time. The maximum VIOX-CAN01 installed in VTC series is up to three units. Please note they are factory option.

VIOX-CAN01 Setup

When you start connecting VTC device to CAN bus device, you need a terminal program to send and receive data. To use the terminal program, please follow the setting below.

- (1) Set the proper corresponding "COM" port and its data rate is 9600
- (2) Set data bits at 8, stop bit at 1 and no parity bits.

After the setting, you will see the prompt with ">" character. This indicates that the device is in the idle state and ready to receive characters on the COM port.

If you do not see prompt string, please reset the device with ATR (reset) command and then press the return key:

>ATR or >AT R (spaces are optional; and case is in-sensitive).

You can also type HEX code instead:

"41", "54", "5A", "0D"

If you see strange characters instead of ">", you may set the incorrect baud rate. Please check baud rate. If you send the incorrect command, the device will show a single question mark ("?") to indicate your input is not understood. If VTC fails to link to the BUS, it will show "PLEASE REBOOT".

Once VTC connect to BUS, it will start to try which protocol is connected either J1939 or J1708. Once it is determined, it will only accept the successful protocol next time unless using ATR command to reset it. This means you can change the protocol by reset command. After the reset command, please power off the device and turn on it again.

In case, the device cannot find correct protocol after 180 seconds, it will enter sleeping mode for power saving.

There are several output format available for the different application including:

- (1) Simple Data by ASCII Code
- (2) Raw Data
- (3) Packaged Messages by ASCII or HEX code.

The default setting is Simple Data Format. The device will send messages out after it communicates with vehicle successfully. The output format can be changed via setting the AT command. Please refer the following section of AT command.

AT Command Summary

@1	AT@1: Display version information
BRxy	Setting RS232 baud rate. xy is baud rate parameter. ATBR09: 9600 ATBR19: 19200 ATBR38: 38400 ATBR57: 57600 ATBR99: 115200
Eh	ATE0: echo off(Default) ATE1; echo on
T	ATT: Terminate sending. To use ATS will continue it.
I	ATI : Request vehicle ID, the length is variable. 1.) J1708: Output format: ASCII code Byte 0:0x2A Byte 1: Vehicle ID byte 1 Byte 2: Vehicle ID byte 2 Byte N:Vehicle ID byte N Byte N+1: Check Sum=Byte 1+Byte2+.....+Byte N Byte N+2:0x0D Byte N+3:0x0A N: Max 20 2.)J1939 Byte 0:0x2A Byte 1: Vehicle ID byte 1 Byte 2: Vehicle ID byte 2 Byte N:Vehicle ID byte N Byte N+1: Check Sun= Byte1+Byte2 +.....ByteN Byte N+1:0x0D Byte N+2:0x0A N: Max 35

PA	ATPA: Print data by ASCII CODE format
PH	ATPH: Print data by HEX CODE format
RJ	ATRJ: Request J1939 FMS High Resolution Total Vehicle Distance #33~#36
RH	ATRH: Request Hino Truck Total vehicle distance (#33~#36)
S	ATS: Continue auto-send data every 100~200ms. To use ATT will terminal it.
SS	ATSS: Auto- send Simple Data every 100~200 ms. Refer to Simple Data format Protocol
SP	ATSP: Auto-send Packaging Messages every 100~200 ms. Refer to Packaging Messages protocol.
SR	ATSR: Auto-send J1939/J1708 Raw Data, Refer to Raw Data Protocol.
X	ATX: Request to send data of alternate, data format as ATS/ATSP command. For J1939 protocol: Packing1→Packing2→Packing 3→Packing4→Packing5→ Packing6→Packing1 For J1708 protocol: Packing1→Packing2→Packing 3→Packing4→Packing5→ Packing1
#xy	AT#xy: The command will print designated data by ASCII code. "xy" is data address, it is decimal. J1708: 00~53 J1939: 00~99. EX: AT#01 , to get speed high byte.

Simple Data Protocol: (ASCII CODE)

Data	Description
HEAD	@
Byte 0	,
Byte 1	Speed , (0~255) KM/HR
Byte 2	,
Byte 3	RPM High Byte (RPMHB)
Byte 4	,
Byte 5	RPM Low Byte(RPMLB) , RPM=RPMHB*256+RPMLB
Byte 6	,
Byte 7	Engine Loading, (0~100%)
Byte 8	,
Byte 9	Battery Voltage (BV), = (BV+100)/10 (v)
Byte 10	,
Byte 11	Engine Temperature(ET), =ET-40°C
Byte 12	,
Byte 13	Throttle position 0~100 %
Byte 14	,
Byte 15	Status , Note 2
Byte 16	,
Byte 17	MAF (0~255), MAF RATE= MAF * 3;
Byte 18	,
Byte 19	Distance : D1
Byte 20	,
Byte 21	Distance: D2
Byte 22	,
Byte 23	FU, Average Fuel Economy (km/L) =Fu /10
Byte 24	,

Byte 25	Check sum (odd numbers)= Byte1+ Byte3+Byte5+ Byte7+Byte9+Byte11+ Byte13+ Byte15+Byte17+ Byte19+Byte21+Byte23
Byte 26	Carry return (0x0D)
Byte 27	Line feed (0x0A)

Simple Data Protocol: (HEX CODE)

Data	Description
HEAD	@ (=0x40)
Byte 1	Speed , (0~255) KM/HR
Byte 2	RPM High Byte (RPMHB)
Byte 3	RPM Low Byte(RPMLB) , RPM=RPMHB*256+RPMLB
Byte 4	Engine Loading, (0~100%)
Byte 5	Battery Voltage (BV), = (BV+100)/10 (v)
Byte 6	Engine Temperature(ET), =ET-40°C
Byte 7	Engine Loading, (0~100%)
Byte 8	Status , Note 2
Byte 9	MAF (0~255), MAF RATE= MAF * 3;
Byte 10	Distance: D1
Byte 11	Distance: D2
Byte 12	FU, Average Fuel Economy (km/L) =Fu /10
Byte 13	TCheck sum (odd numbers)= Byte1+ Byte2+Byte3+ Byte4+ Byte5+Byte6+ Byte7+ Byte8+Byte9+ Byte10+ Byte11+Byte12
Byte 14	Carry return (0x0D)
Byte 15	Line feed (0x0A)

NOTE:

1.) Data format : ASCII CODE

@ , 7 8 , 0 E , 7 0 , 0 0 , 0 3 , 9 8 , 2 8 , Status ,MAF,D1,D2,Fu,CS
speed=78 km/hr

rpm=0x0E70= 3696

2.) status:

Bit 7:

0: Normal

1: Emergency Braking (Acceleration < - 6 m/s²)

Bit 6:

0: Brake OFF

1: Brake ON

Bit 5:

0: Clutch OFF

1: clutch ON

Bit 4:

0: Cruise Control OFF

1: Cruise Control ON

Bit 3:

0: Brake (ON/OFF) unavailable

1: Brake(ON/OFF) available

Bit 2:

0:Clutch (ON/OFF) unavailable

1: Clutch (ON/OFF) available

Bit 1:

0: Cruise Control (ON/OFF) unavailable

1: Cruise Control (ON/OFF) available

Bit 0:

0: NORMAL

1: DTC ON

2.) Distance = D1*256+D2

3.) Average Fuel Economy =Fu /10

J1939 Raw Data Protocol (HEX CODE)

Support for J1939 PGN / SPN access as defined in the J1939 standards. This function will report all PGNs and their source node on the J1939 network.

Each SPN under this function should be set to a size of 32 bits.

J1939	Format	
Byte 0	@ (=0x40)	
Byte 1	Bit4,3,2: Priority Bit0: Data Page Bit1,5,6,7:Reversed	
Byte 2	PDU Format (PF)	PGN
Byte 3	PDU Specific (PS)	
Byte 4	Source Address	
Byte 5	Data1	
Byte 6	Data2	
Byte 7	Data3	
Byte 8	Data4	
Byte 9	Data5	
Byte 10	Data6	
Byte 11	Data7	
Byte 12	Data8	
Byte 13	Check Sum	
Byte 14	0x0D	
Byte 15	0x0A	

J1708 Raw Data Protocol (HEX CODE)

This function will report all MID and PID that broadcasting on the J1708 network. Its data length is not fixed, please refer to SAEJ1708.

J1939	Format	PIDs 128-191	PIDs 0-127
Byte 0	@ (= 0x40)	@ (= 0x40)	@ (= 0x40)
Byte 1	Message identification (MID)	MID	MID
Byte 2	Parameter identification (PID)	PID	PID
Byte 3	Number of data bytes	Data1	Data1
Byte 4	Data 1	Data2	Check Sum
Byte 5	Data 2	Check Sum	0x0D
Byte 6	0x0D	0x0A
Byte 7	Data N	0x0A	
Byte 8	Check Sum		
Byte 9	0x0D		
Byte 10	0x0A		

PIDs 0-127 describe data parameters that are one byte long.

PIDs 128-191 describe data parameters that consist of two bytes.

PIDs 192-253 The first byte following these PIDs will contain the number of data parameter bytes.

EX:

MID=128

0x40	0x80	0x15	0x01	0x32	0xC8	0x0D	0x0A
64	128	21	1	50	200	130	10

PID=21 (Engine ECU temperature)

Data=50

J1939 Packaged Messages Protocol

S	ATS: send packaged messages by turns.		
	Response HEX CODE (default) after ATPH command		
	Packing 1: Byte 0: " @" , (0x40) Byte 1: " 1" , (0x31) Byte 2: #00 Byte 3: #01 Byte 19:#17 Byte 20: Check sum = Byte2 + ..+Byte 19 Byte 21: 0X0D Byte 22: 0X0A	Packing 2: Byte 0: " @" , (0x40) Byte 1: " 2" ,(0x32) Byte 2: #18 Byte 3: #19 Byte 19:#35 Byte 20: Check sum = Byte2 + ..+Byte 19 Byte 21: 0X0D Byte 22: 0X0A	Packing 3: Byte 0: " @" , (0x40) Byte 1: " 3" ,(0x33) Byte 2: #36 Byte 3: #37 Byte 19:#53 Byte 20: Check sum = Byte2 + ..+Byte 19 Byte 21: 0X0D Byte 22: 0X0A
Packing 4: Byte 0: " @" , (0x40) Byte 1: " a" ,(0x41) Byte 2: #54 Byte 3: #55 Byte 19:#71 Byte 20: Check sum = Byte2 + ..+Byte 19 Byte 21: 0X0D Byte 22: 0X0A	Packing 5: Byte 0: " @" , (0x40) Byte 1: " b" ,(0x42) Byte 2: #72 Byte 3: #73 Byte 19:#89 Byte 20: Check sum = Byte2 + ..+Byte 19 Byte 21: 0X0D Byte 22: 0X0A	Packing 6: Byte 0: " @" , (0x40) Byte 1: " c" ,(0x43) Byte 2: #90 Byte 3: #91 Byte 14:#102 Byte 19:0 Byte 20: Check sum = Byte2 + ..+Byte 19 Byte 21: 0X0D Byte 22: 0X0A	
NOTE : 1. AT#00 ~ AT#102 respond ASCII CODE format data. 2. Packing 6, Byte15~Byte19 not defined (set to "0") 3. After ATPA command, byte 21& 22 were ignored. 4. This is the common J1939 measurement overview showing which measurements are available. Note that not all measurements are supported by the individual engines.			

#00	Speed Low Byte (SLB)							
#01	Speed High Byte (SHB) speed=(SHB*256+SLB)/256							
#02	B7	B6	B5	B4	B3	B2	B1	B0
	Clutch switch 00 = pedal released 01 = pedal depressed		Brake switch 00 = pedal released 01 = pedal depressed		NOT USED		Cruise control active 00 = switched off 01 = switched on	
#03	B7	B6	B5	B4	B3	B2	B1	B0
	B7: Emergency brake(-6m/s2) B6: speed up (6m/s2) B5: Double Emergency brake (over -12m/s2) 1: Enable, 0:Disable			PTO state 00000 = off/disabled 00101 = Set 11111 = not available				
#04	0.4 % / Bit gain, Accelerator Pedal Position(APP) , 0 to 100 % APP= Data* 0.4							
#05	Engine Total Fuel used 0,5 L / Bit gain , ETF1							
#06	Engine Total Fuel used 0,5 L / Bit gain , ETF2							
#07	Engine Total Fuel used 0,5 L / Bit gain , ETF3							
#08	Engine Total Fuel used 0,5 L / Bit gain , ETF4 =((ETF4*256*256*256)+(ETF3*256*256)+(ETF2*256)+ETF1)*0.5							
#09	Fuel Level (FL) , 0 to 100 % , 0.4 %/bit Fuel Level=FL*0.4							
#10	RPM Low byte, RL							
#11	RPM High byte, RH RPM= (RH*256+ RL)* 0.125							

	B7	B6	B5	B4	B3	B2	B1	B0
	NOT USED				Engine Starter Mode			
#12	B7: 1, Total Vehicle Distance is provided by vehicle ECU 0, Total Vehicle Distance is calculation value							
	B3~B0:							
	0000 start not requested							
	0001 starter active, gear not engaged							
	0010 starter active, gear engaged							
	0011 start finished; starter not active after having been actively engaged ? (after 50ms mode goes to 0000)?							
	0100 starter inhibited due to engine already running							
	0101 starter inhibited due to engine not ready for start (preheating)							
	0110 starter inhibited due to driveline engaged							
	0111 starter inhibited due to active immobilizer							
	1000 starter inhibited due to starter over-temp							
	1001-1011 Reserved							
	1100 starter inhibited - reason unknown							
	1101 error							
	1111 not available							
#13	Axle location The value 0xFF indicates not available.							
	B7	B6	B5	B4	B3	B2	B1	B0
	Axle location Bit-mapped position number counting front to back facing forward F = not available position number, counting front to back on the vehicle. B7,B6,B5,B4 Axle location Bit-mapped position number counting front to back facing forward.				Tire location Bit-mapped counting left to right facing forward F = not available The low order 4 bits represent a position number, counting left to right when facing in the direction of normal vehicle travel			

#14	Axle weight 0.5 kg / Bit gain (Low Byte),AWL
#15	Axle weight 0.5 kg / Bit gain (High Byte), AWH Weight=(AWH*256+AWL)*0.5
#16	Engine total hours of Operation, EH1
#17	Engine total hours of Operation, EH2
#18	Engine total hours of Operation, EH3
#19	Engine total hours of Operation, EH4 Accumulated time=((EH4*256*256*256)+(EH3*256*256)+(EH2*256)+EH1)*0.05
#20 #27	Vehicle identification number, aabbccddeeffgghh (If the Vehicle ID contains more than 8 Bytes then #20~#27 are "00", please use ATI command to request.
#20	aa
#21	bb
#22	cc
#23	dd
#24	ee
#25	ff
#26	gg
#27	hh
#28	Engine Percent Load At Current Speed (0~125 %)
#29 #32	SW-version supported for trucks, Version number in the format ab.cd where this byte represents ASCII code #29 : "a" , #30: 'b', #31:'c' , #32:'d'
#33 #36	High Resolution Total Vehicle Distance, 5 m/bit, 0 to 21,055,406 km =((D4*256*256*256)+(D3*256*256)+(D2*256)+D1)*0.005 (KM)
#33	D1
#34	D2

#35	D3																
#36	D4																
#37	The distance which can be traveled by the vehicle before the next service inspection is required																
#38	$SERV=(V2*256+V1)*5-160635$ (KM)																
#37	V1																
#38	V2																
#39	<table border="1"> <thead> <tr> <th>B7</th> <th>B6</th> <th>B5</th> <th>B4</th> <th>B3</th> <th>B2</th> <th>B1</th> <th>B0</th> </tr> </thead> <tbody> <tr> <td colspan="2">Vehicle motion(B7,B6): 00 = Vehicle motion not detected 01 = vehicle motion detected</td> <td colspan="3">Driv. 2 working stat state (B5,B4,B3).G 000 = Rest 001 = Driver available 010 = Work 011 = Drive 110 = Error 111 = not available</td> <td colspan="3">Driv. 1 working state (B2,B1,B0): 000 = Rest 001 = Driver available 010 = Work 011 = Drive 110 = Error 111 = not available</td> </tr> </tbody> </table>	B7	B6	B5	B4	B3	B2	B1	B0	Vehicle motion(B7,B6): 00 = Vehicle motion not detected 01 = vehicle motion detected		Driv. 2 working stat state (B5,B4,B3).G 000 = Rest 001 = Driver available 010 = Work 011 = Drive 110 = Error 111 = not available			Driv. 1 working state (B2,B1,B0): 000 = Rest 001 = Driver available 010 = Work 011 = Drive 110 = Error 111 = not available		
	B7	B6	B5	B4	B3	B2	B1	B0									
Vehicle motion(B7,B6): 00 = Vehicle motion not detected 01 = vehicle motion detected		Driv. 2 working stat state (B5,B4,B3).G 000 = Rest 001 = Driver available 010 = Work 011 = Drive 110 = Error 111 = not available			Driv. 1 working state (B2,B1,B0): 000 = Rest 001 = Driver available 010 = Work 011 = Drive 110 = Error 111 = not available												
#40	<table border="1"> <thead> <tr> <th>B7</th> <th>B6</th> <th>B5</th> <th>B4</th> <th>B3</th> <th>B2</th> <th>B1</th> <th>B0</th> </tr> </thead> <tbody> <tr> <td colspan="2">Vehicle Overspeed</td> <td colspan="2">Driver 1 card</td> <td colspan="4">Driver 1 time related state</td> </tr> </tbody> </table> <p>Vehicle Over speed (B7,B6).GIndicates whether the vehicle is exceeding the legal speed limit set in the tachograph. 00 = No over speed 01 = Over speed Driver 1 card (B5,B4) 00 = Card not present 01 = Card present Driver 1 time related state (B3,B2,B1,B0).GIndicates if the driver approaches or exceeds working time limits (or other limits). 0000 = normal 0001 = 15 min bef. 4.5 h 0010 = 4.5 h reached 0011 = 15 min bef. 9 h 0100 = 9 h reached 0101 = 15 min bef. 16 h 0110 = 16h reached 1110 = Error 1111 = not available</p>	B7	B6	B5	B4	B3	B2	B1	B0	Vehicle Overspeed		Driver 1 card		Driver 1 time related state			
B7	B6	B5	B4	B3	B2	B1	B0										
Vehicle Overspeed		Driver 1 card		Driver 1 time related state													

#41	<table border="1"> <thead> <tr> <th>B7</th> <th>B6</th> <th>B5</th> <th>B4</th> <th>B3</th> <th>B2</th> <th>B1</th> <th>B0</th> </tr> </thead> <tbody> <tr> <td colspan="2">NOT USED</td> <td colspan="2">Driver 2 card (B5,B4) 00 = Card not present 01= Card present</td> <td colspan="4">Driver 2 time related state (B3,B2,B1,B0).GIndicates if the driver approaches or exceeds working time limits (or other limits). 0000 = normal 0001 = 15 min bef. 4.5 h 0010 = 4.5 h reached 0011 = 15 min bef. 9 h 0100 = 9 h reached 0101 = 15 min bef. 16 h 0110 = 16h reached 1110 = Error 1111 = not available</td> </tr> </tbody> </table>	B7	B6	B5	B4	B3	B2	B1	B0	NOT USED		Driver 2 card (B5,B4) 00 = Card not present 01= Card present		Driver 2 time related state (B3,B2,B1,B0).GIndicates if the driver approaches or exceeds working time limits (or other limits). 0000 = normal 0001 = 15 min bef. 4.5 h 0010 = 4.5 h reached 0011 = 15 min bef. 9 h 0100 = 9 h reached 0101 = 15 min bef. 16 h 0110 = 16h reached 1110 = Error 1111 = not available			
	B7	B6	B5	B4	B3	B2	B1	B0									
NOT USED		Driver 2 card (B5,B4) 00 = Card not present 01= Card present		Driver 2 time related state (B3,B2,B1,B0).GIndicates if the driver approaches or exceeds working time limits (or other limits). 0000 = normal 0001 = 15 min bef. 4.5 h 0010 = 4.5 h reached 0011 = 15 min bef. 9 h 0100 = 9 h reached 0101 = 15 min bef. 16 h 0110 = 16h reached 1110 = Error 1111 = not available													
#42	<table border="1"> <thead> <tr> <th>B7</th> <th>B6</th> <th>B5</th> <th>B4</th> <th>B3</th> <th>B2</th> <th>B1</th> <th>B0</th> </tr> </thead> <tbody> <tr> <td colspan="2">Direction indicator</td> <td colspan="2">Tachgraph performance</td> <td colspan="2">Handling information</td> <td colspan="2">System event</td> </tr> </tbody> </table> <p>Direction indicator (B7,B6).G 00 = Forward 01 = Reverse Tachgraph performance (B5,B4) 00 = Normal performance 01 = Performance analysis Handling information (B3,B2) 00 = no handling information 01 = handling information System event (B1,B0) 00 = no tachogr. Event 01 = tachogr. Event</p>	B7	B6	B5	B4	B3	B2	B1	B0	Direction indicator		Tachgraph performance		Handling information		System event	
B7	B6	B5	B4	B3	B2	B1	B0										
Direction indicator		Tachgraph performance		Handling information		System event											
#43	Tachogr. vehicle speed 1/256 km/h Bit gain																
#44	$Speed= ((VS2*256)+VS1)/256$																
#43	VS1																
#44	VS2																

#45	Engine Coolant Temperature(ECT) , -40 to 210 deg C ECT=data-40°C
#46	Engine Turbocharger Boost Pressure(ETBP), 2 kPa/bit , 0~500 KPA ETPB=data *2 (KPA)
#47	Engine Intake Manifold 1 Temperature(EIMT) , -40 to 210 deg C EIMT=data-40°C
#48	Bit7,6 Anti-Lock Braking (ABS) Active,G 00 - ABS passive but installed 01 - ABS active 10 – Reserved 11 - Not available Bit5~Bit0: Resvered.
#49	Brake Pedal Position (BPP), 0.4 %/bit, 0~100% BPP=data*0.4 (%)
#50	Parking and/or Trailer Air Pressure(PTAP), 8 kPa/bit PTAP=data *8 (KPA)
#51	Service Brake Air Pressure Circuit #1 (SBAPC1), 8 kPa/bit SBAPC1=data*8 (KPA)
#52	Service Brake Air Pressure Circuit #2 (SBAPC2), 8 kPa/bit SBAPC2=data*8 (KPA)
#53	Parking Brake Switch 00 = Parking brake not set 01 = Parking brake set
#54	Bit 1 ,Bit 0: Diagnostics supported 00 = diagnostics is not supported 01 = diagnostics is supported 10 = reserved 11 = don't care Bit 3 ,Bit 2: Requests supported 00 = request is not supported 01= request is supported 10 = reserved 11 = don't care Bit4~Bit7:Resvered

#55 #56	Ambient Air Temperature: Temperature of air surrounding vehicle. AAT=(AATH* 256+AATL)*0.03125 -273 deg C #55: AATL #56: AATH
#57	Door Control 1: Bit 7,Bit6: Status 2 of doors 00 = all bus doors disabled 01 = at least 1 bus door enabled 10 = error 11 = not available Bit 5, Bit4: Ramp/Wheel chairlift 00 = inside bus 01 = outside bus 10 = Error 11 = not available Bit 3,2,1,0 : Position of doors 0000 = at least 1 door is open 0001 = closing last door 0010 = all doors closed 1110 = Error 1111 = not available
#58 #56	Door Control 2, #58~#65 Lock Status: locked→doors cannot be operated by the driver or a passenger unlocked→door may be operated by the driver or a passenger Open Status: closed→door is completely closed open→door is not completely closed Enable Status: disabled→door cannot be opened by a passenger enabled→door can be opened by a passenger

#58	B7	B6	B5	B4	B3	B2	B1	B0
	Bit 7, Bit 6: Lock Status Door 2 00 = Unlocked 01 = Locked 10 = Error 11 = Not available		Bit 5, Bit 4: Enable Status Door 1 00 = Disabled 01 = Enabled 10 = Error 11 = Not available		Bit 3, Bit 2: Open Status Door 1 00 = Closed 01 = Open 10 = Error 11 = Not available		Bit 1, Bit 0: Lock Status Door 1 00 = Unlocked 01 = Locked 10 = Error 11 = Not available	
#59	B7	B6	B5	B4	B3	B2	B1	B0
	Bit 7, Bit 6: Open Status Door 3 00 = Closed 01 = Open 10 = Error 11 = Not available		Bit 5, Bit 4: Lock Status Door 3 00 = Unlocked 01 = Locked 10 = Error 11 = Not available		Bit 3, Bit 2: Enable Status Door 2 00 = Disabled 01 = Enabled 10 = Error 11 = Not available		Bit 1, Bit 0: Open Status Door 2 00 = Closed 01 = Open 10 = Error 11 = Not available	
#60	B7	B6	B5	B4	B3	B2	B1	B0
	Bit 7, Bit 6: Enable Status Door 4 00 = Disabled 01 = Enabled 10 = Error 11 = Not available		Bit 5, Bit 4: Open Status Door 4 00 = Closed 01 = Open 10 = Error 11 = Not available		Bit 3, Bit 2: Lock Status Door 4 00 = Unlocked 01 = Locked 10 = Error 11 = Not available		Bit 1, Bit 0: Enable Status Door 3 00 = Disabled 01 = Enabled 10 = Error 11 = Not available	
#61	B7	B6	B5	B4	B3	B2	B1	B0
	Bit 7, Bit 6: Lock Status Door 6 00 = Unlocked 01 = Locked 10 = Error 11 = Not available		Bit 5, Bit 4: Enable Status Door 5 00 = Disabled 01 = Enabled 10 = Error 11 = Not available		Bit 3, Bit 2: Open Status Door 5 00 = Closed 01 = Open 10 = Error 11 = Not available		Bit 1, Bit 0: Lock Status Door 5 00 = Unlocked 01 = Locked 10 = Error 11 = Not available	
#62	B7	B6	B5	B4	B3	B2	B1	B0
	Bit 7, Bit 6: Open Status Door 7 00 = Closed 01 = Open 10 = Error 11 = Not available		Bit 5, Bit 4: Lock Status Door 7 00 = Unlocked 01 = Locked 10 = Error 11 = Not available		Bit 3, Bit 2: Enable Status Door 6 00 = Disabled 01 = Enabled 10 = Error 11 = Not available		Bit 1, Bit 0: Open Status Door 6 00 = Closed 01 = Open 10 = Error 11 = Not available	

#63	B7	B6	B5	B4	B3	B2	B1	B0
	Bit 7, Bit 6: Enable Status Door 8 00 = Disabled 01 = Enabled 10 = Error 11 = Not available		Bit 5, Bit 4: Open Status Door 8 00 = Closed 01 = Open 10 = Error 11 = Not available		Bit 3, Bit 2: Lock Status Door 8 00 = Unlocked 01 = Locked 10 = Error 11 = Not available		Bit 1, Bit 0: Enable Status Door 7 00 = Disabled 01 = Enabled 10 = Error 11 = Not available	
#64	B7	B6	B5	B4	B3	B2	B1	B0
	Bit 7, Bit 6: Lock Status Door 10 00 = Unlocked 01 = Locked 10 = Error 11 = Not available		Bit 5, Bit 4: Enable Status Door 9 00 = Disabled 01 = Enabled 10 = Error 11 = Not available		Bit 3, Bit 2: Open Status Door 9 00 = Closed 01 = Open 10 = Error 11 = Not available		Bit 1, Bit 0: Lock Status Door 9 00 = Unlocked 01 = Locked 10 = Error 11 = Not available	
#65	B7	B6	B5	B4	B3	B2	B1	B0
	Bit 3, Bit 2: Enable Status Door 10 00 = Disabled 01 = Enabled 10 = Error 11 = Not available		Bit 1, Bit 0: Open Status Door 10 00 = Closed 01 = Open 10 = Error 11 = Not available					
#66 #71	Time / Date: #66 : Second=data * 0.25 #67 : Minutes=data #68 : Hours=data #69 : Month=data #70 : Day=data * 0.25 #71 : Year=data-1985 (1985 to 2235 years)							
	Alternator Status							
#72	B7	B6	B5	B4	B3	B2	B1	B0
	Bit 7, Bit 6: Alternator Status 4 00 = not charging 01 = charging 10 = error 11 = not available		Bit 5, Bit 4: Alternator Status 3 00 = not charging 01 = charging 10 = error 11 = not available		Bit 3, Bit 2: Alternator Status 2 00 = not charging 01 = charging 10 = error 11 = not available		Bit 1, Bit 0: Alternator Status 1 00 = not charging 01 = charging 10 = error 11 = not available	

#73	Selected Gear = data -125negative gear are reverse gears 00000000 = neutral 11111011 = park
#74	Current Gear=data-125 negative gear are reverse gears 00000000 = neutral 11111011 = park
#75 #76	Bellow Pressure Front Axle Left Information of the pressure of the air suspension bellow at the left side of the front axle Pressure= ((BPFAL2*256)+BPFAL1)* 0.1 ,KPA
#75	BPFAL1
#76	BPFAL2
#77 #78	Bellow Pressure Front Axle Right Information of the pressure of the air suspension bellow at the left side of the front axle Pressure= ((BPFAR2*256)+BPFAR1)* 0.1 ,KPA
#77	BPFAR1
#78	BPFAR2
#79 #80	Bellow Pressure Rear Axle Left Information of the pressure of the air suspension bellow at the left side of the front axle Pressure= ((BPRAL2*256)+BPRAL1)* 0.1 ,KPA
#79	BPRAL1
#80	BPFAR2
#81 #82	Bellow Pressure Rear Axle Right Information of the pressure of the air suspension bellow at the left side of the front axle Pressure= ((BPRAR2*256)+BPRAR1)* 0.1 ,KPA

#81	BPRAL1
#82	BPFAR2
#83	Driver's Identification (Driver 1 & Driver 2 identification)
	#83 #84 #85 #86 #87 #88 #89 #90
#90	The driver ID is only available if a digital tachograph is present
#91 #92	Engine Fuel Rate (EFR). Amount of fuel consumed by engine per liter of hour. EFR=(EFR2*256+EFR1)* 0.05 , L/h Data Range: 0 to 3,212.75 L/h
#91	EFR1
#92	EFR2
#93 #94	Engine Instantaneous Fuel Economy(EIFE). Current fuel economy at current vehicle velocity. EIFE=(EIFE2*256+EIFE1) / 512 , km/L Data Range: 0 to 125.5 km/L
#95	FMS Tell Tale Status
	#95 #96 #97 #98 #99 #100 #101 #102
#102	The Tell Tale Status information is derived from information displayed to the driver's dashboard.
#95	Bit 3,2,1,0: Telltale Block ID Bit 7,6,5,4: Telltale Status 1 1000 = off 1001 = Cond. Red 1010 = Cond. Yellow 1011 = Cond. Info 1100-1110 = Reserved 1111 = not available

#96	<p>Bit 3,2,1,0: Telltale Status 2 1000 = off 1001 = Cond. Red 1010 = Cond. Yellow 1011 = Cond. Info 1100–1110 = Reserved 1111 = not available</p> <p>Bit 7,6,5,4: Telltale Status 3 1000 = off 1001 = Cond. Red 1010 = Cond. Yellow 1011 = Cond. Info 1100–1110 = Reserved 1111 = not available</p>
#97	<p>Bit 3,2,1,0: Telltale Status 4 1000 = off 1001 = Cond. Red 1010 = Cond. Yellow 1011 = Cond. Info 1100–1110 = Reserved 1111 = not available</p> <p>Bit 7,6,5,4: Telltale Status 5 1000 = off 1001 = Cond. Red 1010 = Cond. Yellow 1011 = Cond. Info 1100–1110 = Reserved 1111 = not available</p>

#98	<p>Bit 3,2,1,0: Telltale Status 6 1000 = off 1001 = Cond. Red 1010 = Cond. Yellow 1011 = Cond. Info 1100–1110 = Reserved 1111 = not available</p> <p>Bit 7,6,5,4: Telltale Status 7 1000 = off 1001 = Cond. Red 1010 = Cond. Yellow 1011 = Cond. Info 1100–1110 = Reserved 1111 = not available</p>
#99	<p>Bit 3,2,1,0: Telltale Status 8 1000 = off 1001 = Cond. Red 1010 = Cond. Yellow 1011 = Cond. Info 1100–1110 = Reserved 1111 = not available</p> <p>Bit 7,6,5,4: Telltale Status 9 1000 = off 1001 = Cond. Red 1010 = Cond. Yellow 1011 = Cond. Info 1100–1110 = Reserved 1111 = not available</p>

#100	<p>Bit 3,2,1,0: Telltale Status 10 1000 = off 1001 = Cond. Red 1010 = Cond. Yellow 1011 = Cond. Info 1100–1110 = Reserved 1111 = not available</p> <p>Bit 7,6,5,4: Telltale Status 11 1000 = off 1001 = Cond. Red 1010 = Cond. Yellow 1011 = Cond. Info 1100–1110 = Reserved 1111 = not available</p>
#101	<p>Bit 3,2,1,0: Telltale Status 12 1000 = off 1001 = Cond. Red 1010 = Cond. Yellow 1011 = Cond. Info 1100–1110 = Reserved 1111 = not available</p> <p>Bit 7,6,5,4: Telltale Status 13 1000 = off 1001 = Cond. Red 1010 = Cond. Yellow 1011 = Cond. Info 1100–1110 = Reserved 1111 = not available</p>

#102	<p>Bit 3,2,1,0: Telltale Status 14 1000 = off 1001 = Cond. Red 1010 = Cond. Yellow 1011 = Cond. Info 1100–1110 = Reserved 1111 = not available</p> <p>Bit 7,6,5,4: Telltale Status 15 1000 = off 1001 = Cond. Red 1010 = Cond. Yellow 1011 = Cond. Info 1100–1110 = Reserved 1111 = not available</p>
------	---

J1708 Packaged Messages Protocol

S	Once AT1708 SLEEP, it can wake it up. Start to send data by 3 packing, response HEX CODE		
	Packing 1: Byte 0: " @", 0x40; Byte 1: 4 Byte 2: #00 Byte 3: #01 Byte 4: #02 Byte 5: #03 Byte 6: #04 Byte 7: #05 Byte 8: #06 Byte 9: #07 Byte 10: #08 Byte 11: #09 Byte 12: #10 Byte 13: #11 Byte 14: #12 Byte 15: #13 Byte 16: #14 Byte 17: #15 Byte 18: #16 Byte 19: #17 Byte 20: Check sum = Byte2 + ...+Byte 19 Byte 21: 0X0D Byte 22: 0X0A	Packing 2: Byte 0: " @", 0x40; Byte 1: 5 Byte 2: #18 Byte 3: #19 Byte 4: #20 Byte 5: #21 Byte 6: #22 Byte 7: #23 Byte 8: #24 Byte 9: #25 Byte 10: #26 Byte 11: #27 Byte 12: #28 Byte 13: #29 Byte 14: #30 Byte 15: #31 Byte 16: #32 Byte 17: #33 Byte 18: #34 Byte 19: #35 Byte 20: Check sum = Byte2 + ...+Byte 19 Byte 21: 0X0D Byte 22: 0X0A	Packing 3: Byte 0: " @", 0x40; Byte 1: 6 Byte 2: #36 Byte 3: #37 Byte 4: #38 Byte 5: #39 Byte 6: #40 Byte 7: #41 Byte 8: #42 Byte 9: #43 Byte 10: #44 Byte 11: #45 Byte 12: #46 Byte 13: #47 Byte 14: #48 Byte 15: #49 Byte 16: #50 Byte 17: #51 Byte 18: #52 Byte 19: #53 Byte 20: Check sum = Byte2 + ...+Byte 19 Byte 21: 0X0D Byte 22: 0X0A

Packing 4 & 5 will display only there is trouble code occurrence.		
Packing 4: Byte 0: " @" Byte 1: 7 Byte 2:a Byte 3:b Byte 4:c Byte 5:a Byte 6:b Byte 7:c Byte 8:a Byte 9:b Byte 10:c Byte 11:a Byte 12:b Byte 13:c Byte 14:a Byte 15:b Byte 16:c Byte 17: Check sum = Byte2 + ...+Byte 21 Byte 18: 0X0D Byte 19: 0X0A	Packing 5: Byte 0: " @" Byte 1: 8 Byte 2:a Byte 3:b Byte 4:c Byte 5:a Byte 6:b Byte 7:c Byte 8:a Byte 9:b Byte 10:c Byte 11:a Byte 12:b Byte 13:c Byte 14:a Byte 15:b Byte 16:c Byte 17: Check sum = Byte2 + ...+Byte 21 Byte 18: 0X0D Byte 19: 0X0A	
a — MID b — SID or PID of a standard diagnostic code. C — Diagnostic code character. Bits 4-1: Failure mode identifier (FMI)		
NOTE : The #00~#52 command respond that data are ASCII code.		

#00	Road Speed—Indicated vehicle velocity Maximum Range: 0.0 to 205.2 km/h (0.0 to 127.5 mph)
#01	speed=(SHB*256+SLB)/256
#00	Speed Low Byte (SLB)
#01	Speed High Byte (SHB)
#02	Cruise Control Status—State of the vehicle velocity control system (active, not active), and system switch (on, off), for various system operating modes. Bit 8: cruise mode 1=active/0=not active Bit 7: clutch switch 1=on/0=off Bit 6: brake switch 1=on/0=off Bit 5: accel switch 1=on/0=off Bit 4: resume switch 1=on/0=off Bit 3: coast switch 1=on/0=off Bit 2: set switch 1=on/0=off Bit 1: cruise control switch 1=on/0=off
#03	Brake Stroke Status—Identifies the current state of the vehicle foundation brakes. Bit 8-5: Axle number 1 to 16 (represented as 0 to 15) Bit 4-2: Brake status/Stroke adjustment 000 = OK 001 = Out of adjustment 010 = Delay brake return 011 = Brake pads worn 100 = Delayed brake application 101 = Reserved 110 = Error 111 = Not available Bit 1: 1 = Left wheel, 0 = Right wheel

#04	Percent Accelerator Pedal Position(PAPP)—Ratio of actual accelerator pedal position to maximum pedal position. Maximum Range: 0.0 to 102.0% PAPP= Data* 0.4
#05 #08	Total Fuel Used (Natural Gas)—Accumulated amount of fuel used during vehicle operation. Maximum Range: 0.0 to 2 147 483 648 kg (0.0 to 4 724 464 025 lb) TFU=((ETF4*256*256*256)+(ETF3*256*256)+(ETF2*256)+ETF1)*0.473
#05	Engine Total Fuel used 0473 L / Bit gain , ETF1
#06	Engine Total Fuel used 0,473 L / Bit gain , ETF2
#07	Engine Total Fuel used 0,473 L / Bit gain , ETF3
#08	Engine Total Fuel used 0,473 L / Bit gain , ETF4
#09	Fuel Level—Ratio of volume of fuel to the total volume of the primary fuel storage container. Maximum Range: 0.0 to 127.5% Fuel Level=FL * 0.5 %
#10 #11	Engine Speed (RPM)—Rotational velocity of crankshaft. Maximum Range: 0.0 to 16383.75 rpm
#11	RPM= (RH*256+ RL)* 0.25
#10	RPM Low byte, RL
#11	RPM High byte, RH
#12	Engine Oil Pressure(EOP)—Gage pressure of oil in engine lubrication system as provided by oil pump. Maximum Range: 0.0 to 879.0 kPa (0.0 to 127.5 lbf/in2) EOP=data * 3.45 KPA
#13	Throttle Position(TP)—The position of the valve used to regulate the supply of a fluid, usually air or fuel/air mixture, to an engine. 0% represents no supply and 100% is full supply. Maximum Range: 0.0 to 102.0% TP= data * 0.4%

#14	Cargo Weight—The force of gravity of freight carried. Maximum Range: 0.0 to 1 166 056.9 N (0.0 to 262 140.0 lbf) (Low Byte),AWL
#15	(High Byte), AWH Weight=(AWH*256+AWL)* 17.792 N
#16	Total Engine Hours(TEH)—Accumulated time of operation of engine. Maximum Range: 0.0 to 214 748 364.8 h TEH=((EH4*256*256)+(EH3*256*256)+(EH2*256)+EH1)*0.05
#16	Engine total hours of Operation, EH1
#17	Engine total hours of Operation, EH2
#18	Engine total hours of Operation, EH3
#19	Engine total hours of Operation, EH4
#20	Vehicle Identification Number—Vehicle Identification Number (VIN) as assigned by the vehicle manufacturer. “ATI” command can show max 20 character VIN
#27	
#85	
#96	
#20	
#21	
#22	
#23	
#24	aa
#21	bb
#22	cc
#23	dd
#24	ee
#25	ff
#26	gg
#27	hh

#28	PTO Engagement Control Status PTO output status: Bits 8-5: Reserved—all bits set to 1 Bits 4-3: PTO #2 engagement actuator status Bits 2-1: PTO #1 engagement actuator status NOTE—Each status will be described using the following nomenclature: 00 Off/Not active 01 On/Active 10 Error condition 11 Not available
#29	Average Fuel Economy AFE=((AFE2*256)+AFE1) *1.660 72 x 10 ⁻³ km/L
#30	
#29	AFE1
#30	AFE2
#31	Mass Air Flow—Mass air flow measured at the fresh air intake MAF=((MAF2*256)+MF1)* 0.125 kg/min
#32	
#31	MAF1
#32	MAF2
#33	Total Vehicle Distance(TVD)—Accumulated distance travelled by vehicle during its operation. Maximum Range: 0.0 to 691489743 km (0.0 to 429 496 729.5 mi) Bit Resolution: 0.161 km (0.1 mi) TVD=((D4*256*256*256)+(D3*256*256)+(D2*256)+D1)*0.161 (KM) If vehicle dose not provide TVD, AT1708 replace the information with the calculated distance, deviation is 0.5%, The first time connection AT1708 please command ATR to clear distance memory.
#36	

#33	D1
#34	D2
#35	D3
#36	D4
#37	Fuel Rate (Instantaneous)—Amount of fuel consumed by engine per unit of time.
#38	Maximum Range: 0.0 to 1.076 65 L/s FR=(V2*256+V1) * 16.428 x 106 L/s
#37	V1
#38	V2
#39	Total Vehicle Hours(TVH)—Accumulated time of operation of vehicle.
#40	Maximum Range: 0.0 to 214 748 364.8 h TVH=((H4*256*256*256)+(H3*256*256)+(H2*256)+H1)*0.05 (H)
#39	H1
#40	H2
#41	H3
#42	H4
#43	Reserved
#44	Percent Engine Load(PEL)—Ratio of current output torque to maximum torque available at the current engine speed. Maximum Range: 0.0 to 127.5% PEL=data * 0.5%
#45	Engine Coolant Temperature(ECT) , Maximum Range: 0.0 to 255.0 °F ECT= data °F
#46	Boost Pressure (BP)—Gage pressure of air measured downstream on the compressor discharge side of the turbocharger. Maximum Range: 0.0 to 219.8 kPa (0.0 to 31.875 lbf/in2) PB=data * 0.862 (KPA)

#47	Intake Manifold Temperature (IMT)—Temperature of precombustion air found in intake manifold of engine air supply system. Maximum Range: 0.0 to 255.0 °F IMT=data °F
#48	ABS Control Status Bits 8-7: ABS off-road function switch Bits 6-5: ABS retarder control Bits 4-3: ABS brake control Bits 2-1: ABS warning lamp 00 Off/Not active 01 On/Active 10 Error condition 11 Not available
#49	Parking Brake Switch Status—Identifies the state (active/inactive) of the parking brake switch. Bit 8: 1=active/0=inactive Bits 7-1: Undefined
#50	Brake Application Pressure (BAP) Maximum Range: 0.0 to 1055 kPa (0.0 to 153.0 lbf/in2) BAP=data *4.14 kPa
#51	Brake Primary Pressure (BPP)—Gage pressure of air in the primary, or supply side, of the air brake system. Maximum Range: 0.0 to 1055 kPa (0.0 to 153.0 lbf/in2) BPP=data* 4.14 (KPA)
#52	Brake Secondary Pressure—Gage pressure of air in the secondary, or service side, of the air brake system. Maximum Range: 0.0 to 1055 kPa (0.0 to 153.0 lbf/in2) BPP=data* 4.14 (KPA)
#53	Road Speed Limit Status :State (active or not active) of the system used to limit maximum vehicle velocity. Bit 8: 1=active/0=not active Bits 7-1: Undefined

J1708 Command Example

1.) >AT#h,

Response: "Data1" "Data2" "H0D" "H3E" by ASCII CODE.

EX1:

AT#1, to get vehicle speed, if speed is 255,

Display,

FF

>

(H46,H46, H0D,H3E).

2.) Trouble code :

40 37 80 8 CA 80 A AA 80 B AA 80 C AA 80 1 AA FC D A

Trouble code :

MID 128(H80)

PID 8(H8)

Diagnostic code character (CA), FMI= A , bit4~bit1

4.) ATI : request vehicle ID,

2A	31	47	31	4A	46	32	37	57	37	47	4A	31	37	38	32	32	37	0	0	0	27	0D	0A
	1	G	1	G	F	2	7	W	8	G	J	1	7	8	2	2	7				CS		

Country Manufactured	1	U.S.A.(1 or 4), Canada (2), Mexico (3), Japan (J), Korea (K), England (S), Germany (W), Italy (Z)
Manufacturer	G	
Vehicle Type	1	
Vehicle Features	JF27W	
Accuracy Check Digit	8	
Model Year	G	1988 (J), 1989 (K), 1990 (L), 1991 (M), 1992 (N), 1993 (P), 1994 (R), 1995 (S), 1996 (T), 1997 (V), 1998 (W), 1999 (X), 2000 (Y), 2001(1), 2002 (2), 2003 (3).....
Production Plant	J	
Sequential Number	178227	The sequence of the vehicle for production as it rolled of the manufacturers assembly line.

Appendix G: Power Consumption

Item 1

OS: Windows 8

Burn-in Software: Version 6.0

Device: 2G DDR3L and SSD

Idle Mode	Burn-in Mode	S3	S4	S5
0.75A/12V	1.1A/12V	0.1A/12V	0.05A/12V	0.05A/12V
9W	13.2W	1.2W	0.6W	0.6W

Item 2

OS: Windows 8

Burn-in Software: Version 6.0

Device: 8G DDR3L, SSD/CFast, GPS + OBDII module, WWAN, CAN 2.0B module, WLAN + Bluetooth card, capture card

Idle Mode	Burn-in Mode	S3	S4	S5
N/A	1.57A/12V	0.1A/12V	0.08A/12V	0.08A/12V
N/A	18.84W	1.2W	0.96W	0.96W