

NEW

Intelligence Point-of-Care Terminal

POCi-W22C-ULT5 | 22" Medical Panel PC with 8th Generation Intel® mobile ULT Core™ i7/i5 Processor

Features

- Medical-grade PPC powered by 14nm 8th generation Intel® Whiskey Lake U platform
- Aluminum front bezel (IP66) & PC/ABS rear cover (IP54)
- Chemical etching AG coating
- Modular PCIe x4 expansion slot
- Dual reading light
- FHD IPS panel with optional DICOM preset



» Intelligent Working Station

The POCi-W22C-ULT5 is a medical panel PC featuring AI, edge computing with rich expansion functions. It is ideal to work in many kinds of medical scenario such as radiology, telemedicine, endoscopy system or surgical working station.

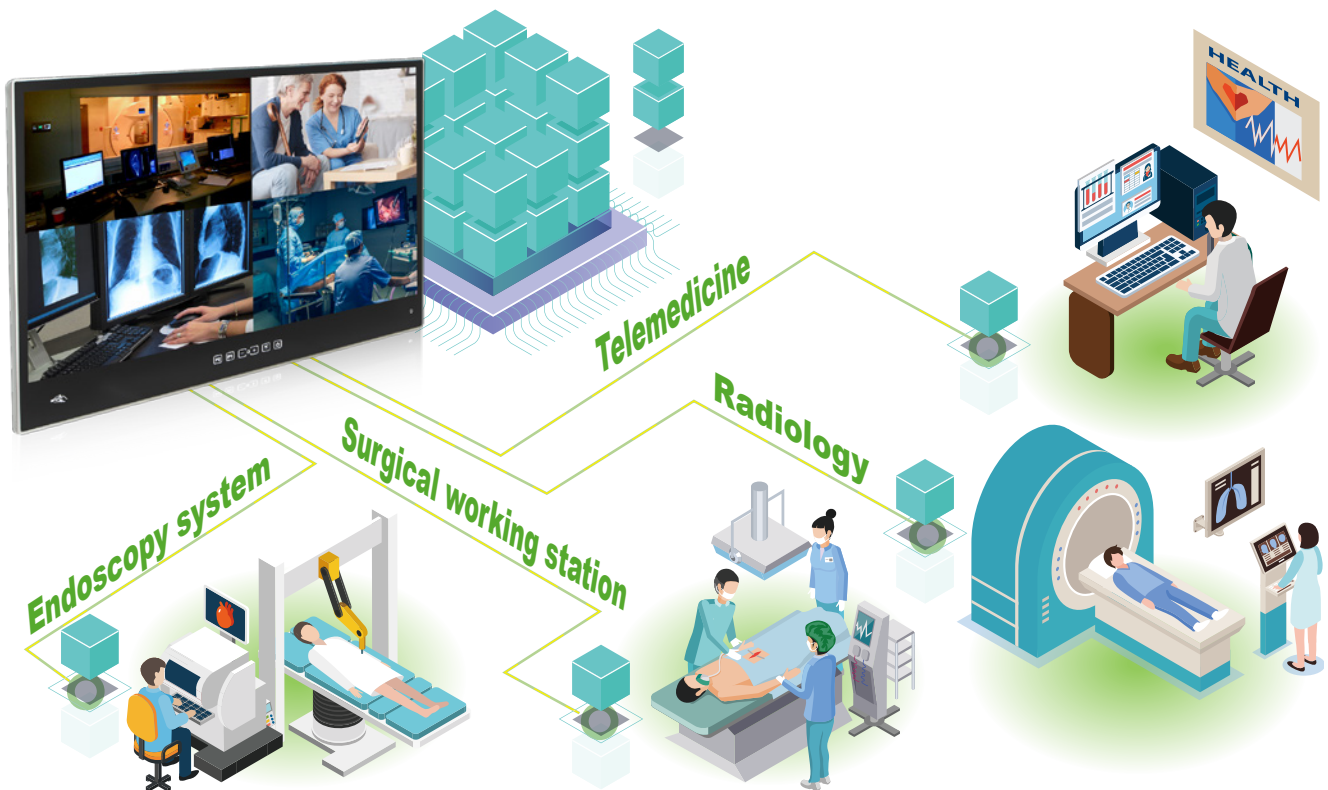

» Perfect Visual Performance

● Ultra Slim Front Bezel

Ultra slim front bezel creates a premium user experience. This design lets the medical personnel more focus on the clinical information displayed on the screen.

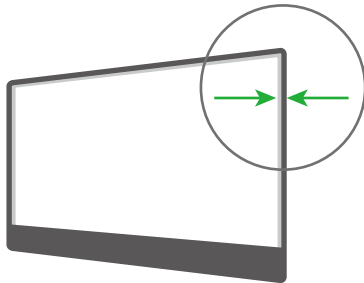

● IPS Panel with Chemical Etching AG Coating Glass

High-performance IPS panel enables a wider 178° viewing angles and advanced visual performance. Chemical etching AG coating reduces the watching fatigue resulting from glare or any other light interference in different kinds of environments.



● Optional DICOM Preset

The way the human eye responds to contrasts in light levels is not linear. At low levels, we can notice small changes in luminance. At higher luminance, the change needs to be much greater before we perceive the difference from one level to the next. Calibration of the display system is important to ensure that each image is shown consistently every time it is viewed.



● WiFi 6 module

POCi-W22C-ULT5 supports the latest WiFi 6 standard which enables more clients in dense environments and will provide a better experience for typical wireless LAN networks.

Key benefits of Wi-Fi CERTIFIED 6 technology include:

- Higher data rates
- Increased capacity
- Performance in environments with many connected devices
- Improved power efficiency



Feature	802.11ac (WiFi 5)	802.11ax (WiFi 6)
OFDMA	N/A	Shares channels to increase network efficiency and lower latency for both uplink and downlink traffic
Multi-user MIMO (MU-MIMO)	Available in Downlink direction	Available in Downlink and Uplink direction
Target Wake Time (TWT)	N/A	TWT reduces power consumption and medium access contention.
Bands	5GHz	2.4GHz & 5GHz, spanning to 1GHz - 7GHz eventually

● Easy Sterilization

Sterilization is the daily routine of the hospitals. Aluminum front frame is not only lightweight but also very durable for chemical erosion. The PC/ABS back cover is also carefully selected and proved to be resistant to the commonly seen detergents.

Cleaners / Disinfectants



High-Level Disinfectants



IP66 front bezel, IP54 back cover and true flat OSD button design with no inaccessible corner brings conveniences for the cleaning personnel and increases cleaning efficiency.



● Dual Reading Lights

The IEC 62471 compliant LEDs assure the reading light emits comfortable and safe light for human eyes. Easy adjustable dimming interface allows the user to choose the best brightness in different situations.



● Storage Device

POCi-W22C-ULT5 provides flexible storage device options

- 2.5" HDD/SSD
- M.2 M key slot for NVMe up to PCIe Gen3.0 x4

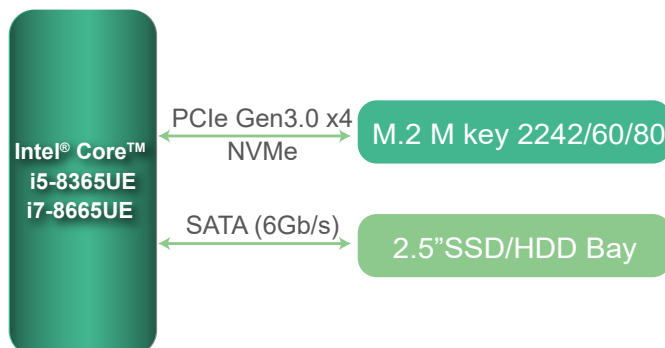

Storage Type	Width (W)	Height (H)
mSATA	30 mm	50.9 mm
2.5" SSD	69.85 mm	100.1 mm
M.2 2280	22 mm	80 mm

Interface	Bandwidth
M.2 SATA 6Gb/s	Mainstream 6Gb/s
M.2 PCIe 2.0 x2	1.0GB/s
M.2 PCIe 3.0 x4	3.94GB/s

● Accessible HDD Cover & Cable Cover

Users can easily manage all the cables from the I/O ports, preventing splash to IO ports or messy cabling. Accessible HDD cover makes the IT maintenance job more efficient.

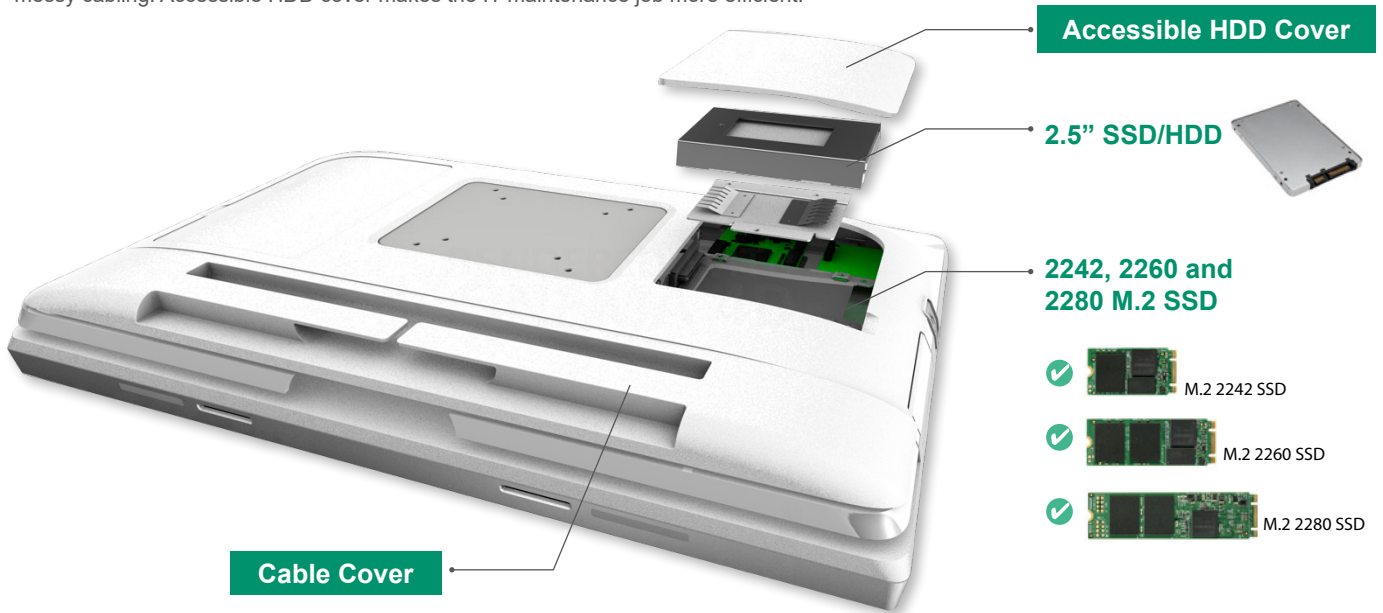

● Modular Expansion Design

Highly expandable PCIe x4 slot makes the whole system more flexible and easily meets the individual needs from different applications. For instance, adopting the Mustang-V100 to enhance computing power, adding an all-in-one capture card to connect with medical devices, integrating PoE injector card with webcam, or expanding the desired I/O card for multiple usage.



● Optional Built-in Battery

Uninterruptible Power System (UPS) is widely used in medical industry for securing patient's safety. The lateral expansion slot is available for a built-in battery which provides emergency power for 30 mins when the input source or main power fails under unexpected events.

* This feature needs to be chosen before product shipment only and it will against with the lateral PCIe x 4 expansion slot.



● Click-to-fix M.2 Slot

Special click-to-fix plunger design makes the M.2 replacing work much more convenient and prompt.

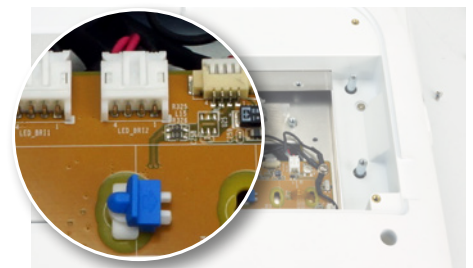
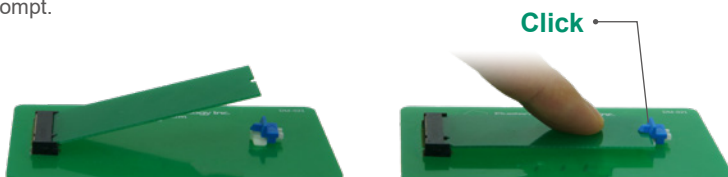

Specifications

Model		POCi-W22C-ULT5	
LCD Specifications	LCD Display	21.5" (16:9)	
	Max Resolution	1920 x 1080	
	Brightness (cd/m ²)	250	
	Contrast Ratio	1000:1	
	LCD Color	16.7M	
	Pixel Pitch (mm)	247.95 x 247.95	
	Viewing Angle (H-V)	178° / 178°	
	Backlight MTBF (hrs)	30000	
Touchscreen	Touchscreen	Projected capacitive type with USB interface	
	Touch Controller	EETI (80H84)	
	Surface Hardness	6H	
	Coating	Chemical etching AG	
	Multi-touch	Projected capacitive type with 10-point multi-touch	
System	CPU Support	Intel® Core™ i7-8665UE (Whiskey Lake ULT platform) Intel® Core™ i5-8365UE (Whiskey Lake ULT platform)	
	RAM	DDR4 SODIMM up to 32GB	
	LAN Controller	Intel® I219 Intel® I211	
	I/O Port	Bottom I/O 1 x DC Jack 1 x HDMI 1.4 out 1 x Gigabit Isolated LAN (i219 support Intel vPro) 1 x Gigabit Isolated LAN (i211) 1 x Isolated 1.5KV RS232 1 x combo Audio out / Mic in 4 x USB 3.2 Gen 2 port	Other 2 x USB 2.0 port (side)
	Storage	1 x 2.5" accessible SATA HDD/SSD bay 1 x M.2 2242/60/80 M key (PCIe x4)	
	Audio	2 x 3W speaker	
	Expansion Interface	1 x PCIe x4	
	LED	1 X RFID indicator Dual LED reading light	
	Wi-Fi and Bluetooth	IEEE 802.11 ax 2T2R module with Bluetooth V5.0 (M.2 2230)	
	Function Key	OSD Key	Power on/off Reading light on/off Brightness + Brightness -
Physical	Construction Material	Front bezel: Aluminum die-casting Rear cover: ABS+PC plastic with anti-bacterial material	
	Mounting	Wall, Stand and Arm VESA 75/100	
	Net Weight	6.9 kg	
	Dimensions (WxHxD)	507.5 x 335.5 x 64.1	
Environment	Operating Temperature	0°C~40°C	
	Storage Temperature	-20°C~60°C	
	Humidity	10% to 95% (non-condensing)	
	Vibration	1G	
	Shock	Operating shock: 5G peak acceleration (11ms duration) Non-Operating shock: 15G peak acceleration (11ms duration)	
	IP Level	Front: IP66 Back: IP54	
	Thermal	Fanless heatsink without fin	
Power	Power Input	19V DC input	
	Power Adapter	150W medical power adapter	
Certificate	EMC & Safety	CE, FCC Class B Part18 IEC 60601-1:2005+AMD1:2012 (Edition 3.1) IEC 60601-1-2: 2014 (Edition 4.0)	

Ordering Information

Part No.	Description
POCi-W22C-ULT5-i5/PC/4G-R10	21.5" 250cd/m ² FHD medical panel PC with 8th generation 14nm Intel® mobile Core™i5-8365UE (15W) 1.6GHz on-board processor (ULT),one 4GB DDR4 RAM,802.11 ax Wi-Fi module,PCAP touchscreen w/ AG coating,microphone,R10
POCi-W22C-ULT5-i7/PC/4G-R10	21.5" 250cd/m ² FHD medical panel PC with 8th generation 14nm Intel® mobile Core™i7-8665UE (15W) 1.7GHz on-board processor (ULT),one 4GB DDR4 RAM,802.11 ax Wi-Fi module,PCAP touchscreen w/ AG coating,microphone,R10

Options

Part No.	Description
MEDP-MF-RFID-R11	Mifare RFID reader, 13.56MHz, PN7362AUHN, with LED indicator, 250mm Antenna cable, IEI assembly only
MEDP-DICOM-R10	DICOM engine for digital image processing, including image enhancement, color adjustment and panel compensation,IEI assembly only
GPoE-2P-R20	PCI Express Power over Ethernet card, 2-port 1000 Base(T), 802.3at compliant, low profile, RoHS
POCP-CC06-R10	POCi-W22C-ULT5 cable cover,white, plastic, R10
TPM-IN03-R10	20-pin Infineon SPI TPM2.0 module, software mangement tool, firmware V7.63

Packing List

Item	Q'ty	Remark
Power Adapter	1	150W medical power adapter
Power Cord	1	European power cords, 183 CM, C13

POCi-W22C-ULT5 I/O Interface

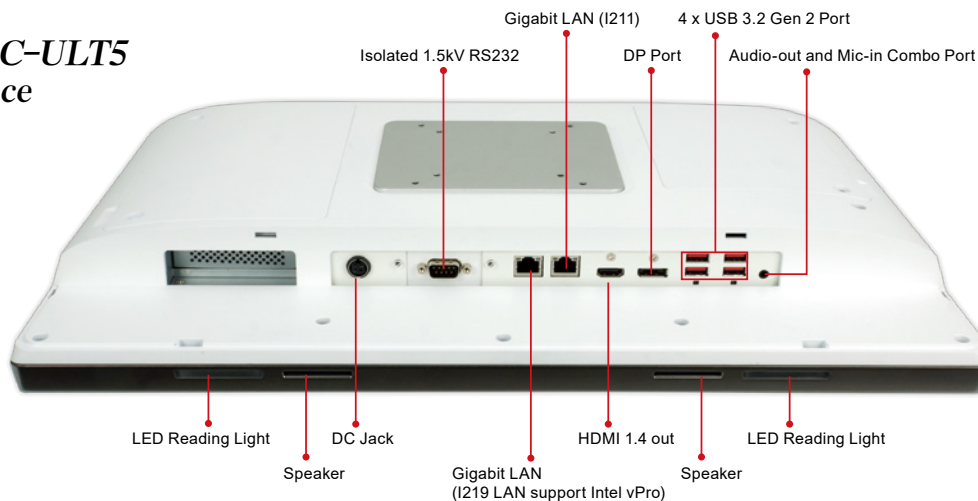

POCi-W22C-ULT5 Dimensions (Unit: mm)

