



User's Manual

PPC-090T-APL

Intel® Apollo Lake Processor

Compact Panel PC with 9" Resistive Touch Screen

PPC-090T-APL-N4-4G

PPC-090T-APL-N4-8G

PPC-090T-APL-N3-4G

PPC-090T-APL-N3-8G

PPC-090T-APL-**PN**4-4G

PPC-090T-APL-**PN**4-8G

PPC-090T-APL-**PN**3-4G

PPC-090T-APL-**PN**3-8G

(Revision 1.1A)

REVISION

DATE	VERSION	DESCRIPTION
2019/8/29	Version 1.0A	New Release
2021/8/26	Version 1.1A	Add Projected Capacitive Touch Solution.

ICOP TECHNOLOGY INC.

COPYRIGHT

The information in this manual is subject to change without notice for continuous improvement in the product. All rights are reserved. The manufacturer assumes no responsibility for any inaccuracies that may be contained in this document, and makes no commitment to update or to keep current the information contained in this manual.

No part of this manual may be reproduced, copied, translated or transmitted, in whole or in part, in any form or by any means without the prior written permission of the ICOP Technology Inc.

©Copyright 2021 ICOP Technology Inc.
Manual # IUMPPC090TAPL-01 Ver.1.1A Aug, 2021

TRADEMARKS ACKNOWLEDGMENT

Intel® Apollo Lake is the registered trademark of Intel Corporation. Other brand names or product names appearing in this document are the properties and registered trademarks of their respective owners. All names mentioned herewith are served for identification purpose only.

For more detailed information or if you are interested in other ICOP products, please visit our official websites at:

- Global: www.icop.com.tw
- USA: www.icoptech.com
- Japan: www.icop.co.jp
- Europe: www.icoptech.eu
- China: www.icop.com.cn

For technical support or drivers download, please visit our websites at:

- https://www.icop.com.tw/download_resource/PPC-090T-N4200?tags=18,81,34,35,38,39,64,65&selected=35

This Manual is for the PPC-090T-APL series.

SAFETY INFORMATION

- Read these Safety instructions carefully.
- Please carry the unit with both hands, handle carefully.
- Make sure the voltage of the power source is correct before connecting the equipment to the power outlet.
- Do not expose your Panel PC to rain or moisture in order to prevent shock and fire hazard.
- Input voltage +12VDC
- Operating temperature between 0~+60°C (+32~+140°F).
- Keep PPC-090T-APL away from humidity.
- When a M.2 2242 or 2.5" Hard Disk/SSD storage is the main operating system storage, please turn off power before inserting or removing. Do not open the cabinet to avoid electrical shock. Refer to your nearest dealer for qualified personnel servicing.
- Never touch un-insulated terminals or wire unless your power adaptor is disconnected.
- Locate your Panel PC as close as possible to the socket outline for easy access and to avoid force caused by entangling of your arms with surrounding cables from the Panel PC.
- USB connectors are not supplied with Limited Power Sources.
- If the equipment is not used for a long time, disconnect it from the power source to avoid damage by transient overvoltage.

WARNING!



DO NOT ATTEMPT TO OPEN OR TO DISASSEMBLE THE CHASSIS (ENCASING) OF THIS PRODUCT. PLEASE CONTACT YOUR DEALER FOR SERVICING FROM QUALIFIED TECHNICIAN.

Content

Content.....	iv
Ch. 1 General Information	1
1.1 Product Description	2
1.2 Product Specifications	3
1.3 Inspection standard for TFT-LCD Panel	5
1.4 Product Dimensions.....	9
1.5 Mounting Instruction	10
1.6 Ordering Information.....	12
Ch. 2 System Installation.....	14
2.1 CPU Board Outline	15
2.2 Connector Summary.....	16
2.3 Connector Pin Assignments.....	17
2.4 External I/O Overview.....	19
2.5 External I/O Pin Assignment.....	21
Ch. 3 Hardware Installation.....	23
3.1 Installing the M.2 2242 SATA.....	24
3.2 Installing the 2.5" SATA HDD/SDD	27
3.3 Installing the Mini-PCIe Module	30
3.4 Installing the Micro SIM Card (Must include 3G/4G Mini-PCIe Module in advance)	32
Ch. 4 Drivers and BIOS Instruction	33
4.1 Operating System Support and Drivers	34
4.2 BIOS Hot Key	35
4.3 BIOS COM1 Setting (RS232/422/485).....	36
4.4 BIOS COM2 Setting (Change Settings).....	38
4.5 BIOS AT Mode Setting (Support Auto-Power On Function)	40
4.6 BIOS Serial Port Console Redirection.....	42
4.7 BIOS Load Default Setting.....	44
Warranty.....	45

Ch. 1

General Information

[1.1 Product Description](#)

[1.2 Product Specifications](#)

[1.3 Inspection standard for TFT-LCD Panel](#)

[1.4 Product Dimensions](#)

[1.5 Mounting Instruction](#)

[1.6 Ordering Information](#)

1.1 Product Description

ICOP Technology Inc. is proudly going to release a brand new Panel PC, which offers fanless design, low power consumption, and IP65 front panel. The PPC-090T-APL is powered by Intel® Apollo Lake N4200/N3350 processor, and 4GB / 8GB SO-DIMM DDR3L module that handles processing more efficiently and provides faster performance. The project capacity touch panel with LED backlight TFT LCD increases operation convenience and visibility in outdoor environments. The ultra-compact and thin exterior design is perfect for the present demanding embedded and productive applications.

The new PPC-090T-APL inherited PPC series' smooth appearance and ultra-texture aluminum exterior design to make your industrial applications look more stylish. The versatile I/O ports, IP65 front panel, GIGA high-speed Ethernet etc. can fulfill fundamental functions. Our consistent advantages feature stable performance, extended working temperature support, low power consumption and fanless design. The expandable customize I/O ports can be accommodated connectivity requirements to industrial machine platforms and industrial automation equipment's needs.

The PPC-090T-APL supports Windows 10, Windows 10 IoT and Linux to meet ready-to-market demand and provide competitive advantages for customers.

1.2 Product Specifications

CPU BOARD SPECIFICATIONS

CPU	Intel® Apollo Lake N4200 (Quad core) Intel® Apollo Lake N3350 (Dual core; Optional)
Cache	L2: 2MB Cache
BIOS	AMI BIOS
Memory	4GB / 8GB DDR3L
Display	Intel® HD Graphics, HDMI 1.4 (As Dual Display)
LAN	Integrated 10/100/1000Mbps Ethernet x 1
Audio	HD Audio-Realtek ALC662VD CODEC
Internal Drives	2.5" SATA HDD/SSD Support (SATA III 6.0Gb/s) M.2 Slot Support (M-Key, SATA Interface, 2242)
I/O	HDMI x 1 RS232/422/485 (COM1) x 1 RS232 (COM2) x 1 USB3.0 x 2 USB2.0 x 1 RJ45 x 1 Audio-Out Mic-In

MECHANICAL & ENVIRONMENT

Power Adapter	+12VDC @ 3.33A (40W)
Operating Temperature	0~+60°C (+32~+140°F)
Storage Temperature	-20~+70°C (-4~ +158°F)
Operating Humidity	0% ~ 90% Relative Humidity, Non-Condensing
Dimensions	242.02x156.52x50.55mm (9.53"x6.12"x1.99")

Weight	1.50 Kg
Protection	IP65 Front Panel
Certification	CE / FCC / VCCI / Vibration/ Shock

LCD SPECIFICATIONS

Display Type	9" WSVGA TFT LCD
Backlight Unit	LED
Display Resolution	1024(W) x 600(H)
Brightness (cd/m ²)	300 nits
Contrast Ratio	500 : 1
Display Color	262,144
Pixel Pitch (mm)	190.5 (H) x 189 (V)
Viewing Angle	Vertical 120°, Horizontal 140°
Backlight Lifetime	20,000 hrs

TOUCHSCREEN

Type	Analog Resistive
Resolution	Continuous
Transmittance	80%
Controller	USB interface
Durability	1 million
Type2	Projected Capacitive Touch Screen (Optional)
Resolution	25ppi (Min.)
Transparency	86% ± 2%
Accuracy	Within 2.5mm each target
Surface Hardness	≥ 7H (Pressure : 0.5N/45°)

1.3 Inspection standard for TFT-LCD Panel

DEFECT TYPE			LIMIT				Note	
VISUAL DEFECT	INTERNAL	SPOT	$\varphi < 0.15\text{mm}$		Ignore		Note1	
			$0.15\text{mm} \leq \varphi \leq 0.5\text{mm}$		$N \leq 4$			
			$0.5\text{mm} < \varphi$		$N=0$			
		FIBER	$0.03\text{mm} < W \leq 0.1\text{mm}, L \leq 5\text{mm}$		$N \leq 3$		Note1	
			$1.0\text{mm} < W, 1.5\text{mm} < L$		$N=0$			
		POLARIZER BUBBLE	$\varphi < 0.15\text{mm}$		Ignore		Note1	
			$0.15\text{mm} \leq \varphi \leq 0.5\text{mm}$		$N \leq 2$			
			$0.5\text{mm} < \varphi$		$N=0$			
		Mura	It' OK if mura is slight visible through 6%ND filter					
ELECTRICAL DEFECT	BRIGHT DOT	A Grade			B Grade			
		C Area	O Area	Total	C Area	O Area	Total	Note3
		$N \leq 0$	$N \leq 2$	$N \leq 2$	$N \leq 2$	$N \leq 3$	$N \leq 5$	Note2
	DARK DOT	$N \leq 2$	$N \leq 3$	$N \leq 3$	$N \leq 3$	$N \leq 5$	$N \leq 8$	
	TOTAL DOT	$N \leq 4$			$N \leq 5$	$N \leq 6$	$N \leq 8$	Note2
	TWO ADJACENT DOT	$N \leq 0$	$N \leq 1$ pair	$N \leq 1$ pair	$N \leq 1$ pair	$N \leq 1$ pair	$N \leq 1$ pair	Note4
	THREE OR MORE ADJACENT DOT	NOT ALLOWED						
	LINE DEFECT	NOT ALLOWED						

(1) One pixel consists of 3 sub-pixels, including R, G, and B dot. (Sub-pixel = Dot)

(2) Little bright Dot acceptable under 6% ND-Filter.

(3) If require G0 grand (Total dot $N \leq 0$), please contact region sales.

[Note 1] W: Width[mm]; L: Length[mm]; N: Number; φ : Average Diameter.

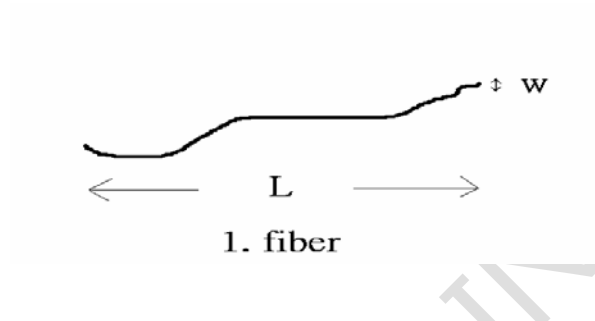
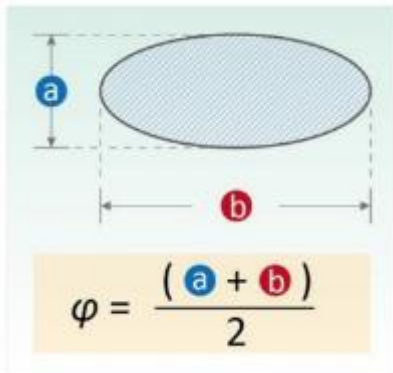

(a) White / Black Spot (b) Polarizer Bubble

[Note 2] Bright dot is defined through 6% transmission ND Filter as following.

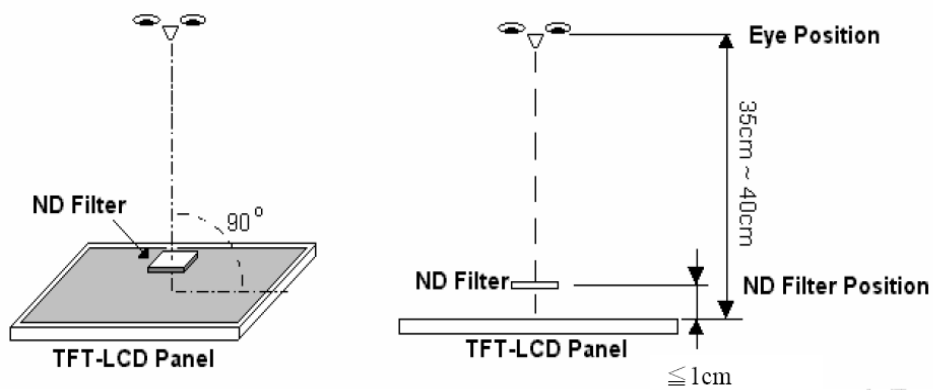

[Note 3] Display area

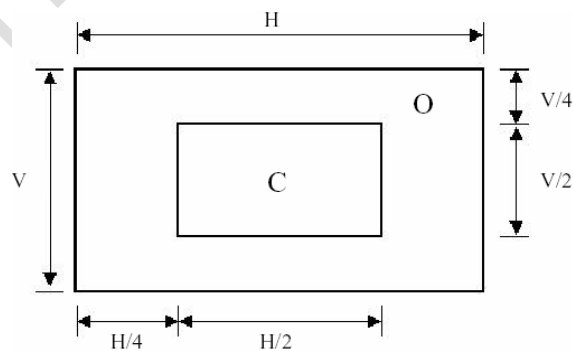

C Area: Center of display area O Area: Outer of display area

[Note 4] Judge the defect dot and the adjacent dot as following. Allow below (as A, B, C and D status) adjacent defect dots, including bright and dark adjacent dot. And they will be counted 2 defect dots in total quantity.

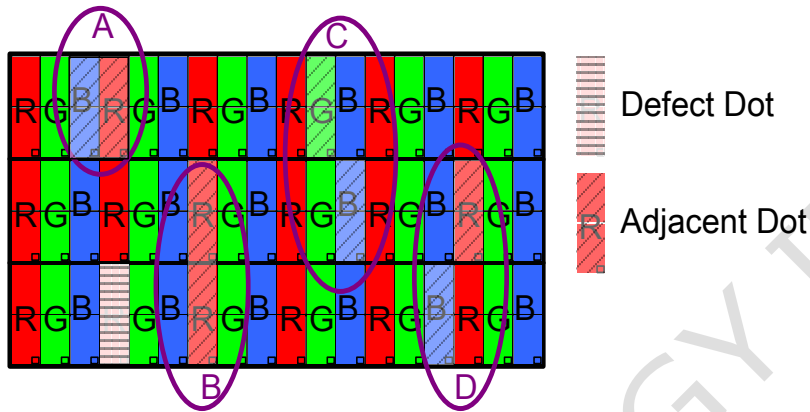

The defects that are not defined above and considered to be problem shall be reviewed and discussed by both parties.

Defects on the Black Matrix, out of Display area, are not considered as a defect or counted.

[Note 5]

According to the technical information from LCD manufacturer, the image retention may happen on LCD display if the static image is kept for a period of time without any change. ICOP will suggest customers not to have static image on LCD for over 4 hours without any image movement and also enable screensaver to avoid image sticking issue if LCD displays need to be kept on for a long time.

Some Image retention issue will disappear when LCD display is turned off for a period of time, but some image retention may be not reversible when LCD encounters screen burn.

The following is LCD manufacturer's test result for customers' reference.

TEST ITEMS	CONDITIONS	NOTE
High Temperature Operation	70°C ;240hrs	
High Temperature Storage	80°C ; 240hrs	
High Temperature High Humidity Operation	60°C ; 90%RH ;240hrs	No condensation
Low Temperature Operation	-20°C ; 240hrs	Backlight unit always turn on
Low Temperature Storage	-30°C ; 240hrs	
Thermal Shock	-30°C (0.5hr) ~	

	80°C (0.5hr) ; 200 Cycles	
Image Sticking	25°C ; 4hrs	Note 5-1
MTBF	20,000Hrs	

Note 5-1

1. Condition of Image Sticking test : 25 °C ± 2 °C.
2. Operation with test pattern sustained for 4 hrs, then change to gray pattern immediately.
3. After 5 mins, the mura must be disappeared completely.

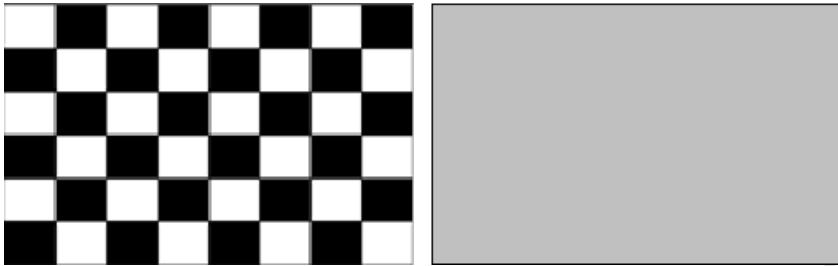

ICOP TECHNOLOGY INC.

1.4 Product Dimensions

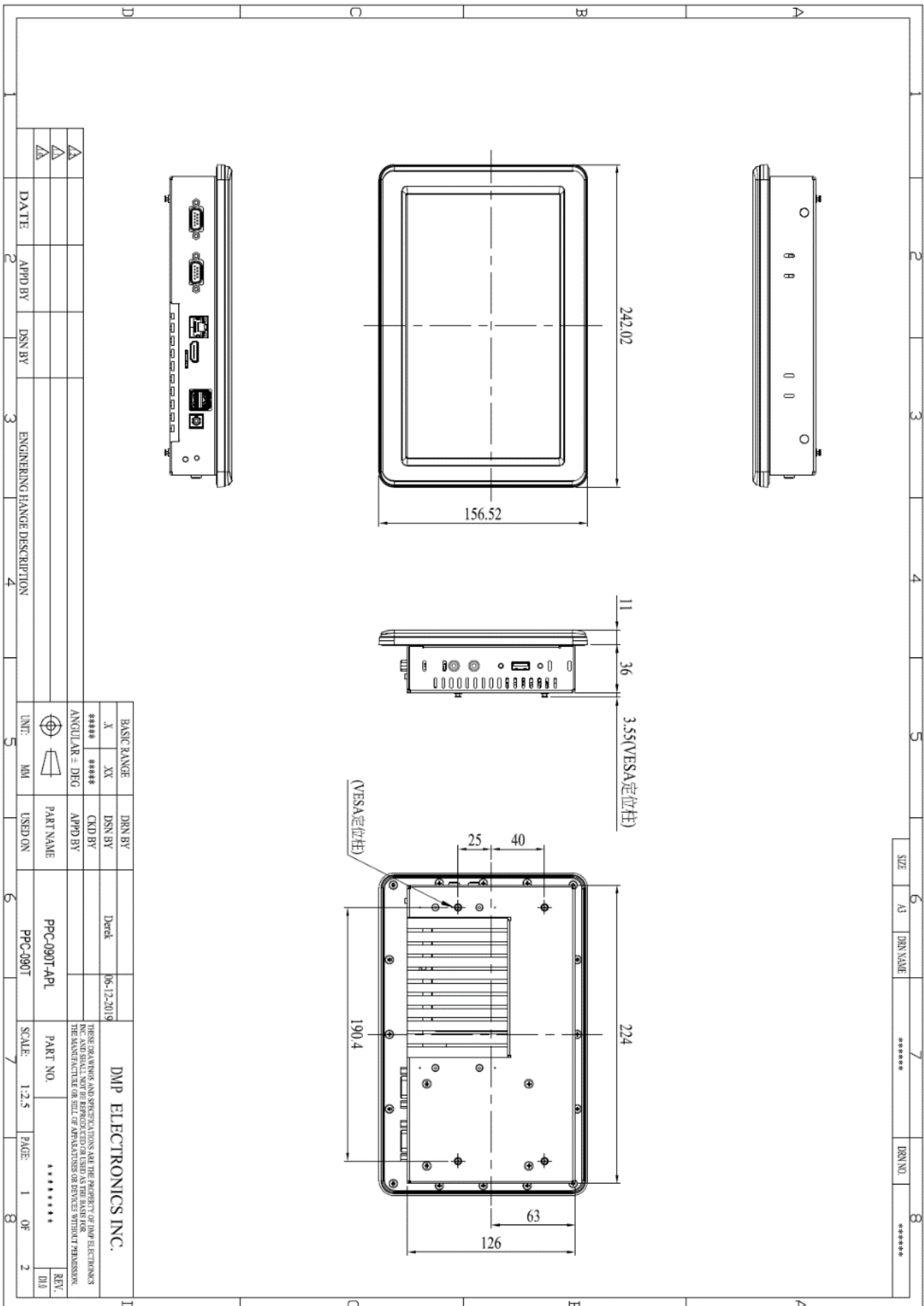

SIZE	A3	DRN NAME	*****	DRN NO.	*****
------	----	----------	-------	---------	-------

DATE	APPD BY	DSN BY	ENGINEERING CHANGE DESCRIPTION	UNIT	MM	USED ON	PPC-090T	SCALE	1:2.5	PAGE	1	OF	2
△				⊕			PPC-090T-APL						
△				∅									
△													

DMP ELECTRONICS INC.

THESE DRAWINGS AND SPECIFICATIONS ARE THE PROPERTY OF DMP ELECTRONICS. THE MANUFACTURE OR SELL OF APPLIANCES OR SERVICES WITHOUT PERMISSION.

1.5 Mounting Instruction

• 1.5.1 VESA Mounting

PPC-090T-APL series support VESA Mount that is an optional for ordering. Please contact your region sales for ordering.

Ordering part number: **VESA-MT-PPC-APL-SET**

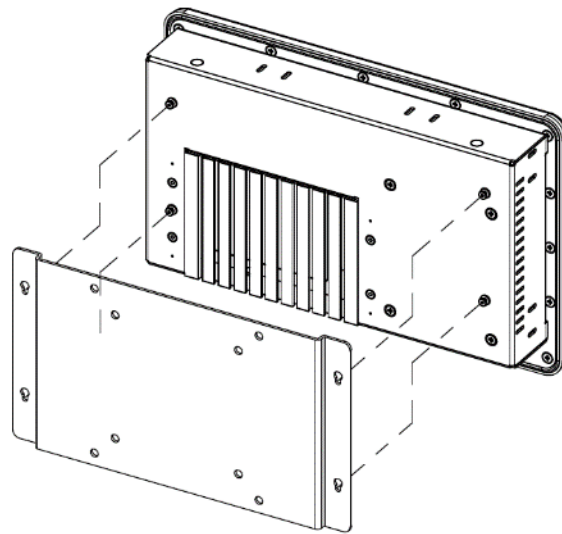

1. Place VESA bracket and VESA-MT-PPC-APL-SET together.
2. Lock 4 screws and nuts on both of VESA bracket and VESA-MT-PPC-APL-SET.



3. Hang PPC-090T-APL upon on both of VESA bracket and VESA-MT-PPC-APL-SET.



• 1.5.2 Panel Mounting

PPC-090T-APL series support clamp mount kit, which includes 4pcs of clamp and screw in a bag of the package box. User can follow the instruction to do the panel mount as below.

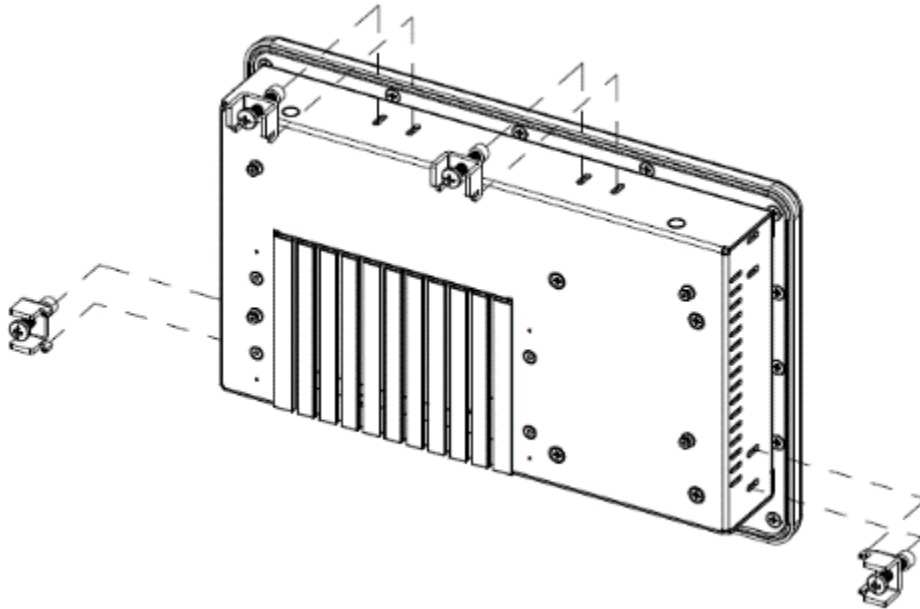

1. Please refer the Section 1.4 to make a cutout hole on your mechanical or frame. **Please note that there is thickness limitation of the mounting wall for clamp mount installation. The suggestion of mounting wall thickness limitation is 20 mm.**
2. It has 4pcs of clamp and screw, and each clamp and screw is paired. Screws 4pcs of clamp and screw together respectively.
3. Place PPC in a cutout mechanical or frame, which mounts the panel to align the bottom of the panel housing with the bottom edge of the cutout. This way can help hold the panel steadily.
4. At the back side of the mounting wall, insert the clamp into the slide hole at the side bracket on the panel. Fit the screw on the clamp and screw on both of clamp and mounting wall. Please be careful and make sure that 6 clamps and screws have been lock tightly.

1.6 Ordering Information

Product Code	LCD Size	CPU	CPU Type	RAM
PPC	090T	APL	N4	4G
			N3	8G
			PN4	
			PN3	

1. Product Code :

PPC : Panel PC Series.

2. LCD Size :

090T : 9" LCD Panel.

3. CPU :

APL : Intel Apollo Lake Processor.

4. CPU Type :

N4: N4200 Processor with Resistive Touch. **(Quad Core 6W)**

N3: N3350 Processor with Resistive Touch. **(Dual Core 6W)**

PN4: N4200 Processor with **PCAP** Touch. **(Quad Core 6W)**

PN3: N3350 Processor with **PCAP** Touch. **(Dual Core 6W)**

5. RAM :

4G : 4GB. 8 : 8GB.

PS: Power adapter and cord must be showed separate because different county has different power cord. The unit price includes power adapter and cord as below.

POWER-12V3.33A-MW

POWERCABLE(A) / POWERCABLE(G)

PART NUMBER	DESCRIPTION
PPC-090T-APL-N4-4G	9" Panel PC w/Intel Apollo Lake N4200/4GB DRAM /3U/Giga LAN/2S/RTP/DC12V Power Input
PPC-090T-APL-N4-8G	9" Panel PC w/Intel Apollo Lake N4200/8GB DRAM /3U/Giga LAN/2S/RTP/DC12V Power Input
PPC-090T-APL-N3-4G	9" Panel PC w/Intel Apollo Lake N3350/4GB DRAM /3U/Giga LAN/2S/RTP/DC12V Power Input
PPC-090T-APL-N3-8G	9" Panel PC w/Intel Apollo Lake N3350/8GB DRAM /3U/Giga LAN/2S/RTP/DC12V Power Input
PPC-090T-APL-PN4-4G	9" Panel PC w/Intel Apollo Lake N4200/4GB DRAM /3U/Giga LAN/2S/ PCAP /DC12V Power Input
PPC-090T-APL-PN4-8G	9" Panel PC w/Intel Apollo Lake N4200/8GB DRAM /3U/Giga LAN/2S/ PCAP /DC12V Power Input
PPC-090T-APL-PN3-4G	9" Panel PC w/Intel Apollo Lake N3350/4GB DRAM /3U/Giga LAN/2S/ PCAP /DC12V Power Input
PPC-090T-APL-PN3-8G	9" Panel PC w/Intel Apollo Lake N3350/8GB DRAM /3U/Giga LAN/2S/ PCAP /DC12V Power Input
POWER-12V3.33A-MW	AC – DC power adapter / DC12V @ 3.33A (AC 90 ~ 240V Input)
POWERCABLE(A) / POWERCABLE(G)	US/Euro power cord for POWER-12V3.33A-MW
VESA-MT-PPC-APL-SET	VESA mount bracket set
PANEL-MT-PPC-APL-SET	Panel Mount set for PPC Intel Apollo Lake series
WLAN KIT (Optional)	MINIPCIE-WLAN-159H (or 161H) x1 CASE-H2F-MINIPCIE x1 WIRELESS-ANTENNA-157 x1 WIRELESS-CABLE-UFL x1

Ch. 2

System Installation

[2.1 CPU Board Outline](#)

[2.2 Connector Summary](#)

[2.3 Connector Pin Assignments](#)

[2.4 External I/O Overview](#)

[2.5 External I/O Pin Assignment](#)

2.1 CPU Board Outline

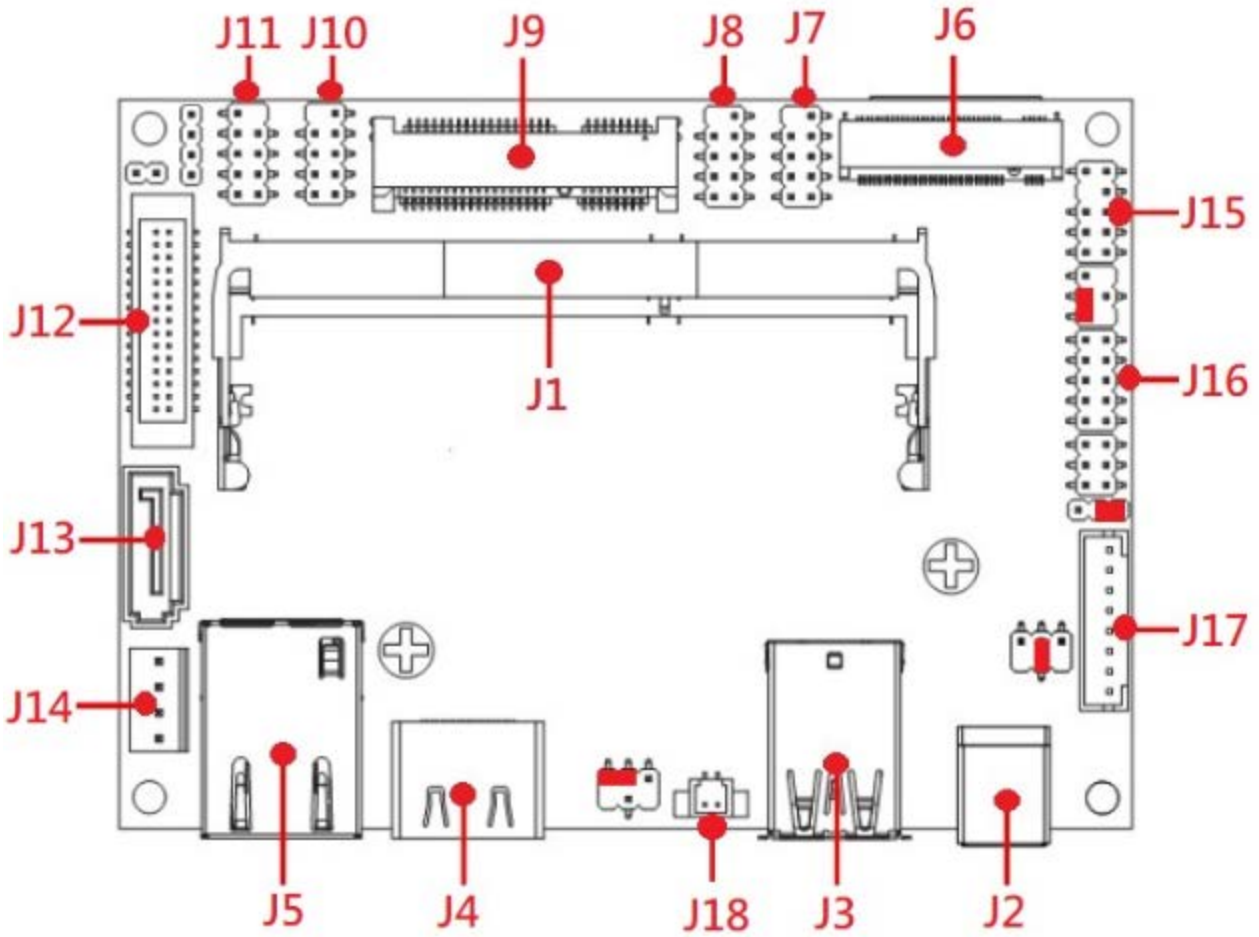

PPC APL CPU Board

2.2 Connector Summary

No.	Description	Type of Connections	Pin #
J1	DDR3L SO-DIMM Slot	External SO-DIMM Slot	204-pin
J2	Power DC Jack	External Power DC Jack Connector	2-pin
J3	USB3.0 x 2	External Dual USB3.0 Connector	18-pin
J4	HDMI	External HDMI Connector	19-pin
J5	GIGA Ethernet	External RJ45 Connector	8-pin
J6	M.2 SATA (M-Key)	External M.2 SATA Connector	75-pin
J7	COM1 (RS232/422/485)	2.0mm 9-pin pin header	9-pin
J8	COM2 (RS232)	2.0mm 9-pin pin header	9-pin
J9	Mini-PCle	External Mini-PCle Connector	52-pin
J10	Front Panel Header	2.0mm 9-pin pin header	9-pin
J11	USB2.0 x 2	2.0mm 9-pin pin header	9-pin
J12	LVDS	1.25mm 30-pin box header	30-pin
J13	SATAIII Slot	External SATA Slot	7-pin
J14	SATA Power Output	2.54mm 4-pin pin header	4-pin
J15	Audio Header	2.0mm 9-pin pin header	9-pin
J16	GPIO Header (Reserved)	2.0mm 10-pin pin header	10-pin
J17	Inverter	2.0mm 8-pin box header	8-pin
J18	RTC Battery Header	1.25mm 2-pin box header	2-pin

2.3 Connector Pin Assignments

J2: Power DC Jack

Pin #	Signal Name
1	+12V Power Input
2	GND

J7: COM1 (RS232/422/485)

Pin #	Signal Name	Pin #	Signal Name
1	DCD1 /422TX- /RS485-	2	DSR1
3	RXD1 /422TX+ /RS485+	4	RTS1
5	TXD1/422RX+	6	CTS1
7	DTR1/422RX-	8	RI1
9	GND		

J8: COM2 (RS232)

Pin #	Signal Name	Pin #	Signal Name
1	DCD2	2	DSR2
3	RXD2	4	RTS2
5	TXD2	6	CTS2
7	DTR2	8	RI2
9	GND		

J10: Front Panel Header

Pin #	Signal Name	Pin #	Signal Name
1	HDDLED+	2	PWRLED+
3	HDDLED-	4	PWRLED-
5	GND	6	PWRBT
7	RSTSW	8	GND
9	VCC		

J11: USB2.0 x 2

Pin #	Signal Name	Pin #	Signal Name
1	VCC	2	VCC
3	USB2_D1-	4	USB2_D2-
5	USB2_D1+	6	USB2_D2+
7	GND	8	GND
		10	NC

J12: LVDS

Pin #	Signal Name	Pin #	Signal Name
1	LVDSB_D3-	2	LVDSB_D3+
3	LVDSB_CLK-	4	LVDSB_CLK+
5	LVDSB_D2-	6	LVDSB_D2+
7	LVDSB_D1-	8	LVDSB_D1+
9	LVDSB_D0-	10	LVDSB_D0+
11	NC/DDC_DAT	12	NC/DDC_CLK
13	GND	14	GND
15	GND	16	GND
17	LVDSA_D3+	18	LVDSA_D3-
19	LVDSA_CLK+	20	LVDSA_CLK-
21	LVDSA_D2+	22	LVDSA_D2-
23	LVDSA_D1+	24	LVDSA_D1-
25	LVDSA_D0+	26	LVDSA_D0-
27	LCD_VDD	28	LCD_VDD
29	LCD_VDD	30	LCD_VDD

J14: SATA Power Output

Pin #	Signal Name
1	+5V
2	GND
3	GND
4	+12V

J18: RTC Battery Header

Pin #	Signal Name
1	GND
2	VBAT

J15: Audio Header

Pin #	Signal Name	Pin #	Signal Name
1	MIC_L	2	AUDIO_GND
3	MIC_R	4	AUDIO_JD
5	LINEOUT2_R	6	MIC_JD
7	SENSE_FB		
9	LINEOUT2_L	10	LINE2_JD

J16: GPIO (Reserved)

Pin #	Signal Name	Pin #	Signal Name
1	GPIO80	2	GPIO81
3	GPIO82	4	GPIO83
5	GPIO84	6	GPIO85
7	GPIO86	8	GPIO87
9	GND	10	VCC

J17: Inverter

Pin #	Signal Name
1	Backlight_Enable
2	Backlight_PWM
3	Backlight LED VCC
4	Backlight LED VCC
5	GND
6	GND
7	Backlight UP SW
8	Backlight DN SW

2.4 External I/O Overview

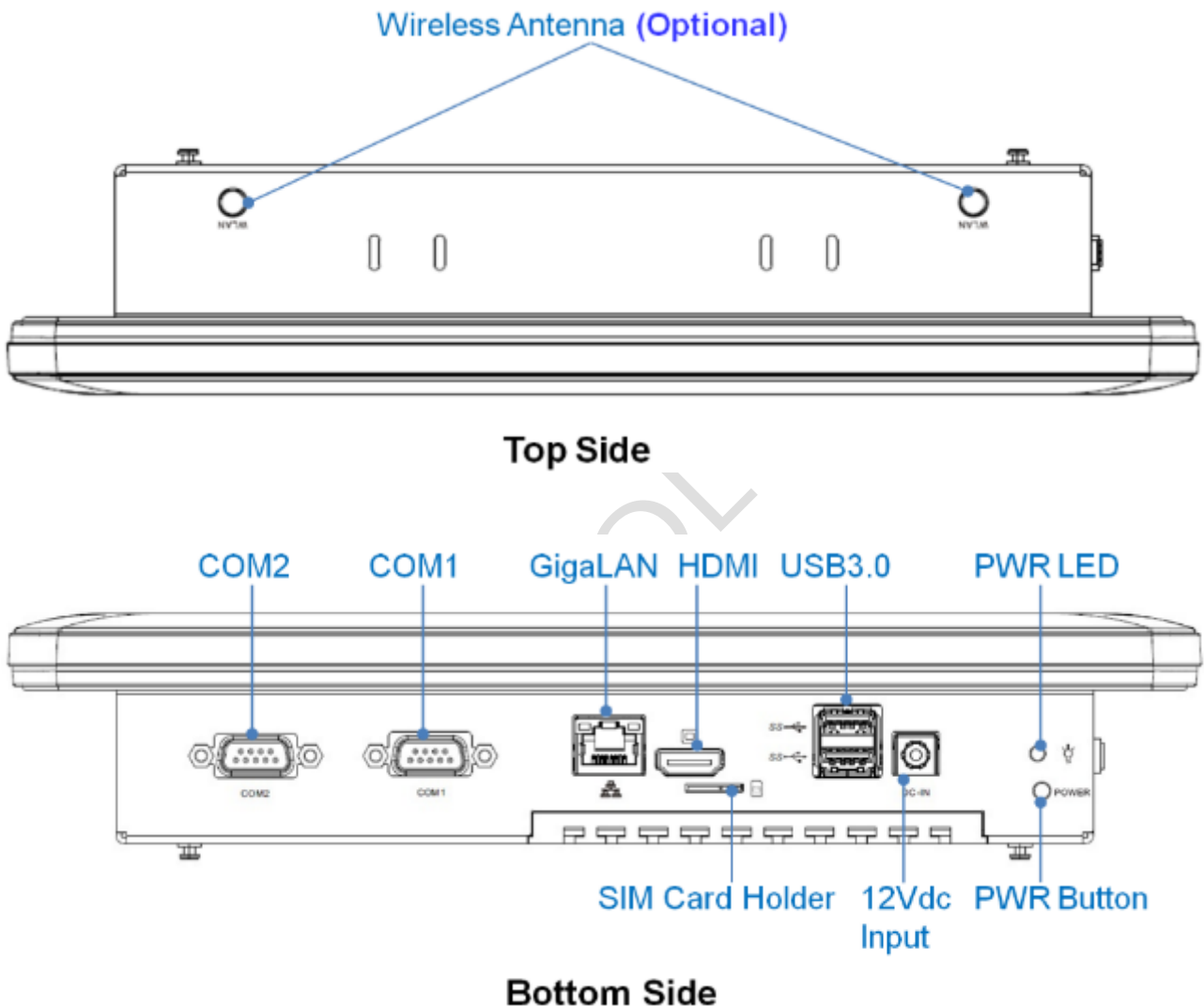

NOTE: COM1 RS232/422/485 is selected by BIOS setting. Please refer the section, 4.6 to set the function in the BIOS setup.

Left Side

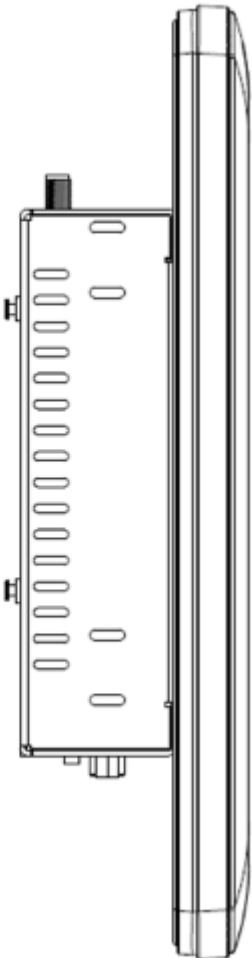

Right Side

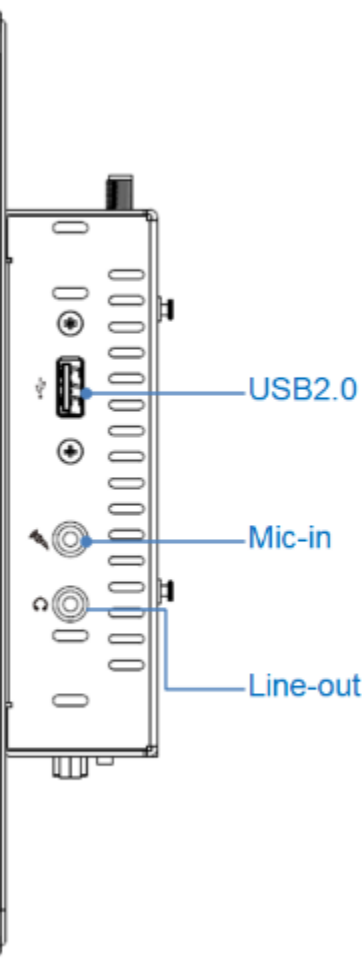

ICOP TEC

2.5 External I/O Pin Assignment

Power DC Jack (12Vdc Input)

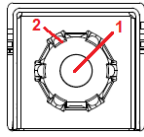
	Pin #	Signal Name
	1	+12Vdc
	2	GND

COM1 (RS232/422/485)

(Change mode by BIOS Setup)

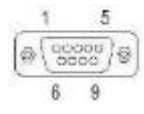
	Pin #	Signal Name	Pin #	Signal Name
	1	DCD1 /422TX- /RS485-	2	RXD1 /422TX+ /RS485+
	3	TXD1 /422RX+	4	DTR1 /422RX-
	5	GND	6	DSR1
	7	RTS1	8	CTS1
	9	RI1		

COM2 (RS232)

	Pin #	Signal Name	Pin #	Signal Name
	1	DCD2	2	RXD2
	3	TXD2	4	DTR2
	5	GND	6	DSR2
	7	RTS2	8	CTS2
	9	RI2		

GigaLAN

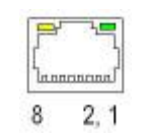
	Pin #	Signal Name	Pin #	Signal Name
	1	TP0+	2	TP0-
	3	TP1+	4	TP2+
	5	TP2-	6	TP1-
	7	TP3+	8	TP3-

HDMI

	Pin #	Signal Name
	1	TMDS_Data2+
	2	TMDS_Data2_Shield
	3	TMDS_Data2-
	4	TMDS_Data1+
	5	TMDS_Data1_Shield
	6	TMDS_Data1-
	7	TMDS_Data0+
	8	TMDS_Data0_Shield
	9	TMDS_Data0-
	10	TMDS_CLK+
	11	TMDS_CLK_Shield
	12	TMDS_CLK-
	13	CEC
	14	Reserved
	15	SCL
	16	SDA
	17	DDC/CEC_GND
	18	+5V Power
	19	Hop_Plug_Detect

SIM Card Holder (Micro SIM Card Support)

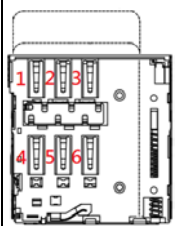
	Pin #	Signal Name	Pin #	Signal Name
	1	SIM-VCC	2	SIM-RST
	3	SIM-CLK	4	GND
	5	SIM-VPP	6	SIM-IO

USB2.0

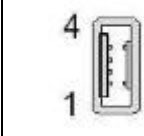
	Pin #	Signal Name
	1	VCC
	2	USB0-
	3	USB0+
	4	GND

Line-Out

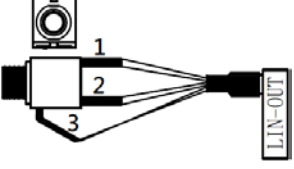
	Pin #	Signal Name
	1	LINEOUT2-L
	2	LINEOUT2-R
	3	AUDIO_GND

Mic-in

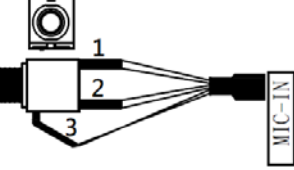
	Pin #	Signal Name
	1	MIC-L
	2	MIC-R
	3	AUDIO_GND

Ch. 3

Hardware Installation

PPC-090T-APL supports various kinds of storages for industrial application, divided into M.2 2242 SATA (M-Key) and 2.5" SATAIII HDD/SSD.

[3.1 Installing the M.2 2242 SATA](#)

[3.2 Installing the 2.5" SATA HDD/SSD](#)

[3.3 Installing the Mini-PCIe Module](#)

[3.4 Installing the Micro SIM Card \(Must include 3G/4G Mini-PCIe Module in advance\)](#)

3.1 Installing the M.2 2242 SATA

[SPEC]

Standard M.2 2242 form factor
22 x 42 x 3.2 mm



[M.2 2242 SATA LIST]

P/N	MLC	Operating Temperature
IM242S-8G-M	V	0°C ~ +70°C
IM242S-16G-M	V	0°C ~ +70°C
IM242S-32G-M	V	0°C ~ +70°C
IM242S-64G-M	V	0°C ~ +70°C
IM242S-128G-M	V	0°C ~ +70°C
IM242S-256G-M	V	0°C ~ +70°C

[STEP]

1. Remove the 4 screws as the image below.

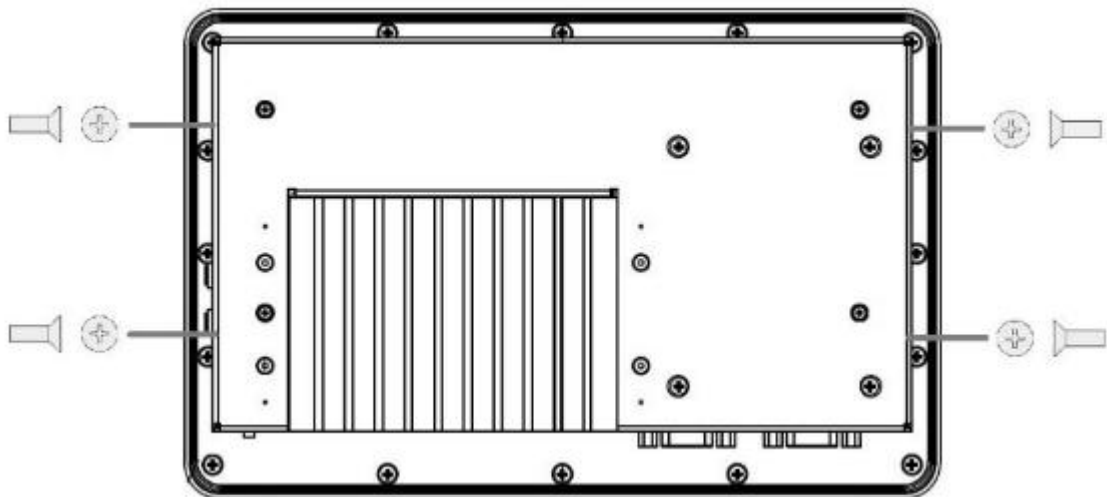

2. Pull up rear cover carefully, which LCD, Backlight and Touch cables inside the rear cover and please be careful to open it.

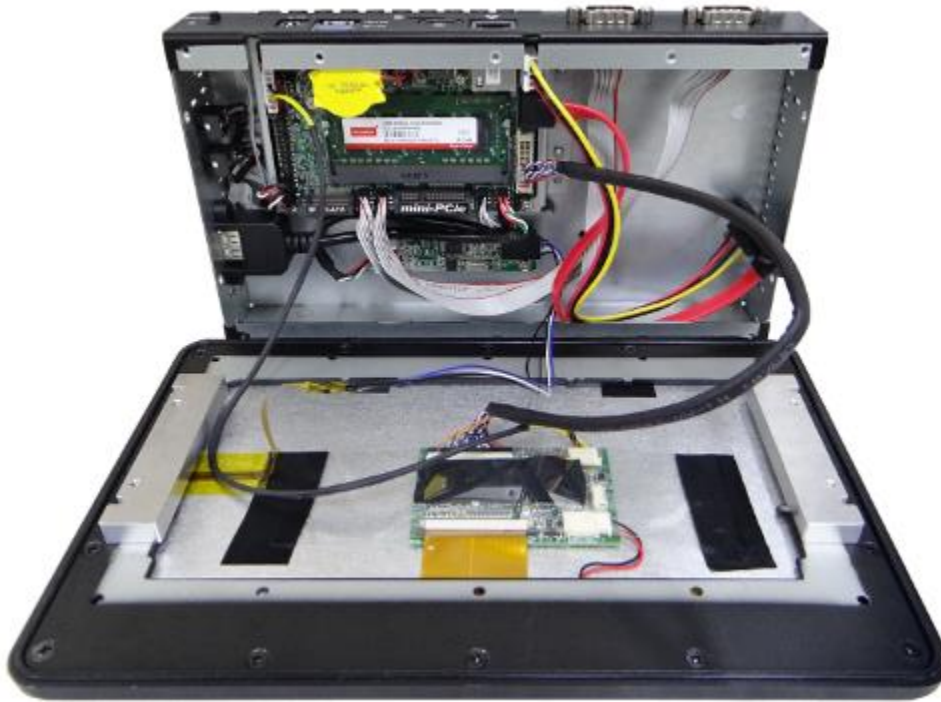

3. Remove the screw of M.2 Slot.



4. Plug M.2 2242 Storage on M.2 Slot and lock the screw.



5. Take the rear cover back and lock 4 screws.

3.2 Installing the 2.5” SATA HDD/SDD

[STEP]

1. Find the bag of screws from inside of the package box, and prepare those 4 screws in advance.



2. Remove the 4 screws as the image below.

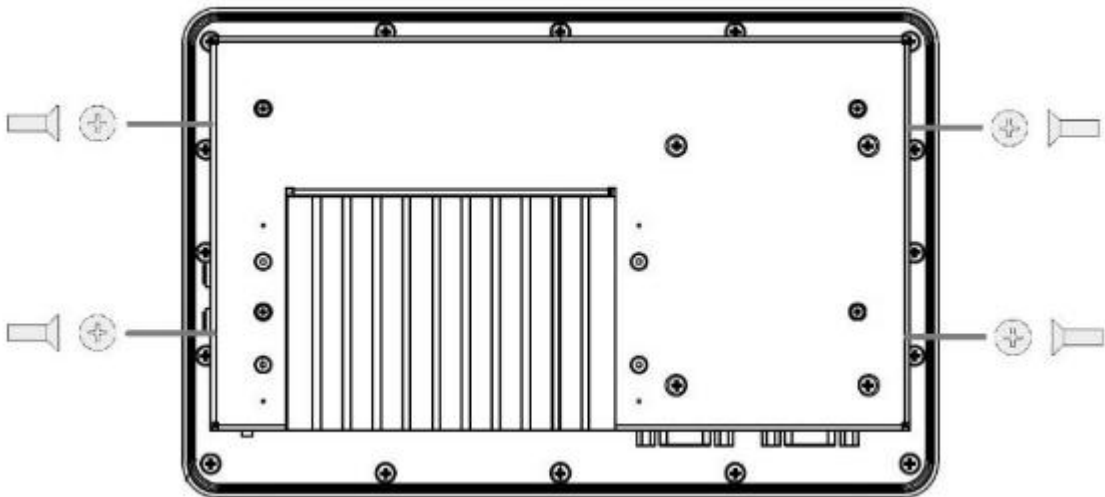

3. Pull up rear cover carefully, which LCD, Backlight and Touch cables inside the

rear cover and please be careful to open it.

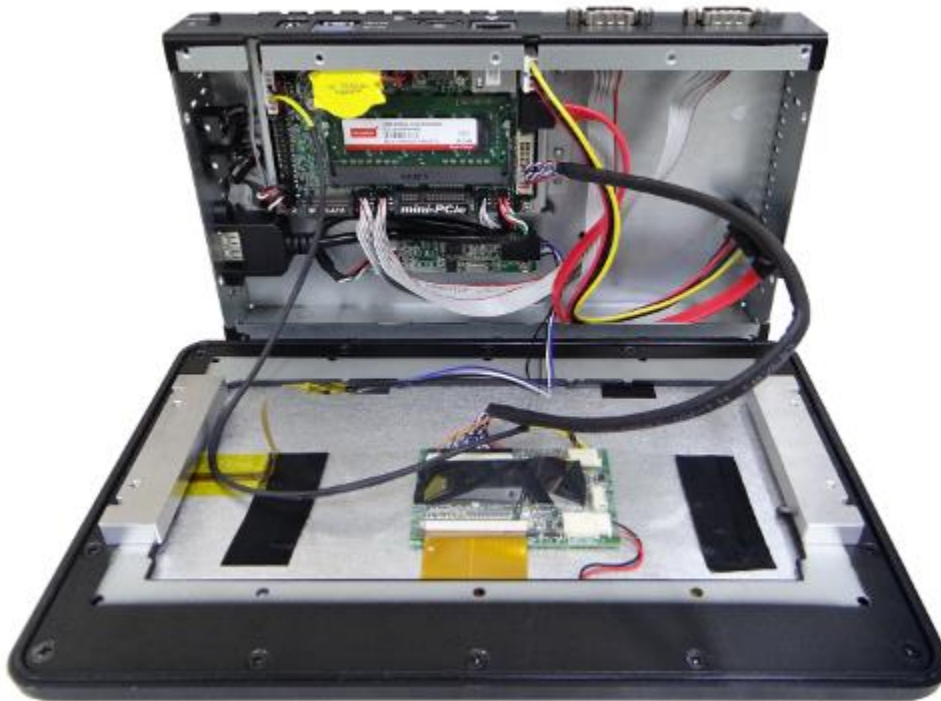

4. Plug SATA cable upon 2.5" SATA HDD/SSD and take it in the box.



5. Lock the screws on the both of rear cover and 2.5" HDD/SSD.

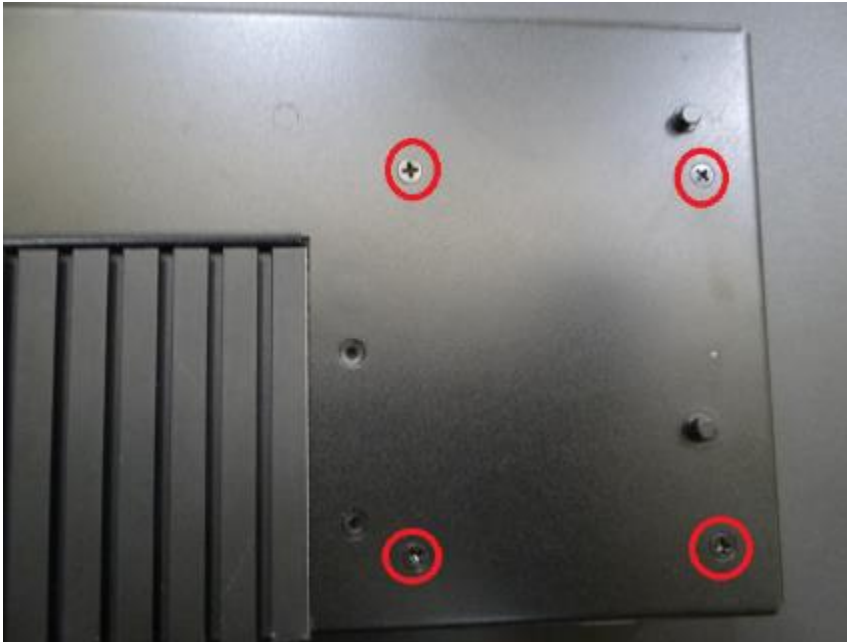

6. Take the rear cover back and lock 4 screws.

3.3 Installing the Mini-PCle Module

[STEP]

1. Remove the 4 screws as the image below.

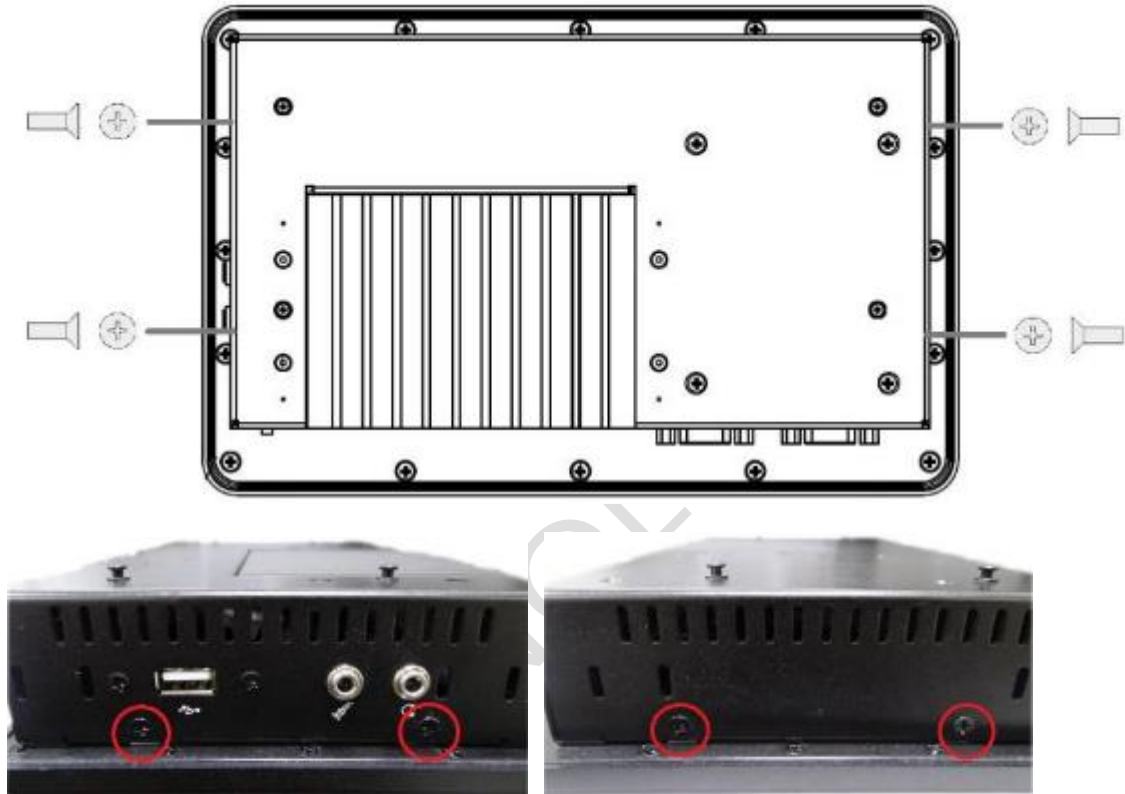

2. Pull up rear cover carefully, which LCD, Backlight and Touch cables inside the rear cover and please be careful to open it.



3. Remove the screw of Mini-PCle Slot.



4. Plug Mini-PCle Module upon the slot and lock the screws.
5. Take the rear cover back and lock 4 screws.

3.4 Installing the Micro SIM Card (Must include 3G/4G Mini-PCle Module in advance)

[STEP]

1. Please refer the section, 3.3 to install 3G/4G Mini-PCle Module in advance.
2. Plug Micro SIM Card on the slot.

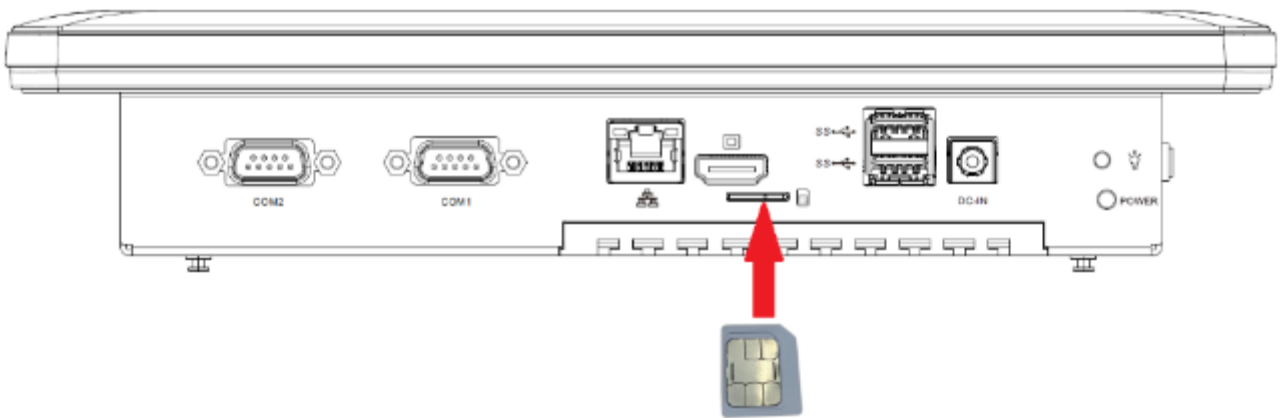

Ch. 4

Drivers and BIOS Instruction

[4.1 Operating System Support and Drivers](#)

[4.2 BIOS Hot Key](#)

[4.3 BIOS COM1 Setting \(RS232/RS422/RS485\)](#)

[4.4 BIOS COM2 Setting \(Change Settings\)](#)

[4.5 BIOS AT Mode Setting \(Support Auto-Power On Function\)](#)

[4.6 BIOS Serial Port Console Redirection](#)

[4.7 BIOS Load Default Setting](#)

4.1 Operating System Support and Drivers

The PPC-090T-APL provides the Win10 drivers for Normal Win10 and Win10 IoT Enterprise.

Please get the drivers from ICOP technical support URL:

https://www.icop.com.tw/download_resource/PPC-090T-N4200?tags=18,81,34,35,38,39,64,65&selected=35

For Linux, most Linux distributions support Intel® Apollo Lake Processor and user can install Linux upon PPC-090T-APL directly. Please contact your region sales for technical support if you have any question.

4.2 BIOS Hot Key

After power on, it supports BIOS hot key as below.



Press < **Del** > to enter the AMI BIOS setup



Press < **F7** > to enter Popup Menu

ICOP TECHNOLOGY INC.

4.3 BIOS COM1 Setting (RS232/422/485)

COM1 can be set to be RS232/422/485 function. Please refer the instruction as below.

(1) In the BIOS Setup, please go to “Advanced” and “Super IO Configuration”.

```
Aptio Setup Utility - Copyright (C) 2019 American Megatrends, Inc.
Main  Advanced  Chipset  Security  Boot  Save & Exit

OS Selection          [Windows]
|> Trusted Computing
|> ACPI Settings
|> Super IO Configuration
|> Serial Port Console Redirection
|> PC Health Status
|> CPU Configuration
|> Network Stack Configuration
|> CSM Configuration
|> Wake-up Function Settings
|> USB Configuration

|> Realtek PCIe GBE Family Controller
    (MAC:00:30:18:0F:95:29)

System Super IO
Parameters.

-><: Select Screen
^v: Select Item
Enter: Select
+/-: Change Opt.
F1: General Help
F2: Previous Values
F3: Optimized Defaults
F4: Save & Exit
ESC: Exit

Version 2.18.1263. Copyright (C) 2019 American Megatrends, Inc.
```

(2) Go to “Serial Port 1 Configuration”.

```
Aptio Setup Utility - Copyright (C) 2019 American Megatrends, Inc.
Advanced

Super IO Configuration
|> Serial Port 1 Configuration
|> Serial Port 2 Configuration

ERP Support          [Disabled]

WatchDog Reset Timer [Disabled]
WatchDog Wake-up    [Disabled]
Timer

ATX Power Emulate AT -Disabled-
Power

Set Parameters of
Serial Port 1 (COMA)

-><: Select Screen
^v: Select Item
Enter: Select
+/-: Change Opt.
F1: General Help
F2: Previous Values
F3: Optimized Defaults
F4: Save & Exit
ESC: Exit

Version 2.18.1263. Copyright (C) 2019 American Megatrends, Inc.
```

(3) Go to Transmission Mode and set RS232/422/485 function.

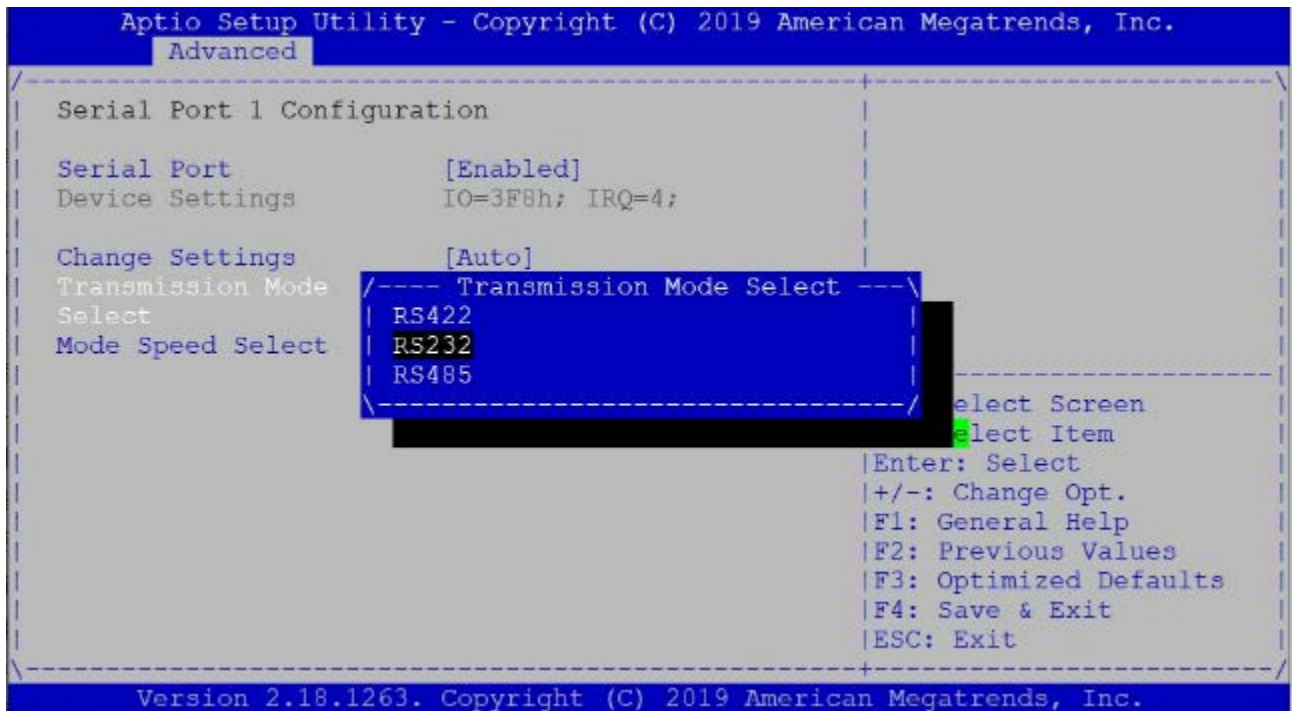

(4) After setting, please press "F4" key to save & exit.

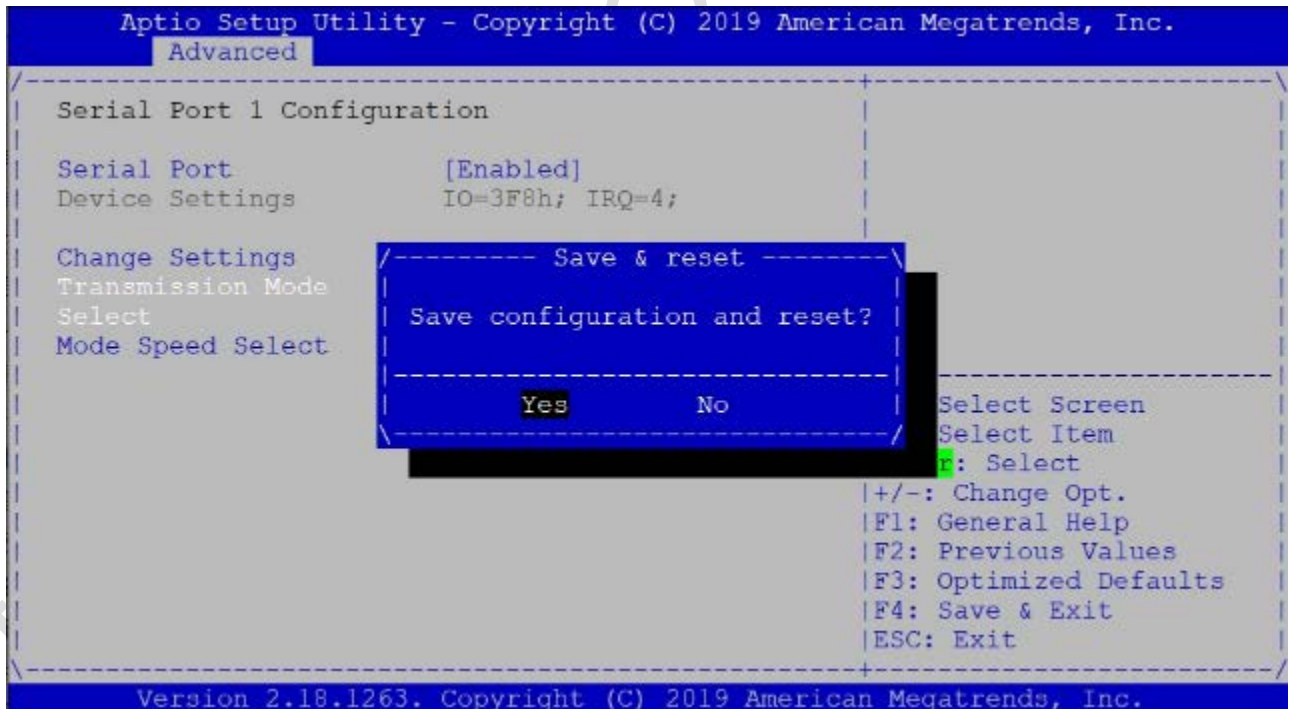

4.4 BIOS COM2 Setting (Change Settings)

COM2 can be changed settings as below.

(1) In the BIOS Setup, please go to “Advanced” and “Super IO Configuration”.

```
Aptio Setup Utility - Copyright (C) 2019 American Megatrends, Inc.
Main Advanced Chipset Security Boot Save & Exit
-----
| OS Selection [Windows] | System Super IO Parameters. |
|> Trusted Computing | |
|> ACPI Settings | |
|> Super IO Configuration | |
|> Serial Port Console Redirection | |
|> PC Health Status | |
|> CPU Configuration | |
|> Network Stack Configuration | |
|> CSM Configuration | |
|> Wake-up Function Settings |><: Select Screen |
|> USB Configuration | ^v: Select Item |
| | Enter: Select |
|> Realtek PCIe GBE Family Controller | +/-: Change Opt. |
| (MAC:00:30:18:0F:95:29) | F1: General Help |
| | F2: Previous Values |
| | F3: Optimized Defaults |
| | F4: Save & Exit |
| | ESC: Exit |
-----
Version 2.18.1263. Copyright (C) 2019 American Megatrends, Inc.
```

(2) Go to “Serial Port 2 Configuration”.

```
Aptio Setup Utility - Copyright (C) 2019 American Megatrends, Inc.
Advanced
-----
| Super IO Configuration | Set Parameters of |
| | Serial Port 2 (COMB) |
|> Serial Port 1 Configuration | |
|> Serial Port 2 Configuration | |
| ERP Support [Disabled] | |
| WatchDog Reset Timer [Disabled] | |
| WatchDog Wake-up [Disabled] | |
| Timer | |
| ATX Power Emulate AT -Disabled- | |
| Power | |
| |><: Select Screen |
| | ^v: Select Item |
| | Enter: Select |
| | +/-: Change Opt. |
| | F1: General Help |
| | F2: Previous Values |
| | F3: Optimized Defaults |
| | F4: Save & Exit |
| | ESC: Exit |
-----
Version 2.18.1263. Copyright (C) 2019 American Megatrends, Inc.
```

- (3) Go to “Change Settings” and set IO address and IRQ if you want to have the default, IO=2F8h and IRQ=3.

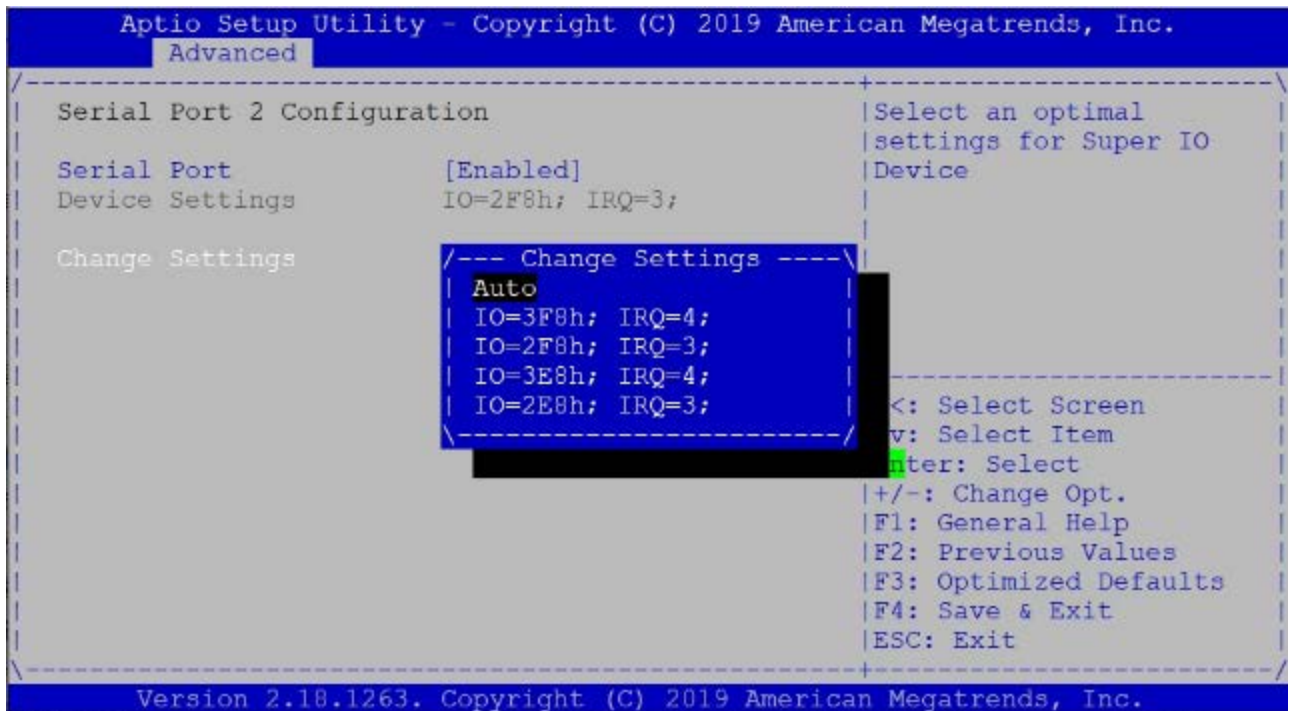

- (4) After setting, please press “F4” key to save & exit.

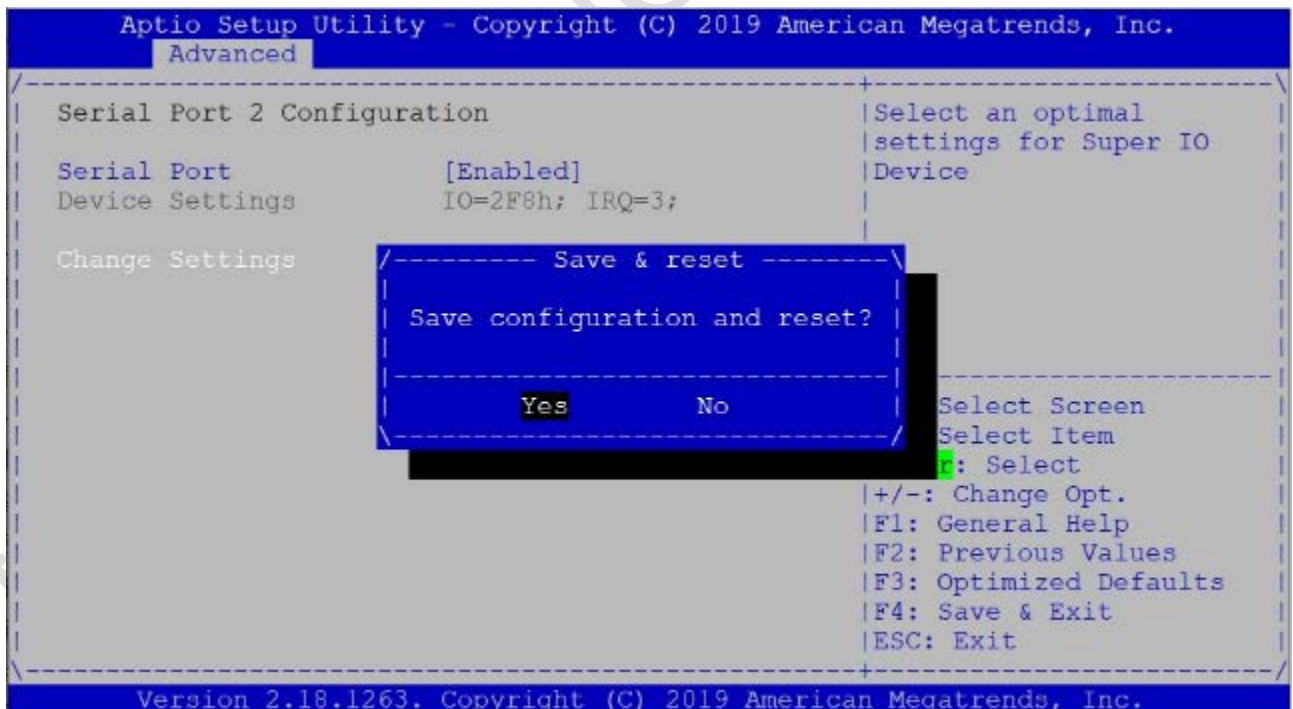

4.5 BIOS AT Mode Setting (Support Auto-Power On Function)

PPC-090T-APL supports “Auto-Power On function”, user doesn’t need to press “power button” for system power on and just needs to plug power source input and system will be power on automatically.

(1) In the BIOS Setup, please go to “Chipset” and “South Cluster Configuration”.

```
Aptio Setup Utility - Copyright (C) 2019 American Megatrends, Inc.
Main  Advanced  Chipset  Security  Boot  Save & Exit

|> Uncore Configuration
|> South Cluster Configuration

|South Cluster Configuration|

|><: Select Screen
|^v: Select Item
|Enter: Select
|+/-: Change Opt.
|F1: General Help
|F2: Previous Values
|F3: Optimized Defaults
|F4: Save & Exit
|ESC: Exit

Version 2.18.1263. Copyright (C) 2019 American Megatrends, Inc.
```

(2) Set “System State after Power Failure” to be “Always On”.

```
Aptio Setup Utility - Copyright (C) 2019 American Megatrends, Inc.
Chipset

|> PCI Express Configuration
|> SATA Configuration

|HD-Audio Support [Enabled]|
|System State after [Always Off]|
|Power Failure|

|---- System State after Power Failure ----|
|Always On|
|Always Off|
|Former State|

|Specify what state to go to when power is re-applied after a power failure.

|> Select Screen
|^v: Select Item
|Enter: Select
|+/-: Change Opt.
|F1: General Help
|F2: Previous Values
|F3: Optimized Defaults
|F4: Save & Exit
|ESC: Exit

Version 2.18.1263. Copyright (C) 2019 American Megatrends, Inc.
```

(3) After setting, please press “F4” key to save & exit.

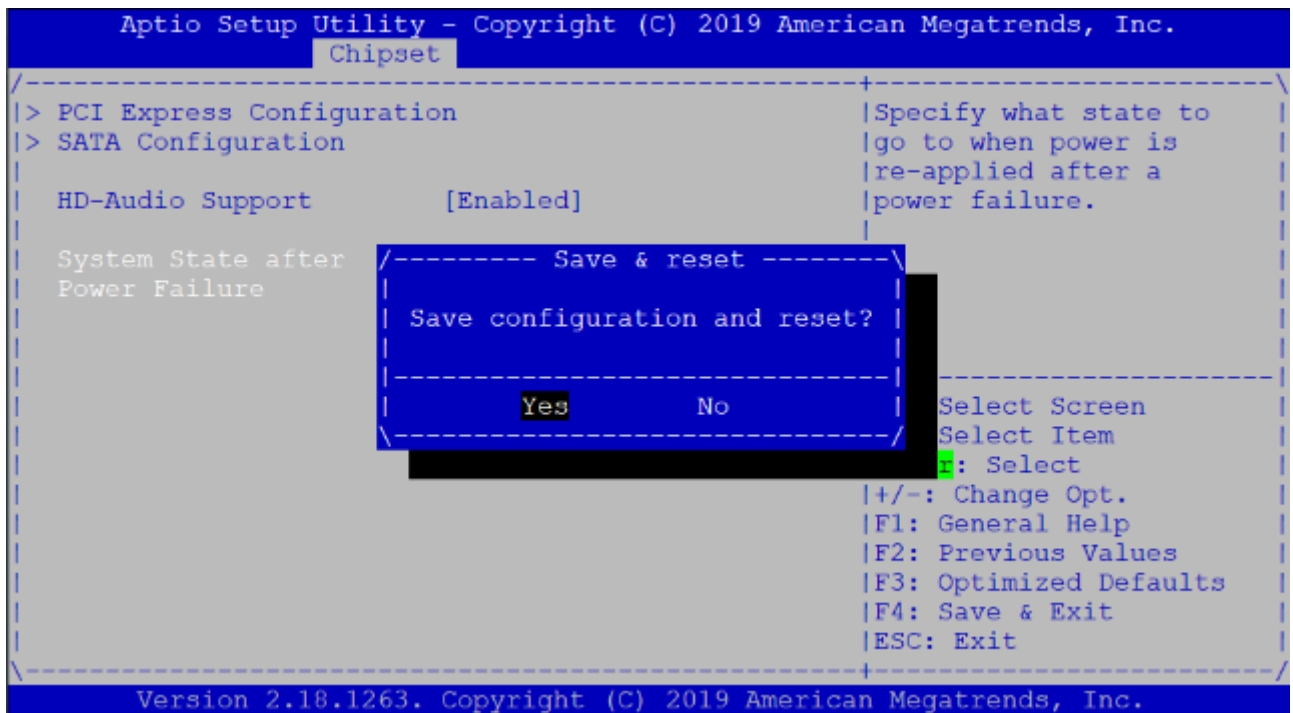

Note:

After system shut down by operating system, PPC-090T-APL will be power-off. For next booting up, user just needs to re-plug power adapter or power reset again, while system will be boot-up automatically.

4.6 BIOS Serial Port Console Redirection

PPC-090T-APL supports Serial Port Console Redirection as below.

(1) Go to “Advanced” and “Serial Port Console Redirection”.

```
Aptio Setup Utility - Copyright (C) 2019 American Megatrends, Inc.
Main  Advanced  Chipset  Security  Boot  Save & Exit

OS Selection          [Windows]
Serial Port Console Redirection

|> Trusted Computing
|> ACPI Settings
|> Super IO Configuration
|> Serial Port Console Redirection
|> PC Health Status
|> CPU Configuration
|> Network Stack Configuration
|> CSM Configuration
|> Wake-up Function Settings
|> USB Configuration

|> Realtek PCIe GBE Family Controller
    (MAC:00:30:18:0F:95:29)

|><: Select Screen
|^v: Select Item
|Enter: Select
|+/-: Change Opt.
|F1: General Help
|F2: Previous Values
|F3: Optimized Defaults
|F4: Save & Exit
|ESC: Exit

Version 2.18.1263. Copyright (C) 2019 American Megatrends, Inc.
```

(2) Set “Console Redirection” to be “Enabled”.

```
Aptio Setup Utility - Copyright (C) 2019 American Megatrends, Inc.
Advanced

COM1
Console Redirection  [Enabled]
|> Console Redirection Settings

Serial Port for Out-of-Band Management/
Windows Emergency Management Services (EMS)
Console Redirection  [Disabled]
|> Console Redirection Settings

|><: Select Screen
|^v: Select Item
|Enter: Select
|+/-: Change Opt.
|F1: General Help
|F2: Previous Values
|F3: Optimized Defaults
|F4: Save & Exit
|ESC: Exit

Version 2.18.1263. Copyright (C) 2019 American Megatrends, Inc.
```

(3) Set "Terminal Type" to "VT100+".

Emulation: [ANSI]: Extended ASCII char set; [VT100]: ASCII char set;

[VT100+]: Extended VT100 to support color, function keys, etc.;

[VT-UTF8]: Uses UTF8 encoding to map Unicode chars onto 1 or more

Bytes.

```
Aptio Setup Utility - Copyright (C) 2019 American Megatrends, Inc.
  Advanced
-----
COM1                               ^| Emulation: ANSI:
Console Redirection Settings       *| Extended ASCII char
Terminal Type                       *| set. VT100: ASCII char
      [VT100+]                     *| set. VT100+: Extends
Bits per second                    *| VT100 to support color,
      [115200]                     *| function keys, etc.
Data Bits                          *| VT-UTF8: Uses UTF8
      [8]                          *| encoding to map Unicode
Parity                             *|
      [None]                       *|
Stop Bits                          *|
      [1]                          *|
Flow Control                       *|
      [None]                       *|
VT-UTF8 Combo Key                  *|
Support                            *|<
      [Enabled]                    *|>X: Select Screen
Recorder Mode                      *| ^v: Select Item
      [Disabled]                   *| Enter: Select
Resolution 100x31                  *| +/-: Change Opt.
      [Disabled]                   *| F1: General Help
Legacy OS                          *| F2: Previous Values
      [80x24]                      *| F3: Optimized Defaults
Redirection                        +| F4: Save & Exit
Resolution                          v| ESC: Exit
Putty KeyPad                       |
      [VT100]                      |
-----
Version 2.18.1263. Copyright (C) 2019 American Megatrends, Inc.
```

(4) After setting, please press "F4" key to save & exit.

```
Aptio Setup Utility - Copyright (C) 2019 American Megatrends, Inc.
  Advanced
-----
COM1                               ^| Emulation: ANSI:
Console Redirection Settings       *| Extended ASCII char
Terminal Type                       *| set. VT100: ASCII char
      [VT100+]                     *| set. VT100+: Extends
Bits per second                    *| VT100 to support color,
      [115200]                     *| function keys, etc.
Data Bits                          *| VT-UTF8: Uses UTF8
      [8]                          *| encoding to map Unicode
Parity                             *|
      [None]                       *|
Stop Bits                          *|
      [1]                          *|
Flow Control                       *|
      [None]                       *|
VT-UTF8 Combo Key                  *|
Support                            *|<
      [Enabled]                    *|>X: Select Screen
Recorder Mode                      *| ^v: Select Item
      [Disabled]                   *| Enter: Select
Resolution 100x31                  *| +/-: Change Opt.
      [Disabled]                   *| F1: General Help
Legacy OS                          *| F2: Previous Values
      [80x24]                      *| F3: Optimized Defaults
Redirection                        +| F4: Save & Exit
Resolution                          v| ESC: Exit
Putty KeyPad                       |
      [VT100]                      |
-----
Version 2.18.1263. Copyright (C) 2019 American Megatrends, Inc.
```

Save & reset
Save configuration and reset?
Yes No

4.7 BIOS Load Default Setting

(1) Press “F3” key to load optimized defaults.

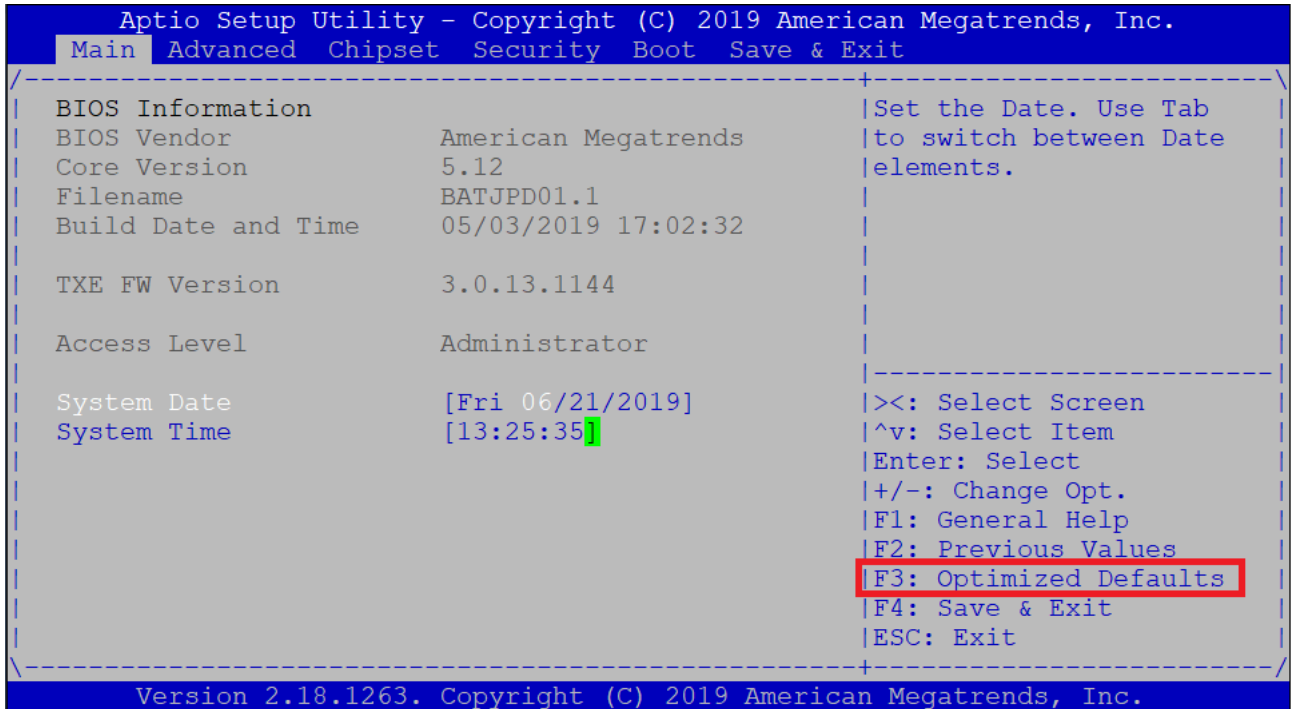

(2) After setting, please press “F4” key to save & exit.

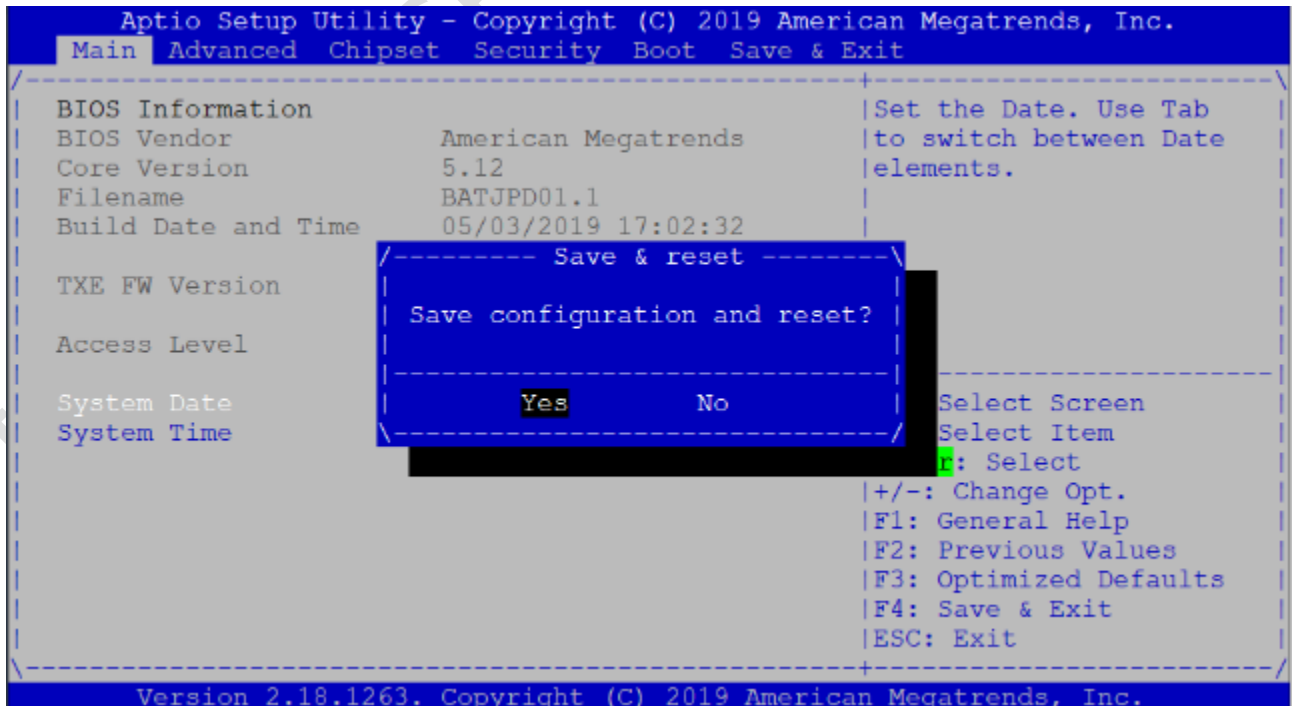

Warranty

This product is warranted to be in good working order for a period of one year from the date of purchase. Should this product fail to be in good working order at any time during this period, we will, at our option, replace or repair it at no additional charge except as set forth in the following terms. This warranty does not apply to products damaged by misuse, modifications, accident or disaster. Vendor assumes no liability for any damages, lost profits, lost savings or any other incidental or consequential damage resulting from the use, misuse of, originality to use this product. Vendor will not be liable for any claim made by any other related party. Return authorization must be obtained from the vendor before returned merchandise will be accepted. Authorization can be obtained by calling or faxing the vendor and requesting a Return Merchandise Authorization (RMA) number. Returned goods should always be accompanied by a clear problem description.

All Trademarks appearing in this manuscript are registered trademark of their respective owners. All Specifications are subject to change without notice.
©ICOP Technology Inc. 2021