



NEXCOM International Co., Ltd.

Intelligent Platform & Services Business Unit

Digital Signage Platform

NDiS B561

User Manual

CONTENTS

Preface

Copyright	iv
Disclaimer	iv
Acknowledgements	iv
Regulatory Compliance Statements	iv
Declaration of Conformity	iv
RoHS Compliance	v
Warranty and RMA	vi
Safety Information	viii
Installation Recommendations	viii
Safety Precautions	ix
Technical Support and Assistance	x
Conventions Used in this Manual	x
Global Service Contact Information	xi
Package Contents	xiii
Ordering Information	xiv

Chapter 1: Product Introduction

Overview	1
Key Features	1
Physical Features	2
Front Panel	2
Rear Panel	2
Hardware Specifications	3
Mechanical Dimensions	5

Chapter 2: Jumpers and Connectors

Before You Begin	6
Precautions	6
Locations of the Jumpers and Connectors for NDiB B561	7
Top View	7
Bottom View	8
Jumper Settings	9
Jumper Settings	10
AT/ATX Mode Selection	10
CMOS Clear Selection	10
Connector Pin Definitions	11
External I/O Interfaces	11
COM Ports	11
DC Input (+12~24V)	11
HDMI Connector	12
HDMI Connectors	13
LAN Ports	14
Power Button	15
Reset Button	15
USB Ports	16
Internal Connectors	17
ATX +12V Power Connector	17
Battery Connector	17
Fan Connectors	18
GPIO Connector	18

MIC-In LINE-Out Connector.....	19
M.2 Key B 3042/3052 Slot.....	20
M.2 Key E 2230 Slot.....	21
M.2 Key M 2280 Slot.....	22
SATA Connectors.....	23
SATA Power Connectors.....	23
SMBus/I2C Connector.....	24
Speaker Connector.....	24
USB 2.0 Connectors.....	25
LED Indicators.....	26
LAN Port LEDs.....	26
Status Indicators.....	26
Block Diagram.....	27

Chapter 3: System Setup

Removing the Chassis Cover.....	28
Installing a CPU.....	30
Installing a SO-DIMM (DIMM1).....	33
Installing a SO-DIMM (DIMM2).....	34
Installing a M.2 Storage Module (M2M1).....	35
Installing a M.2 Storage Module (M2M2).....	36
Installing a M.2 WiFi Module.....	37
(Key E 2230).....	37
Installing a M.2 Mobile Network Module.....	39
(Key B 3042/3052).....	39

Chapter 4: BIOS Setup

About BIOS Setup.....	50
When to Configure the BIOS.....	50
Default Configuration.....	51
Entering Setup.....	51
Legends.....	51
BIOS Setup Utility.....	53
Main.....	53
Advanced.....	54
Security.....	63
Boot.....	63
Save & Exit.....	64

Appendix A: NCT6126D GPI/O Programming Guide (PCB A)

GPIO programming sample code.....	76
-----------------------------------	----

Appendix B: NCT6126D WatchDog Programming Guide

PREFACE

Copyright

This publication, including all photographs, illustrations and software, is protected under international copyright laws, with all rights reserved. No part of this manual may be reproduced, copied, translated or transmitted in any form or by any means without the prior written consent from NEXCOM International Co., Ltd.

Disclaimer

The information in this document is subject to change without prior notice and does not represent commitment from NEXCOM International Co., Ltd. However, users may update their knowledge of any product in use by constantly checking its manual posted on our website: <http://www.nexcom.com>. NEXCOM shall not be liable for direct, indirect, special, incidental, or consequential damages arising out of the use of any product, nor for any infringements upon the rights of third parties, which may result from such use. Any implied warranties of merchantability or fitness for any particular purpose is also disclaimed.

Acknowledgements

NDiS B561 is a trademark of NEXCOM International Co., Ltd. All other product names mentioned herein are registered trademarks of their respective owners.

Regulatory Compliance Statements

This section provides the FCC compliance statement for Class B devices and describes how to keep the system CE compliant.

Declaration of Conformity

FCC

This equipment has been tested and verified to comply with the limits for a Class B digital device, pursuant to Part 15 of FCC Rules. These limits are designed to provide reasonable protection against harmful interference when the equipment is operated in a commercial environment. This equipment generates, uses, and can radiate radio frequency energy and, if not installed and used in accordance with the instructions, may cause harmful interference to radio communications. Operation of this equipment in a residential area (domestic environment) is likely to cause harmful interference, in which case the user will be required to correct the interference (take adequate measures) at their own expense.

CE

The product(s) described in this manual complies with all applicable European Union (CE) directives if it has a CE marking. For computer systems to remain CE compliant, only CE-compliant parts may be used. Maintaining CE compliance also requires proper cable and cabling techniques.

RoHS Compliance



NEXCOM RoHS Environmental Policy and Status Update

NEXCOM is a global citizen for building the digital infrastructure. We are committed to providing green products and services, which are compliant with European Union RoHS (Restriction on Use of Hazardous Substance in Electronic Equipment) directive 2011/65/EU, to be your trusted green partner and to protect our environment.

RoHS restricts the use of Lead (Pb) < 0.1% or 1,000ppm, Mercury (Hg) < 0.1% or 1,000ppm, Cadmium (Cd) < 0.01% or 100ppm, Hexavalent Chromium (Cr6+) < 0.1% or 1,000ppm, Polybrominated biphenyls (PBB) < 0.1% or 1,000ppm, and Polybrominated diphenyl Ethers (PBDE) < 0.1% or 1,000ppm.

In order to meet the RoHS compliant directives, NEXCOM has established an engineering and manufacturing task force to implement the introduction of green products. The task force will ensure that we follow the standard NEXCOM development procedure and that all the new RoHS components and new manufacturing processes maintain the highest industry quality levels for which NEXCOM are renowned.

The model selection criteria will be based on market demand. Vendors and suppliers will ensure that all designed components will be RoHS compliant.

How to recognize NEXCOM RoHS Products?

For existing products where there are non-RoHS and RoHS versions, the suffix "(LF)" will be added to the compliant product name.

All new product models launched after January 2013 will be RoHS compliant. They will use the usual NEXCOM naming convention.

Warranty and RMA

NEXCOM Warranty Period

NEXCOM manufactures products that are new or equivalent to new in accordance with industry standard. NEXCOM warrants that products will be free from defect in material and workmanship for 2 years, beginning on the date of invoice by NEXCOM.

NEXCOM Return Merchandise Authorization (RMA)

- Customers shall enclose the “NEXCOM RMA Service Form” with the returned packages.
- Customers must collect all the information about the problems encountered and note anything abnormal or, print out any on-screen messages, and describe the problems on the “NEXCOM RMA Service Form” for the RMA number apply process.
- Customers can send back the faulty products with or without accessories (manuals, cable, etc.) and any components from the card, such as CPU and RAM. If the components were suspected as part of the problems, please note clearly which components are included. Otherwise, NEXCOM is not responsible for the devices/parts.
- Customers are responsible for the safe packaging of defective products, making sure it is durable enough to be resistant against further damage and deterioration during transportation. In case of damages occurred during transportation, the repair is treated as “Out of Warranty.”
- Any products returned by NEXCOM to other locations besides the customers’ site will bear an extra charge and will be billed to the customer.

Repair Service Charges for Out-of-Warranty Products

NEXCOM will charge for out-of-warranty products in two categories, one is basic diagnostic fee and another is component (product) fee.

System Level

- Component fee: NEXCOM will only charge for main components such as SMD chip, BGA chip, etc. Passive components will be repaired for free, ex: resistor, capacitor.
- Items will be replaced with NEXCOM products if the original one cannot be repaired. Ex: motherboard, power supply, etc.
- Replace with 3rd party products if needed.
- If RMA goods can not be repaired, NEXCOM will return it to the customer without any charge.

Board Level

- Component fee: NEXCOM will only charge for main components, such as SMD chip, BGA chip, etc. Passive components will be repaired for free, ex: resistors, capacitors.
- If RMA goods can not be repaired, NEXCOM will return it to the customer without any charge.

Warnings

Read and adhere to all warnings, cautions, and notices in this guide and the documentation supplied with the chassis, power supply, and accessory modules. If the instructions for the chassis and power supply are inconsistent with these instructions or the instructions for accessory modules, contact the supplier to find out how you can ensure that your computer meets safety and regulatory requirements.

Cautions

Electrostatic discharge (ESD) can damage system components. Do the described procedures only at an ESD workstation. If no such station is available, you can provide some ESD protection by wearing an antistatic wrist strap and attaching it to a metal part of the computer chassis.

Safety Information

Before installing and using the device, note the following precautions:

- Read all instructions carefully.
- Do not place the unit on an unstable surface, cart, or stand.
- Follow all warnings and cautions in this manual.
- When replacing parts, ensure that your service technician uses parts specified by the manufacturer.
- Avoid using the system near water, in direct sunlight, or near a heating device.
- The load of the system unit does not solely rely for support from the rackmounts located on the sides. Firm support from the bottom is highly necessary in order to provide balance stability.
- The computer is provided with a battery-powered real-time clock circuit. There is a danger of explosion if battery is incorrectly replaced. Replace only with the same or equivalent type recommended by the manufacturer. Discard used batteries according to the manufacturer's instructions.
- The instructions shall require connection of the equipment protective earthing conductor to the installation protective earthing conductor (for example, by means of a power cord connected to a socket-outlet with earthing connection).

Installation Recommendations

Ensure you have a stable, clean working environment. Dust and dirt can get into components and cause a malfunction. Use containers to keep small components separated.

Adequate lighting and proper tools can prevent you from accidentally damaging the internal components. Most of the procedures that follow require only a few simple tools, including the following:

- A Philips screwdriver
- A flat-tipped screwdriver
- A grounding strap
- An anti-static pad

Using your fingers can disconnect most of the connections. It is recommended that you do not use needle-nose pliers to disconnect connections as these can damage the soft metal or plastic parts of the connectors.

Safety Precautions

1. Read these safety instructions carefully.
2. Keep this User Manual for later reference.
3. Disconnect this equipment from any AC outlet before cleaning. Use a damp cloth. Do not use liquid or spray detergents for cleaning.
4. For plug-in equipment, the power outlet socket must be located near the equipment and must be easily accessible.
5. Keep this equipment away from humidity.
6. Put this equipment on a stable surface during installation. Dropping it or letting it fall may cause damage.
7. The openings on the enclosure are for air convection to protect the equipment from overheating. **DO NOT COVER THE OPENINGS.**
8. Make sure the voltage of the power source is correct before connecting the equipment to the power outlet.
9. Place the power cord in a way so that people will not step on it. Do not place anything on top of the power cord. Use a power cord that has been approved for use with the product and that it matches the voltage and current marked on the product's electrical range label. The voltage and current rating of the cord must be greater than the voltage and current rating marked on the product.
10. All cautions and warnings on the equipment should be noted.
11. If the equipment is not used for a long time, disconnect it from the power source to avoid damage by transient overvoltage.
12. Never pour any liquid into an opening. This may cause fire or electrical shock.
13. This equipment is not suitable for use in locations where children are likely to be present.
14. Never open the equipment. For safety reasons, the equipment should be opened only by qualified service personnel.
15. If one of the following situations arises, get the equipment checked by service personnel:
 - a. The power cord or plug is damaged.
 - b. Liquid has penetrated into the equipment.
 - c. The equipment has been exposed to moisture.
 - d. The equipment does not work well, or you cannot get it to work according to the user's manual.
 - e. The equipment has been dropped and damaged.
 - f. The equipment has obvious signs of breakage.
16. Do not place heavy objects on the equipment.
17. The unit uses a three-wire ground cable which is equipped with a third pin to ground the unit and prevent electric shock. Do not defeat the purpose of this pin. If your outlet does not support this kind of plug, contact your electrician to replace your obsolete outlet.
18. **ATTENTION: Risque d'explosion si la batterie est remplacée par un type incorrect. Mettre au rebus les batteries usagées selon les instructions.**

CAUTION: Risk of explosion if battery is replaced by an incorrect type. Dispose of used batteries according to the instructions.
19. This product is intended to be supplied by a Listed (Certificate) power adapter, output rated 12Vdc, 8A or 8.33A minimum, Tma 40 degree C minimum and altitude 2000m. If further assistance is needed, please contact NEXCOM for further information.

Technical Support and Assistance

1. For the most updated information of NEXCOM products, visit NEXCOM's website at www.nexcom.com.
2. For technical issues that require contacting our technical support team or sales representative, please have the following information ready before calling:
 - Product name and serial number
 - Detailed information of the peripheral devices
 - Detailed information of the installed software (operating system, version, application software, etc.)
 - A complete description of the problem
 - The exact wordings of the error messages

Warning!

1. Handling the unit: carry the unit with both hands and handle it with care.
2. Maintenance: to keep the unit clean, use only approved cleaning products or clean with a dry cloth.
3. CompactFlash: Turn off the unit's power before inserting or removing a CompactFlash storage card.

Conventions Used in this Manual



Warning:

Information about certain situations, which if not observed, can cause personal injury. This will prevent injury to yourself when performing a task.



Caution:

Information to avoid damaging components or losing data.



Note:

Provides additional information to complete a task easily.

Global Service Contact Information

Headquarters

NEXCOM International Co., Ltd.

9F, No. 920, Zhongzheng Rd.,
Zhonghe District, New Taipei City, 23586,
Taiwan, R.O.C.
Tel: +886-2-8226-7786
Fax: +886-2-8226-7782
www.nexcom.com

Asia

Taiwan

NexAIoT Headquarters

Industry 4.0 and Cloud Services

13F, No.922, Zhongzheng Rd.,
Zhonghe District, New Taipei City,
23586, Taiwan, R.O.C.
Tel: +886-2-8226-7796
Fax: +886-2-8226-7926
Email: jacobhuang@nexaiot.com
www.nexaiot.com

NexAIoT Co., Ltd.

Taichung Office

16F, No.250, Sec.2, Chongde Rd.,
Beitun District,
Taichung City, 406, Taiwan, R.O.C.
Tel: +886-4-2249-1179
Fax: +886-4-2249-1172
Email: jacobhuang@nexaiot.com
www.nexaiot.com

NexCOBOT Taiwan Co., Ltd.

13F, No.916, Zhongzheng Rd.,
Zhonghe District,
New Taipei City, 23586, Taiwan, R.O.C.
Tel: +886-2-8226-7786
Fax: +886-2-8226-7926
Email: jennyshern@nexcobot.com
www.nexcobot.com

GreenBase Technology Corp.

13F, No.922, Zhongzheng Rd.,
Zhonghe District,
New Taipei City, 23586, Taiwan, R.O.C.
Tel: +886-2-8226-7786
Fax: +886-2-8226-7900
Email: vivianlin@nexcom.com.tw
www.nexcom.com.tw

DivioTec Inc.

19F-1A, No.97, Sec.4, ChongXin Rd.,
Sancong District,
New Taipei City, 24161, Taiwan, R.O.C.
Tel: +886-2-8976-3077
Email: sales@diviotec.com
www.diviotec.com

AIoT Cloud Corp.

13F, No.922, Zhongzheng Rd.,
Zhonghe District,
New Taipei City, 23586, Taiwan, R.O.C.
Tel: +886-2-8226-7786
Fax: +886-2-8226-7782
Email: alantsai@aiotcloud.net
www.aiotcloud.dev

EMBUX TECHNOLOGY CO., LTD.

13F, No.916, Zhongzheng Rd.,
Zhonghe District,
New Taipei City, 23586, Taiwan, R.O.C.
Tel: +886-2-8226-7786
Fax: +886-2-8226-7782
Email: info@embux.com
www.embux.com

TMR TECHNOLOGIES CO., LTD.

13F, No.916, Zhongzheng Rd.,
Zhonghe District,
New Taipei City, 23586, Taiwan, R.O.C.
Tel: +886-2-8226-7786
Fax: +886-2-8226-7782
Email: services@tmrtek.com
www.tmrtek.com

China NEXSEC Incorporated

201, Floor 2, Unit 2, Building 15, Yard 3,
Gaolizhang Road, Haidian District,
Beijing, 100094, China
Tel: +86-10-5704-2680
Fax: +86-10-5704-2681
Email: marketing@nexsec.cn
www.nexsec.cn

NEXCOM Shanghai

Room 406-407, Building C, No 154, Lane 953,
Jianchuan Road, Minhang District,
Shanghai, 201108, China
Tel: +86-21-5278-5868
Fax: +86-21-3251-6358
Email: sales@nexcom.cn
www.nexcom.cn

NEXCOM Surveillance Technology Corp.

Floor 8, Building B3, Xiufeng Industrial Zone,
GanKeng Community, Buji Street,
LongGang District,
ShenZhen, 518112, China
Tel: +86-755-8364-7768
Fax: +86-755-8364-7738
Email: steveyang@nexcom.com.tw
www.nexcom.cn

NEXGOL Chongqing

1st Building No.999,
Star Boulevard, Yongchuan Dist,
Chongqing City, 402160, China
Tel: +86-23-4960-9080
Fax: +86-23-4966-5855
Email: sales@nexgol.com.cn
www.nexcom.cn

Beijing NexGemo Technology Co.,Ltd.

Room 205, No.1, Fazhan Rd.,
Beijing International Information Industry Base,
Changping District,
Beijing, 102206, China
Tel: +86-10-8072-2025
Fax: +86-10-8072-2022
Email: sales@nexgemo.cn
www.nexgemo.com

Japan

NEXCOM Japan

9F, Tamachi Hara Bldg.,
4-11-5, Shiba Minato-ku,
Tokyo, 108-0014, Japan
Tel: +81-3-5419-7830
Fax: +81-3-5419-7832
Email: sales@nexcom-jp.com
www.nexcom-jp.com

America

USA NEXCOM USA

46665 Fremont Blvd.,
Fremont CA 94538, USA
Tel: +1-510-656-2248
Fax: +1-510-656-2158
Email: sales@nexcom.com
www.nexcomusa.com

Package Contents

Before continuing, verify that the NDiS B561 package that you received is complete. Your package should have all the items listed in the following table.

Item	Part Number	Name	Qty
1	19W00B56101X0	NDiS B561 System	1
2	7400120025X00	POWER ADAPTER FSP:FSP120-AHAN3	1
3	5060200706X00	60x20x2mm Thermal Pad apply to top side M.2 SSD	1
4	5060200638X00	70x20x1.5mm Thermal Pad apply to top side memory	1
5	5090000001X00	THERMAL GREASE apply to top of CPU	1
6	5060200725X00	60x20x3mm Thermal Pad apply to bottom side memory and M.2 SSD	2
7	5040430540X00	WALL MOUNT BRACKET	2
8	50311F0100X00	(H)ROUND HEAD SCREW W/SPRING+FLAT WASHER LONG FEI:P3x6L P3x6 iso/SW6x0.5 N	4

Ordering Information

The following information below provides ordering information for NDiS B561.

NDiS B561 (P/N: 10W00B56101X0)

12th Gen Intel® Core™ processor (up to 35W) fanless system, Intel® Q670E chipset.

CHAPTER 1: PRODUCT INTRODUCTION

Overview



Powered by the 12th Gen Intel® Core™ processor series and Intel® 600 series chipset integrated graphics controller, the NDiS B561 fanless visual edge computer can handle powerful multimedia content. It can be operated in an extended operating temperature range between -20 to 60°C. Moreover, to fully satisfy customers' expectations, there are three 4K2K independent display outputs or up to 8K@60Hz in one display output and rich connectives including 8 x USB 3.2, 3 x LAN ports (including 2 x PoE ports), Wi-Fi 6E and 4G, 5G support. The NDiS B561 can be used for both indoor and out-door applications such as visual edge computing, AI recognition, public transportation, outdoor bus station, and even smart stadium.

Key Features

- Support 12th Gen Intel® Core™ i9/i7/i5/i3 LGA socket type embedded processor, up to 35W
- Intel® Q670E
- Intel® integrated UHD graphic engine driven by Xe architecture
- Support 3 independent 4K2K@60Hz display output. HDMI 2.1 resolution can be up to 8K@60Hz
- 1 x HDMI 2.1, 2 x HDMI 2.0
- 8 x USB 3.2, 4 x COM,
- 1 x GbE LAN, 2 x 2.5G GbE LAN
- Support M.2 Key B/E/M
- Support extended temperature -20~60°C
- Fanless design

Physical Features

Front Panel

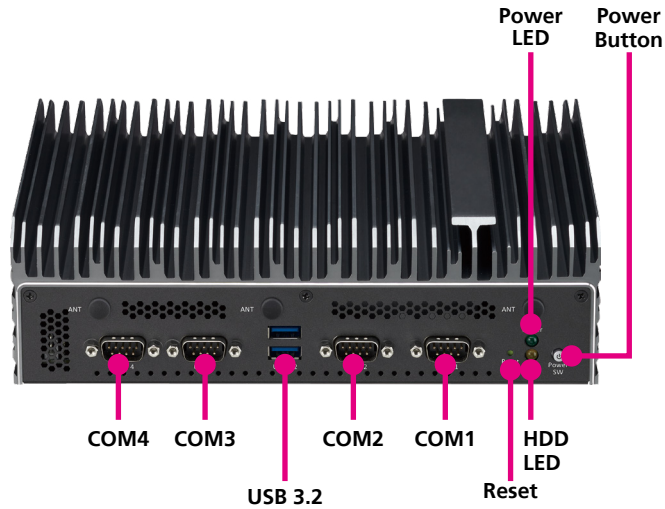

Rear Panel

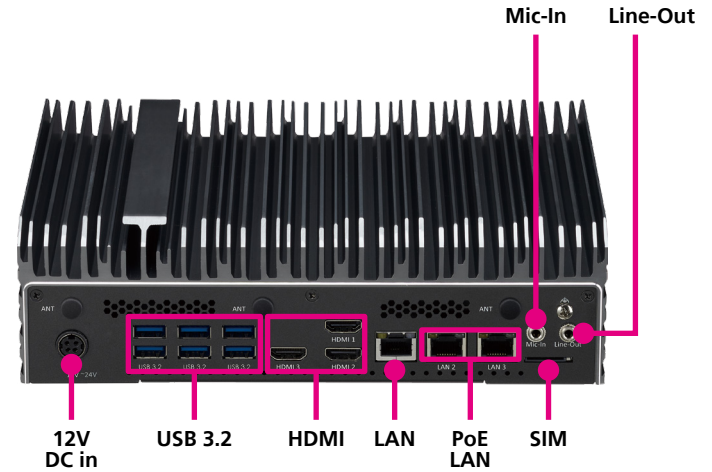

Hardware Specifications

CPU Support

- 12Gen Intel® Core™ i7/i5/i3 LGA socket type processor, up to 35W
 - Core™ i9-12900TE, 16 Core, 1.10GHz, 30M Cache
 - Core™ i7-12700TE, 12 Core, 1.4GHz, 25M Cache
 - Core™ i5-12500TE, 6 Core, 1.9GHz, 18M Cache
 - Core™ i3-12100TE, 4 Core, 2.1GHz, 12M Cache

Chipset

- Intel® PCH Q670E

Graphics

- Intel® UHD graphics 730 series

Main Memory

- 2 x 262-pin SO-DIMM sockets, support DDR5 4800 MHz non-ECC, un-buffered memory up to 64G (single socket max 32GB)

I/O Interface-Front

- 1 x Power button
- 1 x Power LED, 1 x HDD LED
- 1 x Reset switch
- 2 x USB 3.2
- 4x DB9 for COM1~COM4
 - COM1: RS232/422/485
 - COM2~4: RS232
- 3 x Antenna hole

I/O Interface-Rear

- +12~24V DC-in
- 1 x HDMI 2.1, 2 x HDMI 2.0
- 6 x USB 3.2
- 1 x RJ45 LAN 1 with LED for 10/100/1000Mbps
- 2 x RJ45 LAN 2/3 with LED 10/100/1000/2500Mbps
- 1 x Mic-in, 1 x Line-out
- 1 x SIM card
- 3 x Antenna hole

I/O Interface-Internal

- 8CH GPIO support 4 x GPO and 4 x GPI
- Onboard TPM 2.0
- Support iAMT (not for i3)

Storage

- 1 x M.2 2280 (SATA, PCIe x4) Key M socket
- 1 x M.2 2280 (PCIe x4) Key M socket

Expansion

- 1 x M.2 2230 Key E (PCIe x2, USB), support optional Wi-Fi modules
- 1 x M.2 3042/3052 Key B (PCIe x1, USB 3.2), support optional 3G, 4G or, 5G modules
- 1 x SIM slot

Power Supply

- 1 x External AC/DC 12V/120W power adapter

Environment

- Operating temperature: -20°C to 60°C w/ 0.7m/s air flow
- Storage temperature: -20°C to 80°C
- Humidity: 10 to 95% (non-condensing)

Certification

- CE approval
- FCC Class A

Dimensions

- 238mm (W) x 192mm (D) x 67.29mm (H)

Operating System

- Win11/Win10/Linux Kernel

Mechanical Dimensions

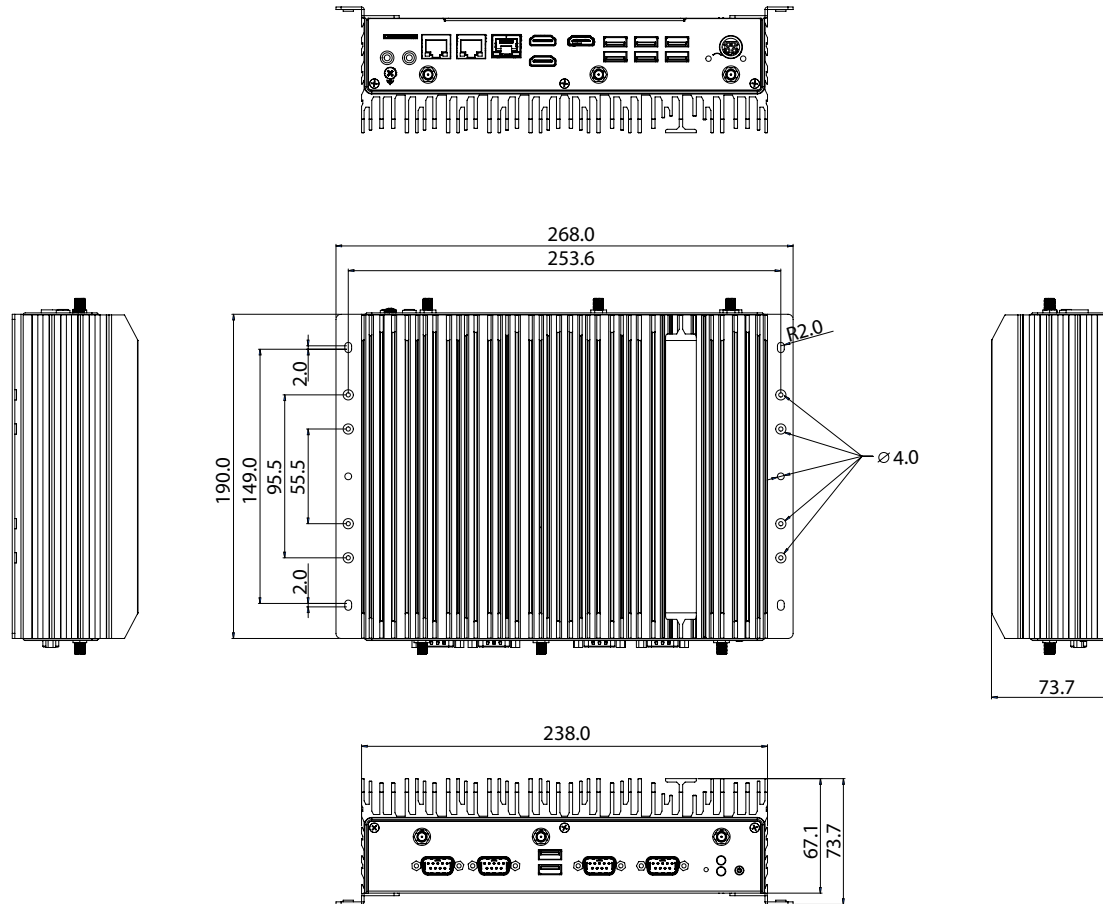

CHAPTER 2: JUMPERS AND CONNECTORS

This chapter describes how to set the jumpers and connectors on the NDiS B561 motherboard.

Before You Begin

- Ensure you have a stable, clean working environment. Dust and dirt can get into components and cause a malfunction. Use containers to keep small components separated.
- Adequate lighting and proper tools can prevent you from accidentally damaging the internal components. Most of the procedures that follow require only a few simple tools, including the following:
 - A Philips screwdriver
 - A flat-tipped screwdriver
 - A set of jewelers screwdrivers
 - A grounding strap
 - An anti-static pad
- Using your fingers can disconnect most of the connections. It is recommended that you do not use needle-nosed pliers to disconnect connections as these can damage the soft metal or plastic parts of the connectors.
- Before working on internal components, make sure that the power is off. Ground yourself before touching any internal components, by touching a metal object. Static electricity can damage many of the electronic components. Humid environments tend to have less static electricity than

dry environments. A grounding strap is warranted whenever danger of static electricity exists.

Precautions

Computer components and electronic circuit boards can be damaged by discharges of static electricity. Working on computers that are still connected to a power supply can be extremely dangerous.

Follow the guidelines below to avoid damage to your computer or yourself:

- Always disconnect the unit from the power outlet whenever you are working inside the case.
- If possible, wear a grounded wrist strap when you are working inside the computer case. Alternatively, discharge any static electricity by touching the bare metal chassis of the unit case, or the bare metal body of any other grounded appliance.
- Hold electronic circuit boards by the edges only. Do not touch the components on the board unless it is necessary to do so. Don't flex or stress the circuit board.
- Leave all components inside the static-proof packaging that they shipped with until they are ready for installation.
- Use correct screws and do not over tighten screws.

Locations of the Jumpers and Connectors for NDiB B561

The following figures show the top and bottom views of the NDiB B561, which is the main board used in the NDiB B561. They illustrate the locations of the jumpers and connectors. For more detailed information on pin settings and definitions marked in pink on this figure, please refer to this chapter.

Top View

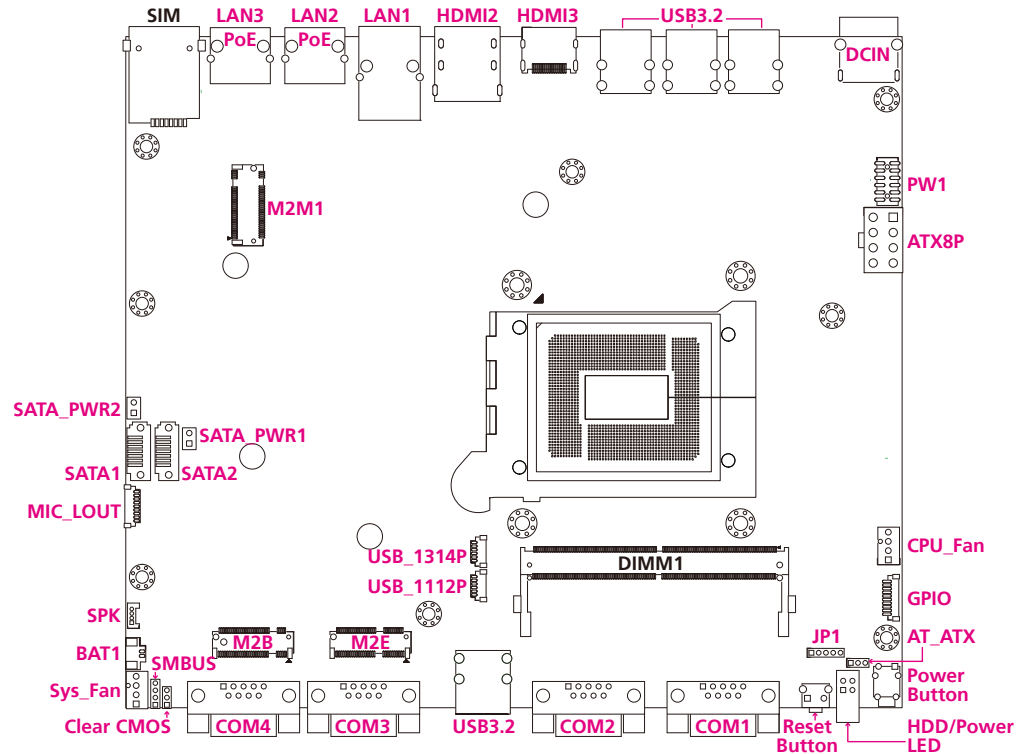

Bottom View

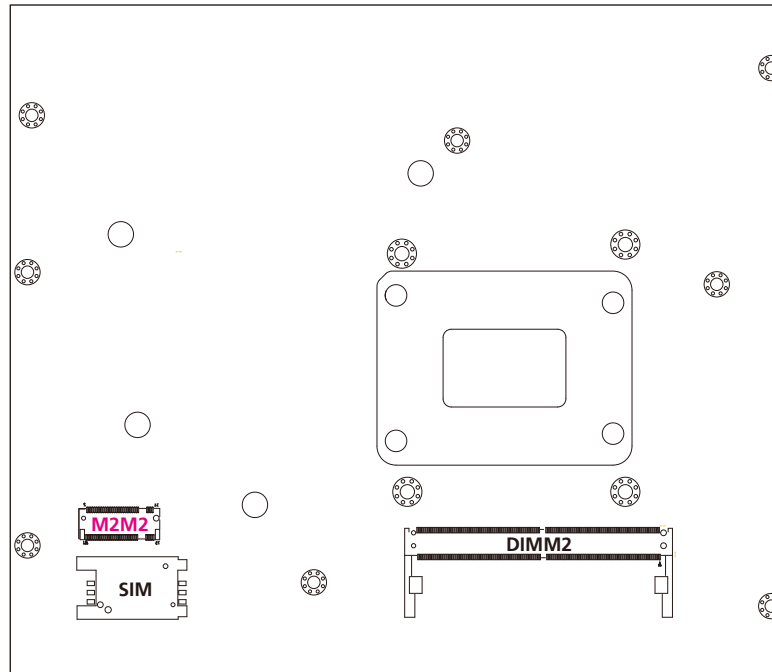

Jumper Settings

A jumper is the simplest kind of electric switch. It consists of two metal pins and a cap. When setting the jumpers, ensure that the jumper caps are placed on the correct pins. When the jumper cap is placed on both pins, the jumper is short. If you remove the jumper cap, or place the jumper cap on just one pin, the jumper is open.

Refer to the illustrations below for examples of what the 2-pin and 3-pin jumpers look like when they are short (on) and open (off).

Two-Pin Jumpers: Open (Left) and Short (Right)

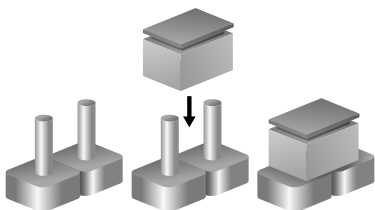

Three-Pin Jumpers: Pins 1 and 2 are Short

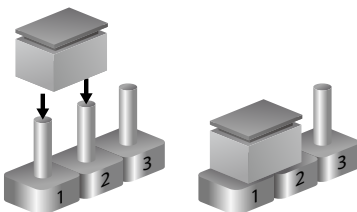

Jumper Settings

AT/ATX Mode Selection

Connector type: Header 1X3P, 2.0mm, S/T

Connector location: AT_ATX

1  3

Pin	Mode
1-2 On	AT Mode
2-3 On	ATX Mode (Default)

CMOS Clear Selection

Connector type: Header 1X5P, 2.0mm, S/T

Connector location: JP1

1  5

Pin	Mode
1-2 On	COM2 RI = Ring (Default)
2-3 On	COM2 RI = +5V
4-5 On	COM2 RI = +12V

Connector Pin Definitions

External I/O Interfaces

COM Ports

Connector type: D-Sub CON 9P 90D Male

Connector location: COM1 ~ COM4

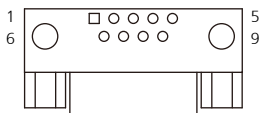

Pin	Definition	Pin	Definition
1	DCD#	2	RXD
3	TXD	4	DTR#
5	GND	6	DSR#
7	RTS#	8	CTS#
9	RI#		
MH1	CGND	MH2	CGND

DC Input (+12~24V)

Connector location: DCIN

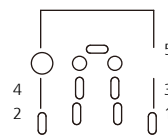

Pin	Definition
1	+12VSUS
2	+12VSUS
3	GND
4	GND
5	CGND

HDMI Connector

Connector type: HDMI CON 19P G/F R/A SMT

Connector location: HDMI

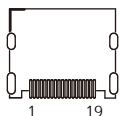

Pin	Definition	Pin	Definition
1	HDMI1_TX2P	2	GND
3	HDMI1_TX2N	4	HDMI1_TX1P
5	GND	6	HDMI1_TX1N
7	HDMI1_TX0P	8	GND
9	HDMI1_TX0N	10	HDMI1_CLK_P
11	GND	12	HDMI1_CLK_N
13	NC	14	NC
15	HDMI1_SCL	16	HDMI1_SDA
17	GND	18	HDMI1_P5V
19	HDMI1_HPD	MH1	CGND
MH2	CGND	MH3	CGND
MH4	CGND		

HDMI Connectors

Connector type: HDMI CON Dual 38P R/A DIP

Connector location: HDMI2, HDMI3

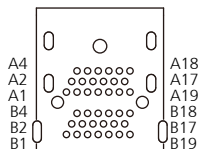

Pin	Definition	Pin	Definition
A1	HDMI1_TX2P	A2	GND
A3	HDMI1_TX2N	A4	HDMI1_TX1P
A5	GND	A6	HDMI1_TX1N
A7	HDMI1_TX0P	A8	GND
A9	HDMI1_TX0N	A10	HDMI1_CLK_P
A11	GND	A12	HDMI1_CLK_N
A13	NC	A14	NC
A15	HDMI1_SCL	A16	HDMI1_SDA
A17	GND	A18	HDMI1_P5V
A19	HDMI1_HPD		
B1	HDMI2_TX2P	B2	GND
B3	HDMI2_TX2N	B4	HDMI2_TX1P

Pin	Definition	Pin	Definition
B5	GND	B6	HDMI2_TX1N
B7	HDMI2_TX0P	B8	GND
B9	HDMI2_TX0N	B10	HDMI2_CLK_P
B11	GND	B12	HDMI2_CLK_N
B13	NC	B14	NC
B15	HDMI2_SCL	B16	HDMI2_SDA
B17	GND	B18	HDMI2_P5V
B19	HDMI2_HPD		
GND1	CGND	GND2	CGND
GND3	CGND	GND4	CGND
GND5	CGND	GND6	CGND

LAN Ports

Connector type: LAN Jack Single W/LED R/A DIP

Connector location: LAN1

Connector location: LAN2, LAN3

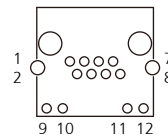
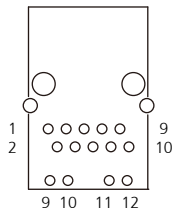

Pin	Definition	Pin	Definition
1	LAN1_MDIOP	2	LAN1_MDI0N
3	LAN1_MDI1P	4	LAN1_MDI1N
5	TCT	6	TCTG
7	LAN1_MDI2P	8	LAN1_MDI2N
9	LAN1_MDI3P	10	LAN1_MDI3N
11	LAN1LED1G#	12	LAN1LED100#
13	LAN1LEDACTN	14	LAN1ACTPW
MH1	CGND	MH2	CGND

Pin	Definition	Pin	Definition
1	LAN1_MDIOP	2	LAN1_MDI0N
3	LAN1_MDI1P	4	LAN1_MDI2P
5	LAN1_MDI2N	6	LAN1_MDI1N
7	LAN1_MDI3P	8	LAN1_MDI3N
9	LAN1_LED_LINK100#	10	LAN1_LED_LINK2500#
11	LAN1_LED_ACT#	12	LAN1_LED_ACT_POWER
MH1	CGND	MH2	CGND

Power Button

Connector type: WtoB CON 2P, 1.0mm, S/T
Connector location: Power Button



Pin	Definition
1	GND
2	PWRBTN#

Reset Button

Connector type: Header 1X2P, 2.0mm, S/T
Connector location: Reset Button



Pin	Definition
1	GND
2	RESET#

USB Ports

Connector type: USB 3.2

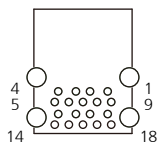

Pin	Definition	Pin	Definition
1	+5V	2	USB2_3N
3	USB2_3P	4	GND
5	USB3_RX3N	6	USB3_RX3P
7	GND	8	USB3_TX3N
9	USB3_TX3P	10	+5V
11	USB2_4N	12	USB2_4P
13	GND	14	USB3_RX4N
15	USB3_RX4P	16	GND
17	USB3_TX4N	18	USB3_TX4P
MH1	CGND	MH2	CGND
MH3	CGND	MH4	CGND

Internal Connectors

ATX +12V Power Connector

Connector type: ATX Power CON 2x4 Male 180D

Connector location: ATX8P

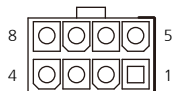

Pin	Definition	Pin	Definition
1	GND	5	+12V
2	GND	6	+12V
3	GND	7	+12V
4	GND	8	+12V

Battery Connector

Connector type: WtoB CON 2P, 1.25mm, R/A

Connector location: BAT1



Pin	Definition
1	GND
2	BAT

Fan Connectors

Connector type: WtoB CON 4P, 2.54mm, S/T

Connector location: CPU_Fan, Sys_Fan

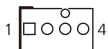

Pin	Definition
1	GND
2	+12V
3	FAN SPEED DETECT
4	FAN SPEED CONTROL

GPIO Connector

Connector type: WtoB CON 10P, 1.0mm, S/T

Connector location: GPIO



Pin	Definition	Pin	Definition
1	+5V	2	GND
3	GPO0	4	GPO1
5	GPO2	6	GPO3
7	GPIO	8	GPI1
9	GPI2	10	GPI3

MIC-In LINE-Out Connector

Connector type: WtoB CON 9P, 1.0mm, S/T

Connector location: MIC_LOUT



Pin	Definition	Pin	Definition
1	LINE_OUT-R	2	LINE_JD
3	AUDGND	4	LINE_OUT-L
5	AUDGND	6	MIC_OUT-R
7	MIC_JD	8	MIC_OUT-L
9	AUDGND		

M.2 Key B 3042/3052 Slot

Connector location: M2B

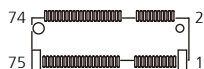

Pin	Definition	Pin	Definition
1	CONFIG3	2	3.3V
3	GND	4	3.3V
5	GND	6	POWER_OFF#
7	USB2_5P	8	WIFI_DIS#
9	USB2_5N	10	LED#
11	NC		
Key			
		20	Telit FN980 PCIe/USB Select Pin
21	CONFIG0	22	NC
23	NC	24	NC
25	NC	26	WWAN_GPS_ON
27	GND	28	NC
29	USB3_RXN	30	UIM_RESET
31	USB3_RXP	32	UIM_CLK
33	GND	34	UIM_DATA
35	USB3_TXN	36	UIM_PWR
37	USB3_TXP	38	NC
39	GND	40	NC

Pin	Definition	Pin	Definition
41	PCIEX_RXN	42	NC
43	PCIEX_RXP	44	NC
45	GND	46	NC
47	PCIEX_TXN	48	NC
49	PCIEX_TXP	50	RESET(3.3V)
51	GND	52	CLKREQ#
53	CLK_DN	54	WAKE#
55	CLK_DP	56	NC
57	GND	58	NC
59	NC	60	NC
61	NC	62	NC
63	NC	64	NC
65	NC	66	NC
67	RESET(1.8V)	68	SUS_CLK
69	CONFIG1	70	3.3V
71	GND	72	3.3V
73	GND	74	3.3V
75	CONFIG2		

M.2 Key E 2230 Slot

Connector location: M2E

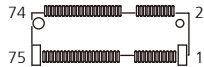

Pin	Definition	Pin	Definition
1	GND	2	3.3V_1
3	USB_D+	4	3.3V_2
5	USB_D-	6	LED1#
7	GND2	8	PCM_CLK
9	SDIO_CLK	10	PCM_SYNC
11	SDIO_CMD	12	PCM_IN
13	SDIO_DATA0	14	PCM_OUT
15	SDIO_DATA1	16	LED2#
17	SDIO_DATA2	18	GND3
19	SDIO_DATA3	20	UART_WAKE#
21	SDIO_WAKE#	22	UART_RXD
23	SDIO_RESET#		
Key			
33	GND4	34	UART_CTS
35	PETP0	36	UART_RTS
37	PETN0	38	RESERVED_1
39	GND5	40	RESERVED_2
41	PERP0	42	RESERVED_3

Pin	Definition	Pin	Definition
43	PERN0	44	COEX3
45	GND6	46	COEX2
47	REFCLKP0	48	COEX1
49	REFCLKN0	50	SUSCLK
51	GND7	52	PERSTO#
53	CLKREQ0#	54	W_DISABLE2#
55	PEWAKE0#	56	W_DISABLE1#
57	GND8	58	I2C_DATA
59	PETP1	60	I2C_CLK
61	PETN1	62	ALERT#
63	GND9	64	RESERVED
65	PERP1	66	UIM_SWP
67	PERN1	68	UIM_POWER_SNK
69	GND10	70	UIM_POWER_SRC
71	PEFCLKP1	72	3.3V_3
73	PEFCLKN1	74	3.3V_4
75	GND11		

M.2 Key M 2280 Slot

Connector location: M2M1 (supports PCIe only)

Connector location: M2M2 (supports PCIe + SATA)

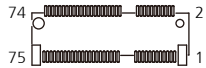

Pin	Definition	Pin	Definition
1	GND	2	VCC3
3	GND	4	VCC3
5	PCIE3_RXN	6	NC
7	PCIE3_RXP	8	NC
9	GND	10	M2M_LED#
11	PCIE3_TXN	12	VCC3
13	PCIE3_TXP	14	VCC3
15	GND	16	VCC3
17	PCIE2_RXN	18	VCC3
19	PCIE2_RXP	20	NC
21	GND	22	NC
23	PCIE2_TXN	24	NC
25	PCIE2_TXP	26	NC
27	GND	28	NC
29	PCIE1_RXN	30	NC
31	PCIE1_RXP	32	NC
33	GND	34	NC
35	PCIE1_TXN	36	NC

Pin	Definition	Pin	Definition
37	PCIE1_TXP	38	DEVSHP
39	GND	40	NC
41	SATA_RXP(PCIE0_RXP)	42	NC
43	SATA_RXN(PCIE0_RXN)	44	NC
45	GND	46	NC
47	SATA_TXN(PCIE0_TXN)	48	NC
49	SATA_TXP(PCIE0_TXP)	50	RESET#
51	GND	52	CLKREQ#
53	CLK_PCIEN	54	WAKE#
55	CLK_PCIEP	56	NC
57	GND	58	NC
Key	M2M_PEDET	70	VCC3
67	NC	68	NC
69	M2M_PEDET	70	VCC3
71	GND	72	VCC3
73	GND	74	VCC3
75	GND		

SATA Connectors

Connector type: SATA CON 7P, 1.27mm, S/T

Connector location: SATA1, SATA2



Pin	Definition
1	GND
2	SATA_TXP
3	SATA_TXN
4	GND
5	SATA_RXN
6	SATA_RXP
7	GND

SATA Power Connectors

Connector type: WtoB CON 2P, 2.5mm, S/T

Connector location: SATA_PWR1, SATA_PWR2

Pin	Definition
1	+5V
2	GND

SMBus/I2C Connector

Connector type: WtoB CON 4P, 2.0mm, S/T

Connector location: SMBUS



Pin	Definition
1	VCC3
2	SMBCLK
3	SMBDAT
4	GND

Speaker Connector

Connector type: WtoB CON 4P, 1.25mm, S/T

Connector location: SPK



Pin	Definition
1	R_OUT-
2	R_OUT+
3	L_OUT-
4	L_OUT+

USB 2.0 Connectors

Connector location: USB2_1112P, USB2_1314P



Pin	Definition
1	GND
2	USB2N
3	USB2P
4	USB1N
5	USB1P
6	+5V

LED Indicators

LAN Port LEDs

Connector type: RJ45 port with LEDs
 Connector location: LAN1, LAN2, LAN3

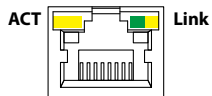

LAN Speed	Act. (Left)	Link (Right)
1G/2.5G	Blinking Yellow	Steady Green
10/100Mbps	Blinking Yellow	Steady Yellow
No Active	Off	Off

Status Indicators

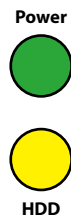

Indicator	Status	LED
Power	Power on	Steady Green
	Power off	No light
HDD	Connected	Steady Yellow
	Disconnected / Read / Write non-working	No light
	Read / Write working	Blinking Yellow

CHAPTER 3: SYSTEM SETUP

Removing the Chassis Cover



Prior to removing the chassis cover, make sure the unit's power is off and disconnected from the power sources to prevent electric shock or system damage.

The expansion modules mentioned in this chapter are foolproof and can only be installed in one direction. If you encounter difficulty, try reversing the module's orientation and avoid using force to prevent damage.

1. To install the expansion or memory modules, refer to the following images to locate the screws. The screws on the front, rear, and bottom are used to secure the cover to the chassis. Remove the screws and put them in a safe place for later use.

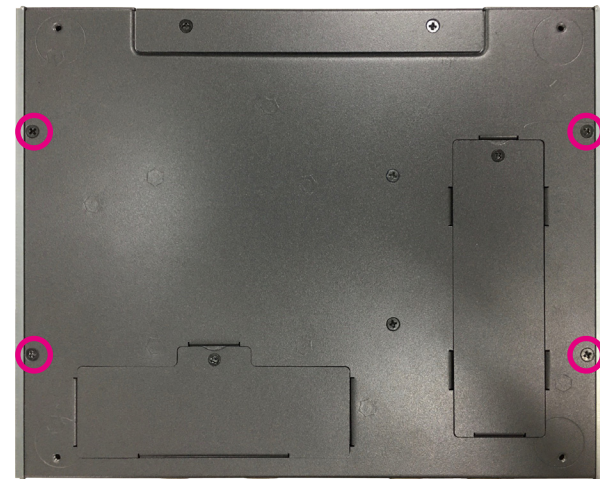

2. Remove the top cover.

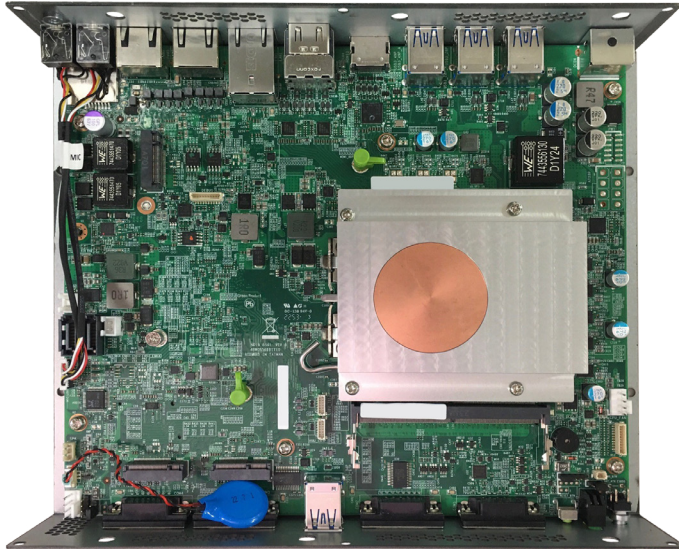

Installing a CPU

1. Remove the four screws and CPU heatsink.

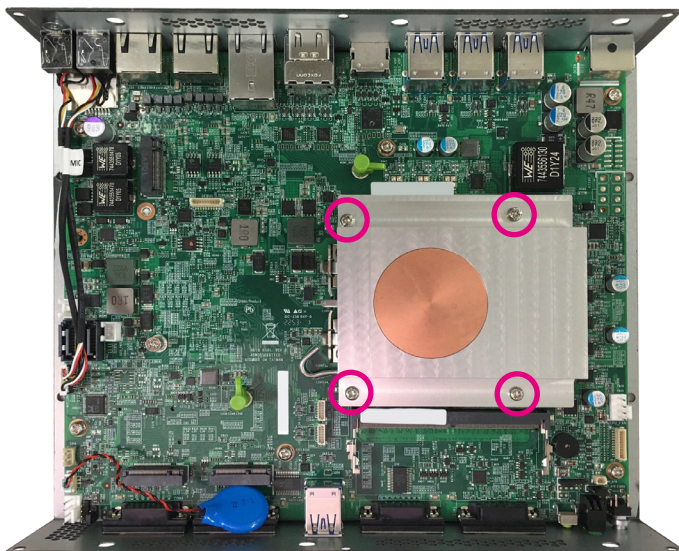

2. Locate the CPU socket on the board. Unlock the socket by pushing the load lever down, moving it sideways until it is released from the retention tab.

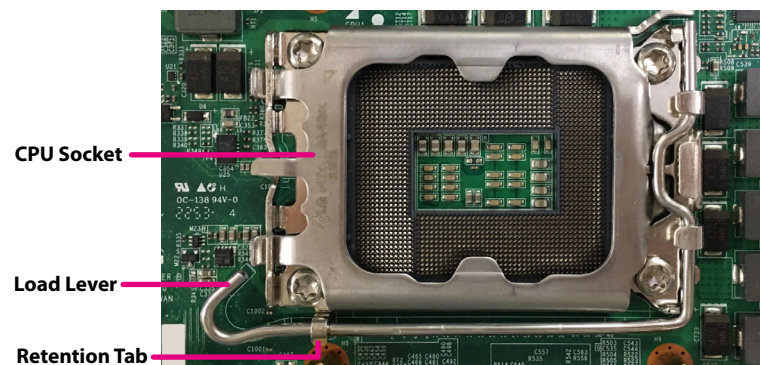

3. Lift the load lever up to open the CPU retention bracket.

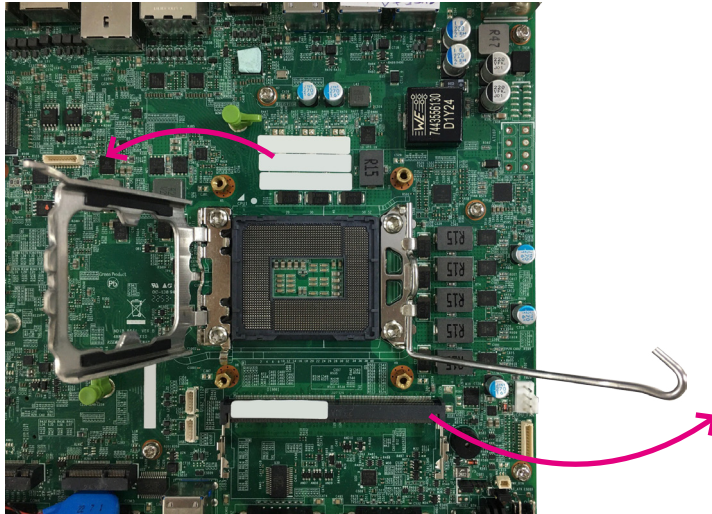

4. Insert the CPU into the socket. The triangular edge (▽) on the CPU must align with the corner of the CPU socket shown in the photo. The CPU's notch will at the same time fit into the socket's alignment key (○).

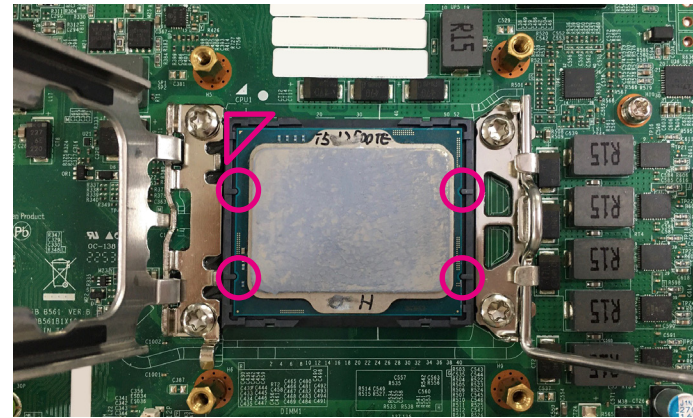

1. Handle the CPU by its edges and avoid touching the pins.
2. The CPU will fit only in one orientation and can easily be inserted without exerting any force.

5. With the CPU installed, close the retention bracket and then hook the load lever under the retention tab.



7. Align the CPU heatsink, and then secure the CPU heatsink with the four screws.

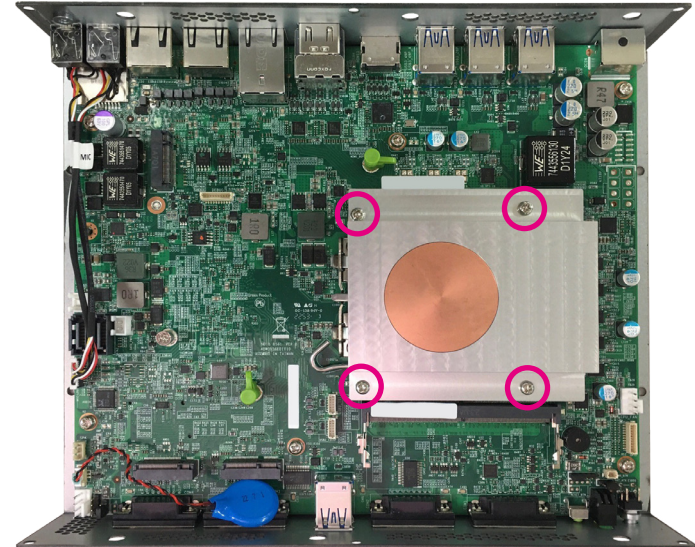

Do not force the CPU into the socket. Forcing the CPU into the socket may bend the pins and damage the CPU.

6. Applying thermal paste before assembling the heatsink to ensure proper heat transfer between the CPU and the heatsink.

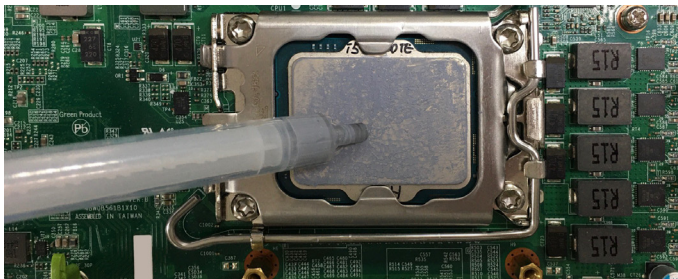

Installing a SO-DIMM (DIMM1)

1. Locate the SO-DIMM socket on the board.
2. Insert the module into the socket the an approximately 30 degrees angle. The ejector tabs at the ends of the socket will automatically snap into the locked position to hold the module in place.

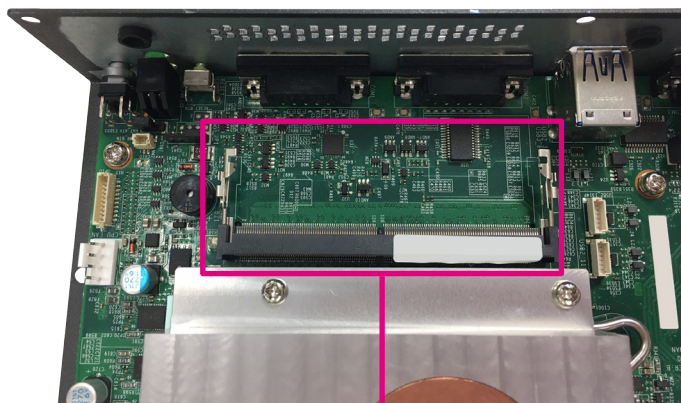

SO-DIMM 1 socket

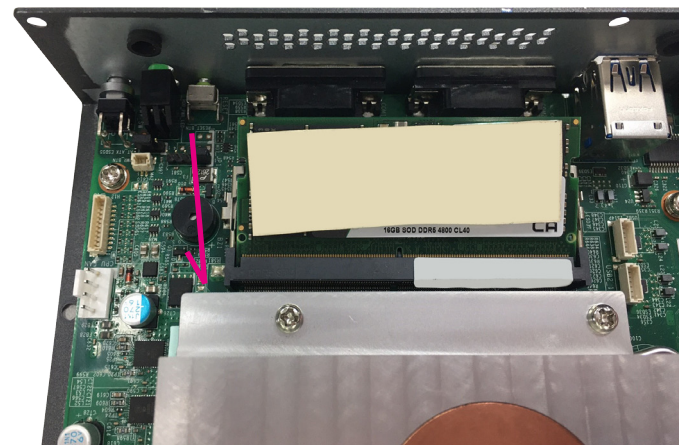

Installing a SO-DIMM (DIMM2)

1. Remove the screw from the SO-DIMM cover at the bottom side.

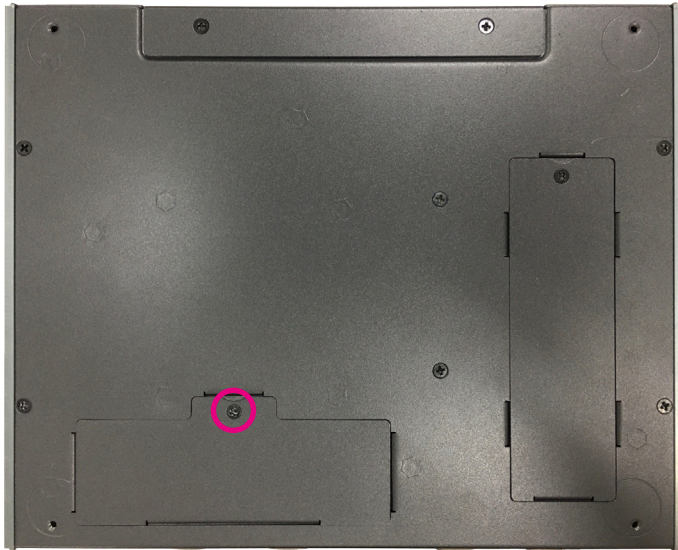

2. Insert the module into the socket at an approximately 30 degrees angle. The ejector tabs at the ends of the socket will automatically snap into the locked position, holding the module in place.

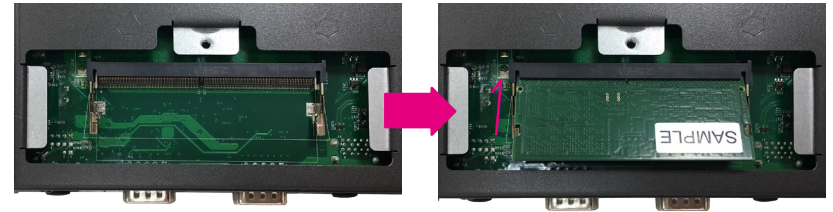

3. Refer to step 1 to secure the SO-DIMM cover back in place using the screw.

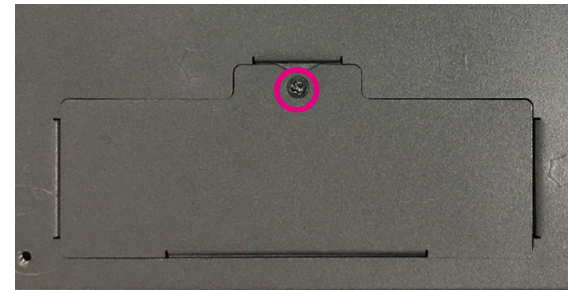

Installing a M.2 Storage Module (M2M1)

1. Locate the M.2 2280 Key M slot (M2M1) on the motherboard and pull out the plastic standoff.

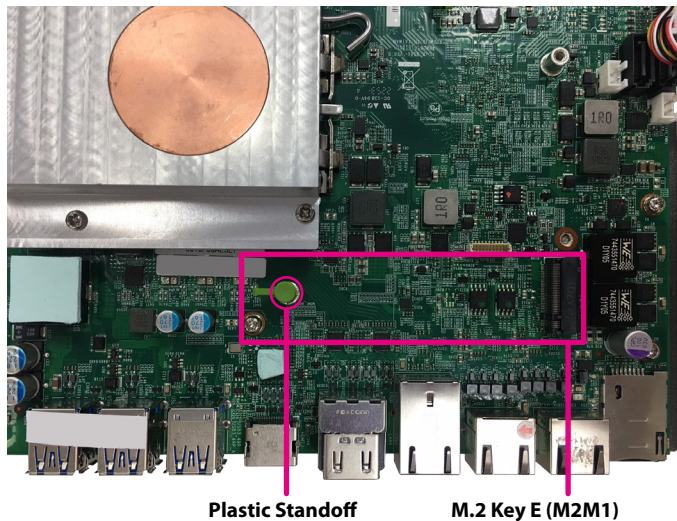

2. Insert the M.2 module into the M.2 slot at a 45-degree angle until the gold-plated connector on the edge of the module completely disappears into the slot.

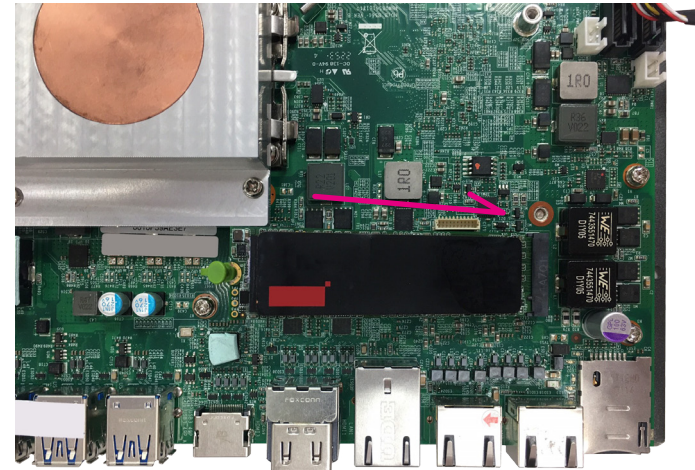

3. Push the module down and use the notch on the middle of the plastic standoff to secure the M.2 module.



The plastic standoff is subject to change depending on the packaging requirements. The installation process shown here uses a plastic standoff but may be replaced with a screw.



When purchasing an M.2 storage, it is recommended to use a complementary dedicated thermal pad. Stick it to the original set of M.2 module for a better heat dissipation.

Installing a M.2 Storage Module (M2M2)

1. Remove the screw from the M.2 cover at the bottom side.

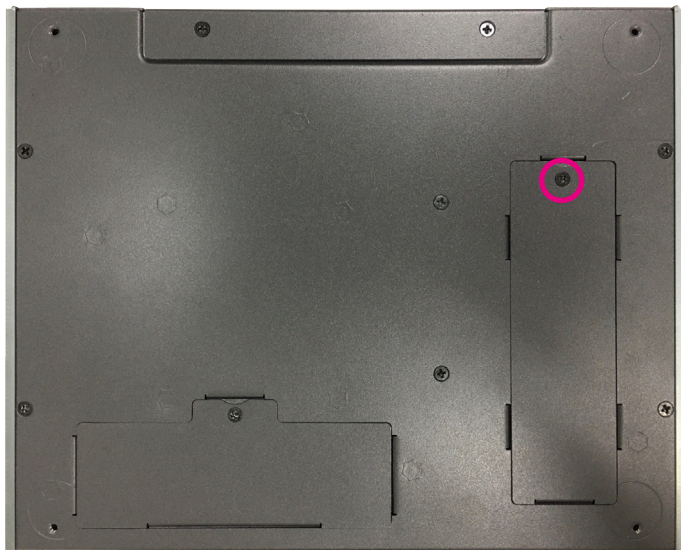

2. Loosen the screw on the M.2 standoff, then insert the M.2 module into the M.2 slot at a 45-degree angle until the gold-plated connector on the edge of the module completely disappears into the slot.

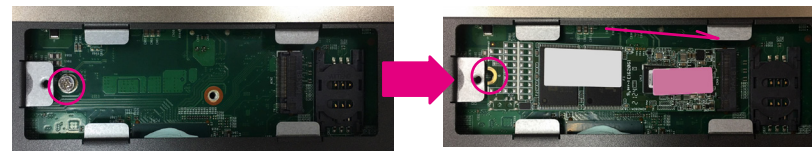

3. Refer to step 1 to secure the M.2 cover back in place using the screw.

Installing a M.2 WiFi Module (Key E 2230)

1. Locate the M.2 Key E slot on the motherboard.

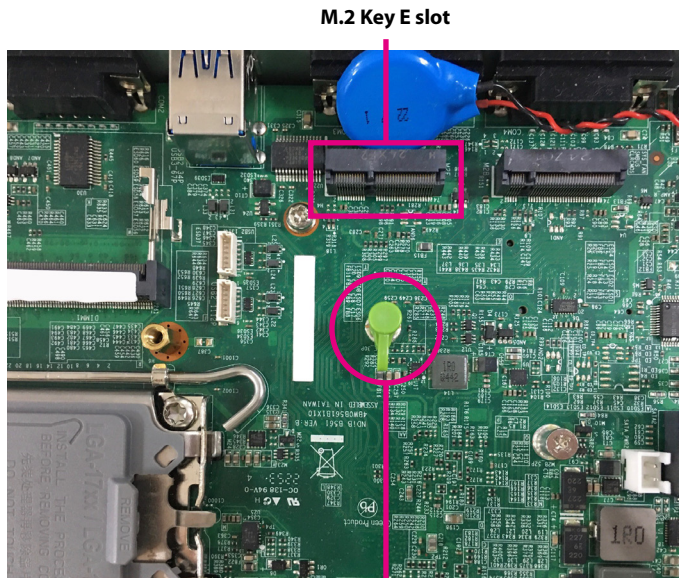

Plastic Standoff

2. Pull out the plastic standoff. Insert the WiFi module into the M.2 Key E slot at a 45-degree angle until the gold-plated connector on the edge of the module completely disappears into the slot. Gently push down on the M.2 module and insert the notch of the module into the corresponding notch in the middle of the plastic standoff.

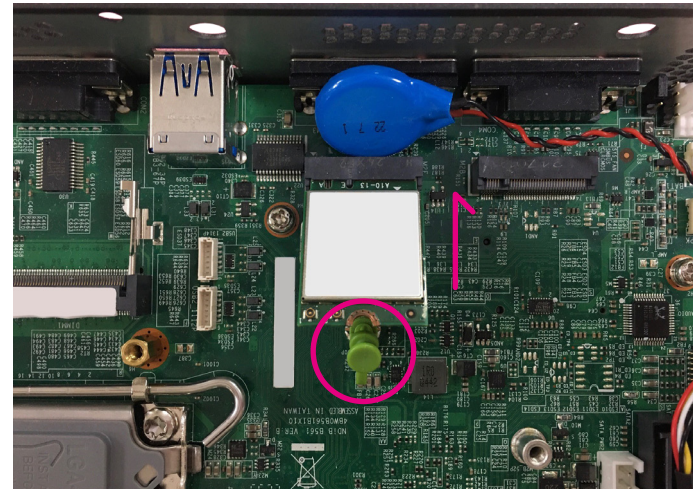

3. Afterward, firmly press the plastic standoff back to its original position.

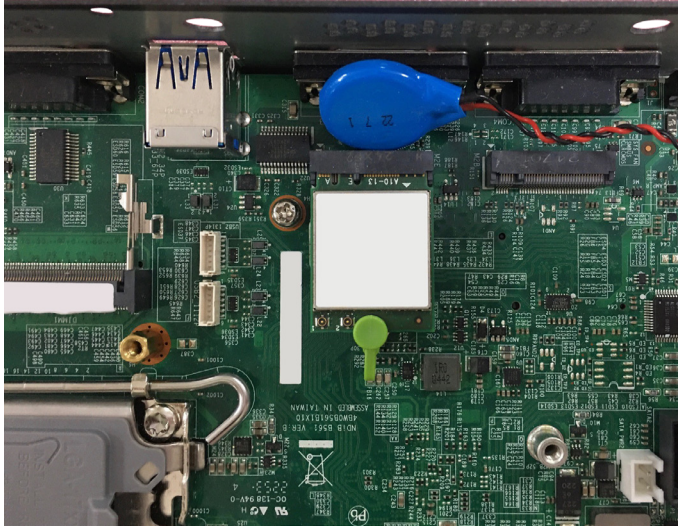

The plastic standoff is subject to change depending on the packaging requirements. The installation process shown in this section uses a plastic standoff but may be replaced with a screw.

Installing a M.2 Mobile Network Module (Key B 3042/3052)

1. Locate the M.2 Key B slot on the motherboard and insert the mobile network module into the M.2 Key E slot at a 45-degree angle until the gold-plated connector on the edge of the module completely disappears into the slot.
2. Push the mobile network module down and secure it with the screw.

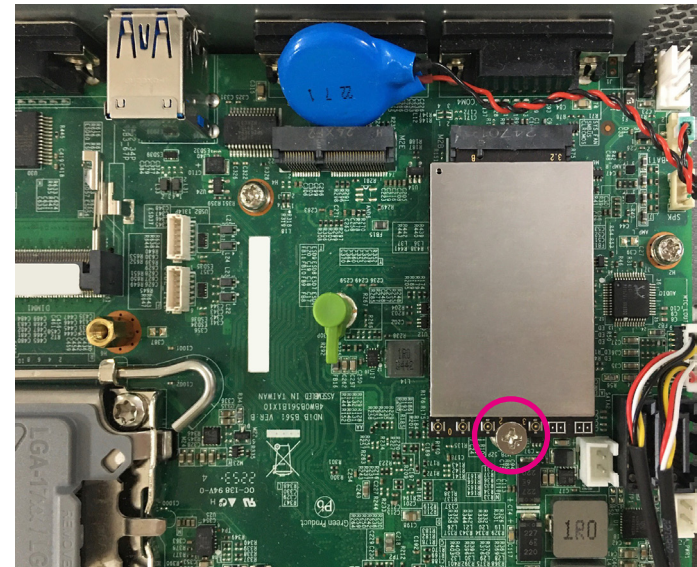
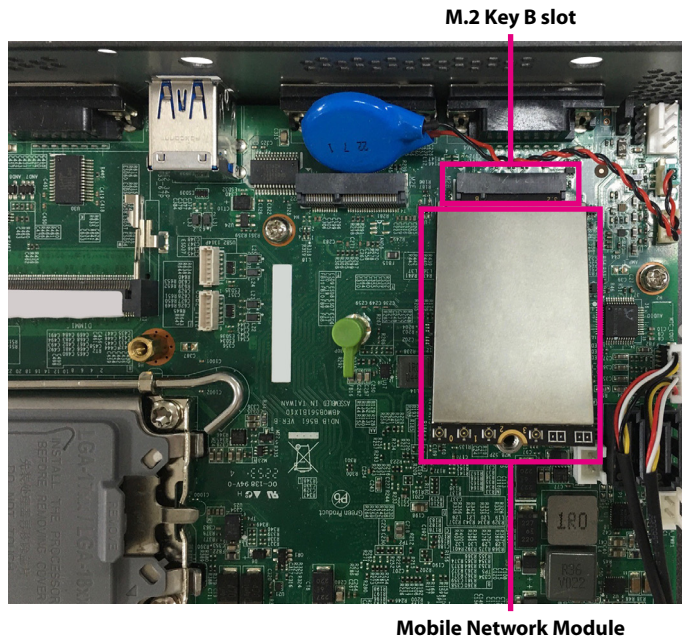

CHAPTER 4: BIOS SETUP

This chapter describes how to use the BIOS setup program for the NDiS B561. The BIOS screens provided in this chapter are for reference only and may change if the BIOS is updated in the future.

To check for the latest updates and revisions, visit the NEXCOM Web site at www.nexcom.com.tw.

About BIOS Setup

The BIOS (Basic Input and Output System) Setup program is a menu driven utility that enables you to make changes to the system configuration and tailor your system to suit your individual work needs. It is a ROM-based configuration utility that displays the system's configuration status and provides you with a tool to set system parameters.

These parameters are stored in non-volatile battery-backed-up CMOS RAM that saves this information even when the power is turned off. When the system is turned back on, the system is configured with the values found in CMOS.

With easy-to-use pull down menus, you can configure such items as:

- Hard drives, diskette drives, and peripherals
- Video display type and display options
- Password protection from unauthorized use
- Power management features

The settings made in the setup program affect how the computer performs. It is important, therefore, first to try to understand all the setup options, and second, to make settings appropriate for the way you use the computer.

When to Configure the BIOS

- This program should be executed under the following conditions:
 - When changing the system configuration
 - When a configuration error is detected by the system and you are prompted to make changes to the setup program
 - When resetting the system clock
 - When redefining the communication ports to prevent any conflicts
 - When making changes to the Power Management configuration
 - When changing the password or making other changes to the security setup

Normally, CMOS setup is needed when the system hardware is not consistent with the information contained in the CMOS RAM, whenever the CMOS RAM has lost power, or the system features need to be changed.

Default Configuration

Most of the configuration settings are either predefined according to the Load Optimal Defaults settings which are stored in the BIOS or are automatically detected and configured without requiring any actions. There are a few settings that you may need to change depending on your system configuration.

Entering Setup











When the system is powered on, the BIOS will enter the Power-On Self Test (POST) routines. These routines perform various diagnostic checks; if an error is encountered, the error will be reported in one of two different ways:

- If the error occurs before the display device is initialized, a series of beeps will be transmitted.
- If the error occurs after the display device is initialized, the screen will display the error message.

Powering on the computer and immediately pressing allows you to enter Setup.

Press the  key to enter Setup:

Legends

Key	Function
	Moves the highlight left or right to select a menu.
	Moves the highlight up or down between sub-menus or fields.
	Exits the BIOS Setup Utility.
	Scrolls forward through the values or options of the highlighted field.
	Scrolls backward through the values or options of the highlighted field.
	Selects a field.
	Displays General Help.
	Load previous values.
	Load optimized default values.
	Saves and exits the Setup program.
	Press <Enter> to enter the highlighted sub-menu

Scroll Bar

When a scroll bar appears to the right of the setup screen, it indicates that there are more available fields not shown on the screen. Use the up and down arrow keys to scroll through all the available fields.

Submenu

When “▶” appears on the left of a particular field, it indicates that a submenu which contains additional options are available for that field. To display the submenu, move the highlight to that field and press  .

BIOS Setup Utility

Once you enter the AMI BIOS Setup Utility, the Main Menu will appear on the screen. The main menu allows you to select from several setup functions and one exit. Use arrow keys to select among the items and press  to accept or enter the submenu.

Main

The Main menu is the first screen that you will see when you enter the BIOS Setup Utility.

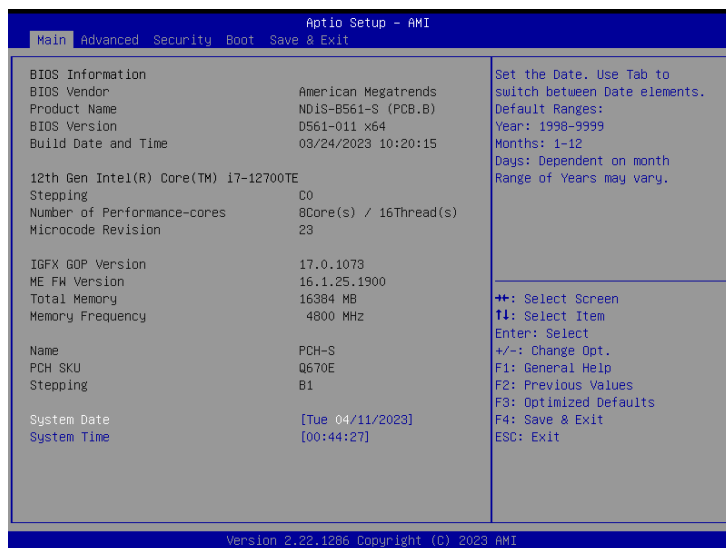

System Date

The date format is <day>, <month>, <date>, <year>. Day displays a day, from Monday to Sunday. Month displays the month, from January to December. Date displays the date, from 1 to 31. Year displays the year, from 1999 to 2099.

System Time

The time format is <hour>, <minute>, <second>. The time is based on the 24-hour military-time clock. For example, 1 p.m. is 13:00:00. Hour displays hours from 00 to 23. Minute displays minutes from 00 to 59. Second displays seconds from 00 to 59.

Advanced

The Advanced menu allows you to configure your system for basic operation. Some entries are defaults required by the system board, while others, if enabled, will improve the performance of your system or let you set some features according to your preference.



Setting incorrect field values may cause the system to malfunction.

State After G3

Specify what state to go to when power is re-applied after a power failure (G3 state).

Wake on LAN/COM

Enable or disable the integrated LAN/COM to wake the system.

USB Power State in S5

Configure the USB power state in S5.

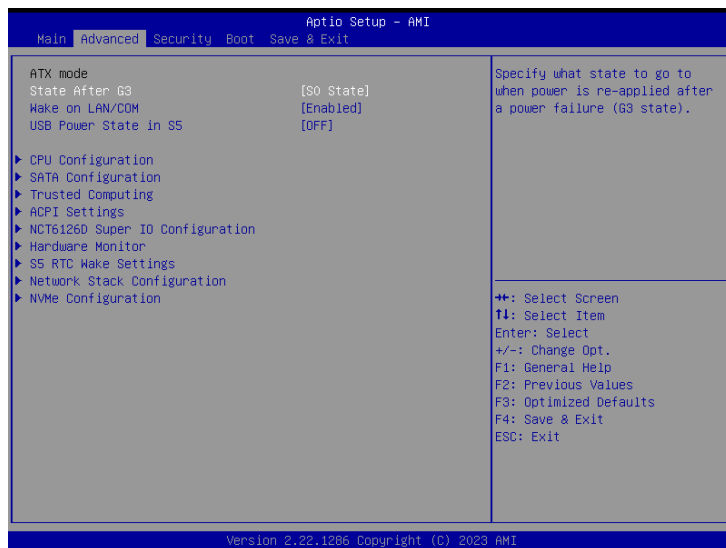

CPU Configuration

This section is used to view CPU status and configure CPU parameters.

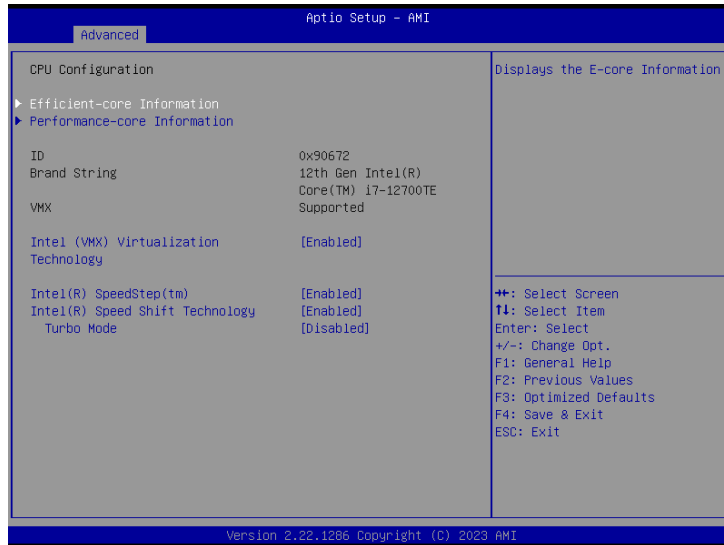

Intel® Virtualization Technology

When this field is set to Enabled, the VMM can utilize the additional hardware capabilities provided by Vanderpool Technology.

Intel® SpeedStep(tm)

Enable or disable Intel SpeedStep.

Intel® Speed Shift Technology

Enable or disable Intel Speed Shift Technology support. Enabling it will expose the CPPC v2 interface to allow hardware controlled P-states.

Turbo Mode

Enable or disable turbo mode.

Efficient-core Information

This section is used to display the CPU E-core information.



Performance-core Information

This section is used to display the CPU P-core information.

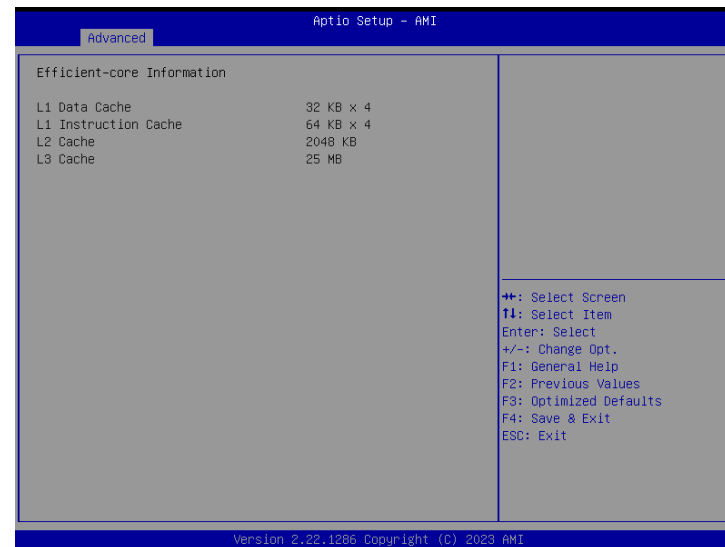

Trusted Computing

This section is used to configure Trusted Platform Module (TPM) settings.



Pending operation

Schedules an operation for the security device.

Platform Hierarchy

Enables or disables platform hierarchy.

Storage Hierarchy

Enables or disables storage hierarchy.

Endorsement Hierarchy

Enables or disables endorsement hierarchy

Security Device Support

Enable or disable BIOS support for security device. O.S. will not show security device. TCG EFI protocol and INT1A interface will not be available.

SHA256 PCR Bank

Enable or disable SHA256 PCR Bank.

ACPI Settings

This section is used to configure ACPI settings.



Enable Hibernation

Enable or disable system ability to hibernate (OS/S4 Sleep State). This option may not be effective with some operating systems.

ACPI Sleep State

Select the highest ACPI sleep state the system will enter when the suspend button is pressed. The options are Suspend Disabled and S3 (Suspend to RAM).

NCT6126D Super IO Configuration

This section is used to configure the serial ports.

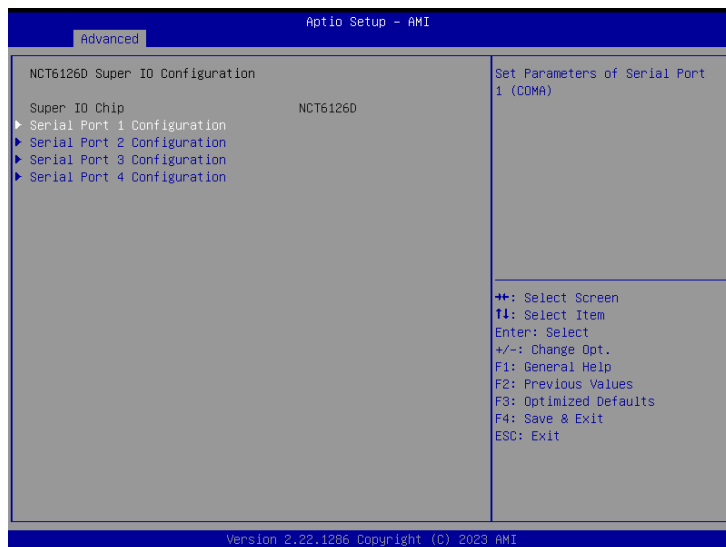

Super IO Chip

Displays the Super I/O chip used on the board.

Serial Port 1/2/3/4 Configuration

This section is used to configure serial port 1/2/3/4.



Serial Port

Enable or disable the serial port.

Onboard Serial Port 1 Mode

Select this to change the serial port mode to RS232, RS422 or RS485.

Hardware Monitor

This section is used to monitor hardware status such as temperature, fan speed and voltages.

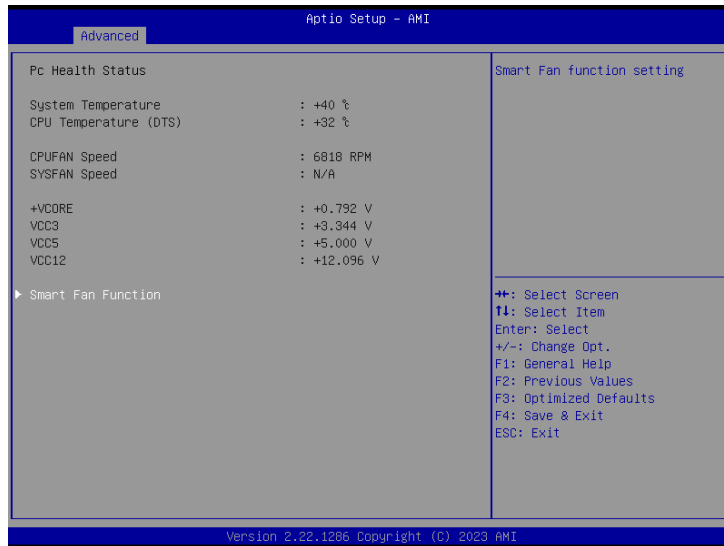

Smart Fan Function

Enter the Smart Fan Function sub-menu.

Smart Fan Function



SYSFAN Setting > SYSFAN Mode

Select fan control mode.

SYSFAN Setting > Manual PWM

Configure the fan speed manually when the fan mode is set to Manual mode.

CPUFAN Setting > CPUFAN Mode

Select fan control mode.

CPUFAN Setting > Manual PWM

Configure the fan speed manually when the fan mode is set to Manual mode.

S5 RTC Wake Settings

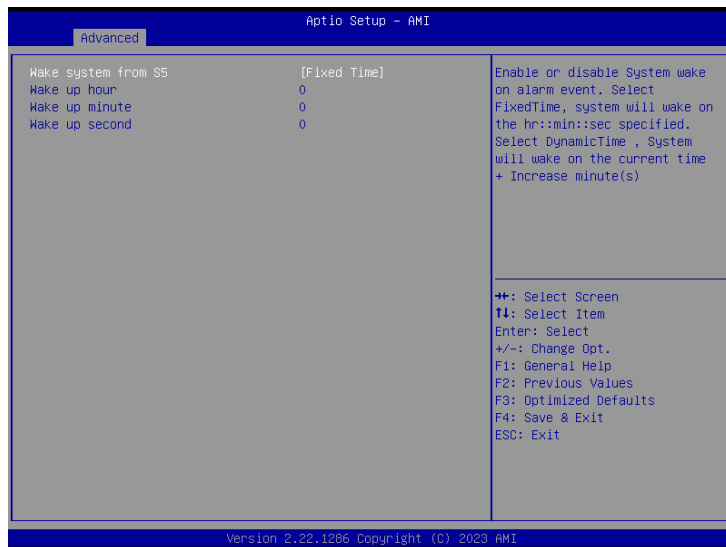

Wake system from S5

Enable or disable system wake on alarm event. Select FixedTime, system will wake on the hr::min::sec specified. Select DynamicTime, System will wake on the current time + Increase minutes.

Network Stack Configuration

This section is used to configure the network stack.



Network Stack

Enable or disable UEFI network stack.

Ipv4 PXE Support

Enable or disable IPv4 PXE support. If disabled, the IPv4 boot option will not be created.

Ipv6 PXE Support

Enable or disable IPv6 PXE support. If disabled, the IPv6 boot option will not be created.

NVMe Configuration

This section is used to display information on the NVMe devices installed.



Security

This section is used to configure the security features.

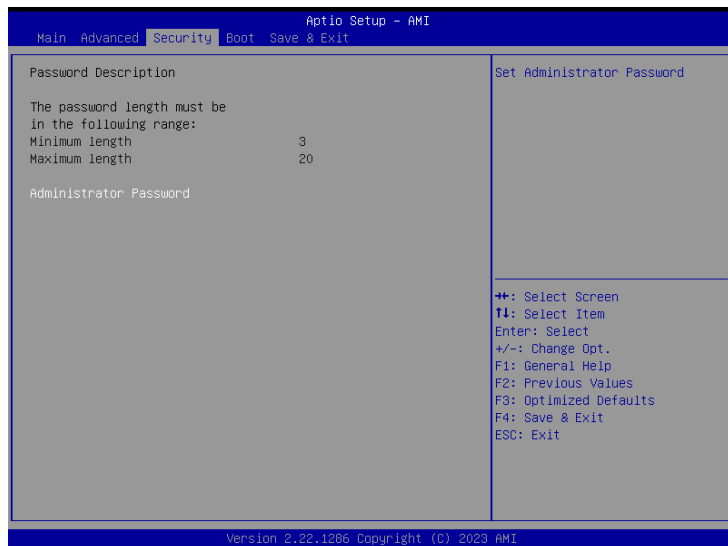

Administrator Password

Select this to configure the administrator's password.

Boot

This section is used to configure the boot features.



Bootup NumLock State

This allows you to determine the default state of the numeric keypad. By default, the system boots up with NumLock on wherein the function of the numeric keypad is the number keys. When set to Off, the function of the numeric keypad is the arrow keys.

Boot Option Priorities

Adjust the boot sequence of the system. Boot Option #1 is the first boot device that the system will boot from, next will be #2 and so forth.

Save & Exit

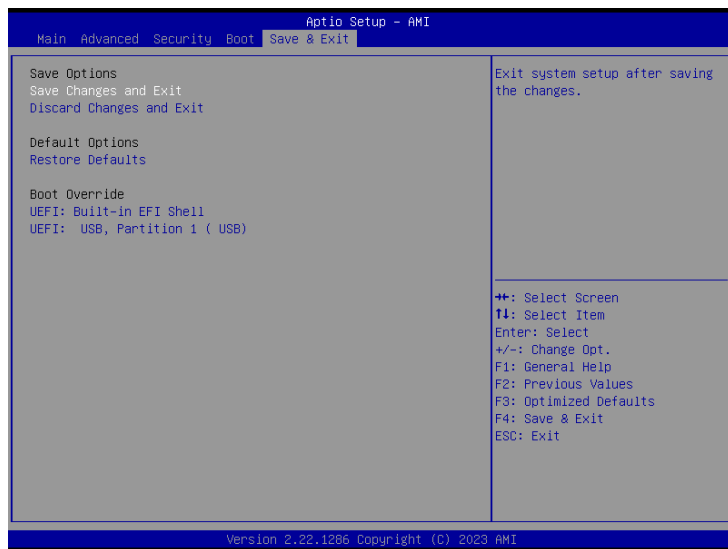

Save Changes and Exit

To save the changes and exit the Setup utility, select this field then press <Enter>. A dialog box will appear. Confirm by selecting Yes. You can also press <F4> to save and exit Setup.

Discard Changes and Exit

To exit the Setup utility without saving the changes, select this field then press <Enter>. You may be prompted to confirm again before exiting. You can also press <ESC> to exit without saving the changes.

Restore Defaults

To restore the BIOS to default settings, select this field then press <Enter>. A dialog box will appear. Confirm it by selecting Yes.

Boot Override

To bypass the boot sequence from the Boot Option List and boot from a particular device, select the desired device and press <Enter>.

APPENDIX A: NCT6126D GPIO PROGRAMMING GUIDE (PCB A)

GPIO (General Purpose Input/Output) pins are provided for custom system design. This appendix provides definitions and its default setting for the ten GPIO pins in the NDiS B561. The pin definition is shown in the following table:

Pin No.	GPIO mode	PowerOn Default	Address
1	VCC	-	-
2	GND	-	-
3	GPO0	HIGH	A02h (Bit0)
4	GPO1	HIGH	A02h (Bit1)
5	GPO2	HIGH	A02h (Bit2)
6	GPO3	HIGH	A02h (Bit3)
7	GPI0		A02h (Bit4)
8	GPI1		A02h (Bit5)
9	GPI2		A02h (Bit6)
10	GPI3		A02h (Bit7)

Control the GPO 0/1/2/3 level from I/O port A02h bit0 / A02h bit1 / A02h bit2 / A02h bit3.

The bit is Set/Clear indicated output High/Low

Read GPI 0/1/2/3 Set GPO2X

GPIO programming sample code

```
#define GPO0                (0x01 << 0)
#define GPO1                (0x01 << 1)
#define GPO2                (0x01 << 2)
#define GPO3                (0x01 << 3)
#define GPO2X                outputb(0xA00, 0x02)
#define GPO0_HI              outputb(0xA02, GPO0)
#define GPO0_LO              outputb(0xA02, 0x00)
#define GPO1_HI              outputb(0xA02, GPO1)
#define GPO1_LO              outputb(0xA02, 0x00)
#define GPO2_HI              outputb(0xA02, GPO2)
#define GPO2_LO              outputb(0xA02, 0x00)
#define GPO3_HI              outputb(0xA02, GPO3)
#define GPO3_LO              outputb(0xA02, 0x00)
void main(void)
{
    GPO2X;
    GPO0_HI;
    GPO1_LO;
    GPO2_HI;
    GPO3_LO;
}
```

APPENDIX B: NCT6126D WATCHDOG PROGRAMMING GUIDE

NiS B561 features a watchdog timer that resets the CPU or generates an interrupt if the processor stops operating for any reason. This feature ensures system reliability in industrial standalone or unmanned environments.

```
#define SUPERIO_PORT  0x2E
#define WDT_SET       0xF0
#define WDT_VALUE 0xF1

void main(void)
{
    #Enter SuperIO Configuration
        outputb(SUPERIO_PORT, 0x87);
        outputb(SUPERIO_PORT, 0x87);

    # Set LDN
        outputb(SUPERIO_PORT, 0x07);
        outputb(SUPERIO_PORT+1 ,0x08);

    # Set WDT setting
        outputb(SUPERIO_PORT, WDT_SET);
        outputb(SUPERIO_PORT+1, 0x00); # Use the second
# Use the minute, change value to 0x08
    # Set WDT sec/min
        outputb(SUPERIO_PORT, WDT_VALUE);
        outputb(SUPERIO_PORT+1, 0x05); #Set 5 seconds
}
```