

---

**M1859**  
**18.5" Fanless Intel® Celeron®**  
**Quad Core N3160**  
**Medical Infotainment Terminal**

**User's Manual**  
**Version 1.0**

P/N: 4018185900100P

2019.08



---

This page is intentionally left blank.

---

---

## Revision History

Version	Release Time	Description
1.0	2019.08	Initial release

---

## Copyright

Copyright © 2017 ARBOR Technology Corp. All Rights Reserved.

This document contains proprietary information protected by copyright. No part of this manual may be reproduced by any mechanical, electronic, or other means in any form without prior written permission of the manufacturer.

## Disclaimer

The information in this document is subject to change without prior notice in order to improve the reliability, design and function. It does not represent a commitment on the part of the manufacturer.

Under no circumstances will the manufacturer be liable for any direct, indirect, special, incidental, or consequential damages arising from the use or inability to use the product or documentation, even if advised of the possibility of such damages.

## About This Manual

This user's manual provides the general information and installation instructions for the product. The manual is meant for the experienced users and integrators with hardware knowledge of personal computers. If you are not sure about any description in this manual, consult your vendor before further handling.

We recommend that you keep one copy of this manual for the quick reference for any necessary maintenance in the future. Thank you for choosing ARBOR products.

<b>Preface</b> .....	<b>v</b>
Declaration of Conformity .....	v
CE .....	v
FCC.....	v
IEC 60601-1/EN60601-1/EN60601-1-2 .....	vi
RoHS .....	vi
SVHC / REACH .....	vii
Intended Use .....	vii
Symbol Descriptions .....	vii
Important Safety Instructions .....	vii
General Cleaning Tips .....	ix
Cleaning Tools .....	x
Recommended Cleaning Procedures .....	xi
Disposing of the Equipment.....	xi
Additional Information & Technical Support.....	xii
Warranty .....	xiii
<b>Chapter 1 Introduction</b> .....	<b>1</b>
1.1 Product Highlights.....	2
1.2 Package Contents .....	2
1.3 Ordering Information.....	3
1.3.1 Optional Accessories .....	3
1.3.2 Optional Configuration (Configure-to-Order Service).....	3
1.4 Dimensions.....	4
1.5 Specifications.....	5
<b>Chapter 2 Getting Started</b> .....	<b>7</b>
2.1 Getting to Know the Computer .....	8
2.1.1 Front View.....	8
2.1.2 Rear Side.....	10
2.1.3 Bottom Side .....	11
2.1.4 Side View .....	13
2.2 Periodic Cleaning & Disinfection.....	14
2.3 Drivers and Utilities Installation.....	15
2.3.1 CD Contents .....	16
2.3.2 Installing the Drivers & Utilities .....	16
<b>Chapter 3 Using the Computer</b> .....	<b>19</b>
3.1 Using the Function Keys.....	20
3.1.1 Using the Function Keys on Windows .....	20
3.1.2 Customizing Function Keys .....	22

# Contents

---

3.2 Using the Wi-Fi Feature .....	24
3.3 Using the Bluetooth Feature .....	26
3.4 Using the Camera Feature .....	29
3.5 Using the Smart Card Reader .....	31
3.6 Using the Barcode Scanner (CTOS) .....	33
3.6.1 Supported Barcode Formats .....	35
3.7 Using the RFID&NFC Reader (CTOS) .....	36

## **Chapter 4 BIOS .....**

4.1 Accessing the BIOS Setup Utility .....	40
4.2 Main Setup .....	41
4.3 Advanced Settings .....	43
4.3.1 CPU Configuration .....	44
4.3.2 IDE Configuration .....	45
4.3.3 Super I/O Configuration .....	46
4.4 Chipset .....	47
4.5 Boot .....	48
4.6 Security .....	49
4.7 Save & Exit .....	50

## **Appendix Optional Connections .....**

A. Installing the Handset Holder .....	54
B. Using the Handset .....	55
C. Using the Remote Controller and Nurse Call Function .....	57
C.1 Overview .....	57
C.2 Connecting the Remote Controller .....	60
C.3 Programing Your Own Remote Controller Applications .....	62

## Declaration of Conformity

### CE

The CE symbol on your product indicates that it is in compliance with the directives of the Union European (EU). A Certificate of Compliance is available by contacting Technical Support.

This product has passed the CE test for environmental specifications when shielded cables are used for external wiring. We recommend the use of shielded cables. This kind of cable is available from ARBOR. Please contact your local supplier for ordering information.

### FCC

This device complies with Part 18 of the FCC Rules. Operation is subject to the following two conditions:

1. This device may not cause harmful interference, and
2. This device must accept any interference received, including interference that may cause undesired operation.

Any changes or modifications not expressly approved by the guarantee of this device could void the user's authority to operate the equipment.

This equipment has been tested and found to comply with the limits for a Class B digital device, pursuant to Part 18 of the FCC Rules. These limits are designed to provide reasonable protection against harmful interference in a residential installation. This equipment generates, uses and can radiate radio frequency energy and, if not installed and used in accordance with the instructions, may cause harmful interference to radio communications.

However, there is no guarantee that interference will not occur in a particular installation. If this equipment does cause harmful interference to radio or television reception, which can be determined by turning the equipment off and on, the user is encouraged to try to correct the interference by one or more of the following measures:

- Reorient or relocate the receiving antenna.
- Increase the separation between the equipment and receiver.

- Connect the equipment into an outlet on a circuit different from that to which the receiver is connected.
- Consult the dealer or an experienced radio/TV technician for help.

### **IEC 60601-1/EN60601-1/EN60601-1-2**

- This product complies with the system standard IEC 60601-1 Medical Electrical Equipment Part 1: General Requirements for Safety. And therefore, the product is exclusively interconnected with IEC 60601-1 certified equipment in the patient environment.
- Equipment connected to the analog or digital interfaces of the unit must comply with the respective IEC standards (e.g. IEC 60601-1 for medical equipment). Furthermore all configurations shall comply with the current version of the standard for SYSTEMS IEC 60601-1-1.
- Everybody who connects additional equipment to the signal input part or signal output part configures a medical system, and is therefore responsible that the system complies with current version of the requirements of the system standard IEC 60601-1-1. If in doubt, consult the technical service department or your local representative.

### **RoHS**

ARBOR Technology Corp. certifies that all components in its products are in compliance and conform to the European Union's Restriction of Use of Hazardous Substances in Electrical and Electronic Equipment (RoHS) Directive 2002/95/EC.

The above mentioned directive was published on 2/13/2003. The main purpose of the directive is to prohibit the use of lead, mercury, cadmium, hexavalent chromium, polybrominated biphenyls (PBB), and polybrominated diphenyl ethers (PBDE) in electrical and electronic products. Member states of the EU are to enforce by 7/1/2006.

ARBOR Technology Corp. hereby states that the listed products do not contain unintentional additions of lead, mercury, hex chrome, PBB or PBDB that exceed a maximum concentration value of 0.1% by weight or for cadmium exceed 0.01% by weight, per homogenous material. Homogenous material is defined as a substance or mixture of substances with uniform composition (such as solders, resins, plating, etc.). Lead-free solder is used for all terminations (Sn(96-96.5%), Ag(3.0-3.5%) and Cu(0.5%)).



## SVHC / REACH

To minimize the environmental impact and take more responsibility to the earth we live, ARBOR hereby confirms all products comply with the restriction of SVHC (Substances of Very High Concern) in (EC) 1907/2006 (REACH –Registration, Evaluation, Authorization, and Restriction of Chemicals) regulated by the European Union.

All substances listed in SVHC < 0.1 % by weight (1000 ppm)

## Intended Use

This product is intended for use in a medical system.

## Symbol Descriptions



This “CAUTION” symbol indicates that there is a danger of injury to the user or a risk of damage to the product, should warning notices be disregarded.



Battery Recycle



This symbol of “Electrical Safety” indicates electrical warning of specific electrical hazards.



Refer to the user manual for more information.

## Important Safety Instructions

Read these safety instructions carefully:

1. Read all cautions and warnings on the equipment.
2. Place this equipment on a reliable surface when installing. Dropping it or letting it fall may cause damage
3. Make sure the correct voltage is connected to the equipment.

4. To avoid risk of electric shock, this equipment must only be connected to a supply mains with protective earth.
5. For pluggable equipment, the socket outlet should be near the equipment and should be easily accessible.
6. Keep this equipment away from humidity.
7. Disconnect this equipment from the A/C outlet before cleaning it. Use a moist cloth. Do not use liquid or sprayed detergent for cleaning.
8. To fully disengage the power to the unit, please disconnect the power from the AC outlet.
9. Do not scratch or rub the screen with a hard object.
10. Never use any of the solvents, such as Thinner Spray-type cleaner, Wax, Benzene, Abrasive cleaner, Acid or Alkaline solvent, on the display. Harsh chemicals may cause damage to the cabinet and the touch sensor.
11. Remove dirt with a lightly moistened cloth and a mild solvent detergent. Then wipe the cabinet with a soft dry cloth.
12. The openings on the enclosure are for air convection and protect the equipment from overheating. **DO NOT COVER THE OPENINGS.**
13. Position the power cord so that people cannot step on it. Do not place anything over the power cord.
14. If the equipment will not be used for a long time, disconnect it from the power source to avoid damage by transient overvoltage.
15. Never pour any liquid into openings. This may cause fire or electrical shock.
16. Never open the equipment. For safety reasons, the equipment should be opened only by qualified service personnel.
17. No modification of the equipment is allowed.
18. Only personnel authorised by the manufacturer may carry out technical operations on the equipment.
19. The sound pressure level at the operator's position, according to IEC 704-1:1982, is no more than 70dB(A).
20. Keep this User's Manual for later reference.

21. DO NOT LEAVE THIS EQUIPMENT IN AN UNCONTROLLED ENVIRONMENT WHERE THE STORAGE TEMPERATURE IS BELOW  $-20^{\circ}\text{C}$  ( $-4^{\circ}\text{F}$ ) OR ABOVE  $60^{\circ}\text{C}$  ( $140^{\circ}\text{F}$ ). THIS MAY DAMAGE THE EQUIPMENT.
22. The computer comes with two DC IN jacks. DO NOT use the two DC IN jacks simultaneously.
23. If one of the following situations arises, get the equipment checked by service personnel:
  - a. The power cord or plug is damaged.
  - b. Liquid has penetrated into the equipment.
  - c. The equipment has been exposed to moisture.
  - d. The equipment does not work well, or you cannot get it to work according to the user's manual.
  - e. The equipment has been dropped or damaged.
  - f. The equipment has obvious signs of breakage.



Do not use the power adapter that isn't made for the equipment. Supplying the equipment with inappropriate voltage may cause harm to the battery (if any) or, even worse, burn the equipment.



Risk of explosion if RTC (Real-Time Clock) battery is replaced by an incorrect type. Dispose of used batteries according to the instructions.



To prevent possible hearing damage, do not listen at high volume levels for long periods.

## General Cleaning Tips

You may need the following precautions before you begin to clean the device. When you clean any single part or component for the device, please thoroughly read and understand the details below.

1. We strongly recommended that you should shut down the system before you start to clean any single components.

2. When you need to clean the device, please rub it with a piece of dry cloth.
3. Be cautious of the tiny removable components when you use a vacuum cleaner to absorb the dirt on the floor.
4. Never drop the components inside the device or get circuit board damp or wet.
5. Be cautious of all kinds of cleaning solvents or chemicals when you use it for the sake of cleaning. Some individuals may be allergic to the ingredients.
6. Try not to put any food, drink or cigarette around the device.

## Cleaning Tools

Although many companies have created products to help improve the process of cleaning your devices and peripherals, users can also use household items to clean their devices and peripherals. Below is a listing of items you may need or want to use while cleaning your devices or peripherals. Keep in mind that some components in your device may only be able to be cleaned using a product designed for cleaning that component, if this is the case it will be mentioned in the cleaning.

- **Cloth:** A piece of cloth is the best tool to use when rubbing up a component. Although paper towels or tissues can be used on most hardware as well, we still recommend you to rub it with a piece of cloth.
- **Water or rubbing alcohol:** You may moisten a piece of cloth a bit with some water or rubbing alcohol and rub it on the device. Unknown solvents may be harmful to the plastics parts.
- **Vacuum cleaner:** Absorb the dust, dirt, hair, cigarette particles, and other particles out of the device can be one of the best cleaning methods. Over time, these items can restrict the airflow in a device and cause circuitry to corrode.
- **Cotton swabs:** Cotton swaps moistened with rubbing alcohol or water are excellent tools for wiping hard to reach areas in your keyboard, mouse, and other locations.
- **Foam swabs:** Whenever possible, it is better to use lint-free swabs such as foam swabs.

---

## Recommended Cleaning Procedures

1. Close all application programs
2. Close operating software
3. Turn off the equipment
4. Remove all peripherals
5. Disconnect the power cable
6. Proceed to clean.

## Disposing of the Equipment

- **Within the European Union**



EU-wide legislation, as implemented in each Member State, requires that waste electrical and electronic products carrying the mark (left) must be disposed of separately from normal household waste.

This includes monitors and electrical accessories, such as signal cables or power cords. When you need to dispose of your display products, please follow the guidance of your local authority, or ask the shop where you purchased the product, or if applicable, follow any agreements made between yourself. The mark on electrical and electronic products only applies to the current European Union Member States.

- **Outside the European Union**

If you wish to dispose of used electrical and electronic products outside the European Union, please contact your local authority so as to comply with the correct disposal method.

## **Additional Information & Technical Support**

All ARBOR products are built to the most accurate specifications to ensure reliable performance in the harsh and demanding conditions typical of industrial environments. Whether your new equipment is destined for the laboratory or the factory floor, you can be assured that the computer will provide the reliability and ease of operation. Your satisfaction is our primary concern. We want you to get the maximum performance from the computer. So if you run into technical difficulties, we are here to help. For the most frequently asked questions, you can easily find answers in the computer's documentation. These answers are normally a lot more detailed than the ones we can give over the phone. So please consult this manual first. If you still cannot find the answer, gather all the information or questions that apply to your problem, and with the product close at hand, call your dealer. Our dealers are well trained and ready to give you the support you need to get the most from the computer. In fact, most problems reported are minor and are able to be easily solved over the phone. We are always ready to give advice on application requirements or specific information on the installation and operation of any of our products. Do not hesitate to contact us using the following contact information:

Website: <http://www.arbor-technology.com>

E-mail: [info@arbor.com.tw](mailto:info@arbor.com.tw)

TEL: 886-2-8226-9396

Add: 10F., No.700, Zhongzheng Rd., Zhonghe Dist., New Taipei City 235, Taiwan

---

## Warranty

This product is warranted to be in good working order during the warranty period. Should this product fail to be in good working order at any time during this period, we will, at our option, replace or repair it at no additional charge except as set forth in the following terms. This warranty does not apply to products damaged by misuse, modifications, accident or disaster.

Vendor assumes no liability for any damages, lost profits, lost savings or any other incidental or consequential damage resulting from the use, misuse of, or inability to use this product. Vendor will not be liable for any claim made by any other related party.

Vendors disclaim all other warranties, either expressed or implied, including but not limited to implied warranties of merchantability and fitness for a particular purpose, with respect to the hardware, the accompanying product's manual(s) and written materials, and any accompanying hardware. This limited warranty gives you specific legal rights.

Return authorization must be obtained from the vendor before returned merchandise will be accepted. Authorization can be obtained by calling or faxing the vendor and requesting a Return Merchandise Authorization (RMA) number. Returned goods should always be accompanied by a clear problem description.

---

This page is intentionally left blank.



---

# Chapter 1

## Introduction

## 1.1 Product Highlights

The medical infotainment terminal, M1859, is designed for patient care and bedside infotainment. With low power consumption Intel® Celeron N3160 processor and fanless design, the computer is suitable for the uses in hospitals and clinics. The M1859 is also an entertainment and information terminal for patients during their stay in hospital. The 18.5" touch screen, definable function keys and abundant expansions make it more convenient for clinicians and patients to operate. For networking, the M1859 supports Bluetooth and WLAN, which gives it great accessibility for eHealthcare medical care. Other integrated vertical application functions include 1D/2D barcode scanner, 5.0 megapixel camera, RFID & NFC reader and smart card reader.



- Flush front bezel ID design
- Windows fanless medical terminal with Celeron N3160
- 18.5" LCD with 10-point projected capacitive multi-touch
- Applicable for bedside infotainment and self-registration
- IEC60601-1 (3rd edition), EN60601-1 (3rd edition), EN60601-1-2 certified
- Ventless design, water-proof and dust resistant
- Patient identification through integrated RFID & NFC, barcode scanner and smart card reader

## 1.2 Package Contents

Upon opening the package, carefully inspect the contents. If any of the items is missing or appears damaged, contact your local dealer or distributor. The package should contain the following items:



1 x M1859



1 x User's manual  
1 x Driver CD



1 x 65W medical-grade AC/DC adapter kit

---

## 1.3 Ordering Information

**M1859**

18.5" fanless Intel® Braswell N3160 Medical PC with flush-mounted projected capacitive multi-touch screen

### 1.3.1 Optional Accessories

The following items are normally optional, but some vendors may include them as a standard package, or some vendors may not carry all the items.



Phone-1858

VoIP phone with RJ-11 cable

---



RC-185X

Remote controller with DB-9 cable

---

### 1.3.2 Optional Configuration (Configure-to-Order Service)



RFID & NFC-1858

RFID & NFC module kit

---



BarC-1858

Barcode scanner module kit

---

## 1.4 Dimensions

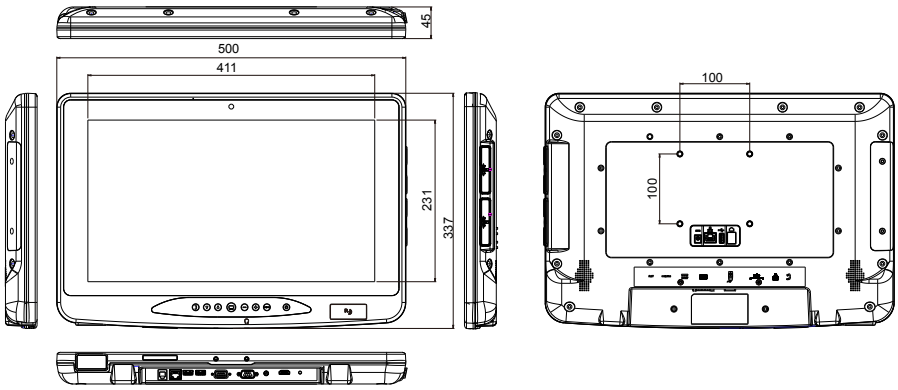

Unit:mm

## 1.5 Specifications

<b>System</b>	
CPU	Intel® Celeron® Quad Core N3160 1.6 GHz
Memory	Soldered onboard 4GB DDR3L
Storage	32GB mSATA SSD installed
<b>Peripherals and Devices</b>	
Camera	1 x 5.0 MP front-facing CMOS camera with auto-focus
WLAN & Bluetooth	1 x WLAN 802.11 a/c & Bluetooth 4.0 BLE, class 2
RFID & NFC	1 x 13.56MHz RFID & NFC reader with ISO 14443A/14443B/15693/Mifare support (optional)
Smart Card Reader	2 x Smart Card Reader slots
Barcode Scanner	1 x 1D/2D barcode scanner (optional)
Phone	1 x VoIP phone blower (optional)
Remote Controller	1 x Remote controller with VoIP phone & nurse call function (optional)
Light Bar	1 x Light bar (Orange/White)
<b>I/O Interface</b>	
Audio	2 x 3W speakers, 1 x built-in microphone (both w/ amplifier)
	1 x Mic-in, 1 x speaker-out on bottom Line
LAN	2 x RJ-45 GbE connectors (One on the bottom line, and the other on the rear panel.)
Serial Port	1 x RS-232 port on bottom Line (DB-9 connector)
USB Port	2 x USB 3.0 ports
	1 x USB 2.0 port
HDMI	1 x HDMI in port
<b>Button &amp; Indicator</b>	
Button	1 x Power on/off button    1 x Menu button
	1 x Brightness up button    1 x Brightness down button
	1 x LCD on/off button    1 x Volume up button
	1 x Volume down buton    1 x Phone on/off button

<b>Touch Screen</b>	
Type	10-point Projected Capacitive Multi-Touch
Light Transparency	80% (typ.)
Controller Interface	LVDS type
<b>LCD Display</b>	
Size/Type	18.5" TFT color LCD
Max. Resolution	1366 x 768 (WXGA) with 16.7M colors
Luminance	250 cd/m <sup>2</sup> (typ.)
Contrast Ratio	1000 : 1 (typ.)
Backlight Type	LED
View Angle (H/V)	160°/170° (typ.)
<b>Power Requirement</b>	
Adapter Input	100 ~ 240 VAC (full range)
Adapter Output	DC 20V, 3.25A, 65W (Max.) with medical certificate
<b>Mechanical &amp; Environmental</b>	
Operating Temp.	0 ~ 40°C (32 ~ 104°F)
Storage Temp.	-20 ~ 60°C (-4 ~ 140°F)
Operating Humidity	10 ~ 95% @ 40°C (non-condensing)
Dimensions (W x H x D)	500 x 337 x 45 mm (19.69" x 13.27" x 1.77")
Net Weight	5 kg (11.02 lb)
Vibration	1 Grms/ 5 ~ 500Hz/ random operation
Shock	Operating: 10G/peak (11ms) Non-operating: 10G/peak w/ SSD
Mounting	VESA-100 compatible (M6)
IP Rating	Compliance design with IP65 (front touch panel)
Operational Altitude	Below 2000m
Regulatory	CE, FCC Class B
	IEC60601-1 (3rd edition), EN60601-1 (3rd edition), EN60601-1-2
OS Support	
Windows Embedded 8.1 Industry Pro	
Linux: Ubuntu	

---

# Chapter 2

## Getting Started

## 2.1 Getting to Know the Computer





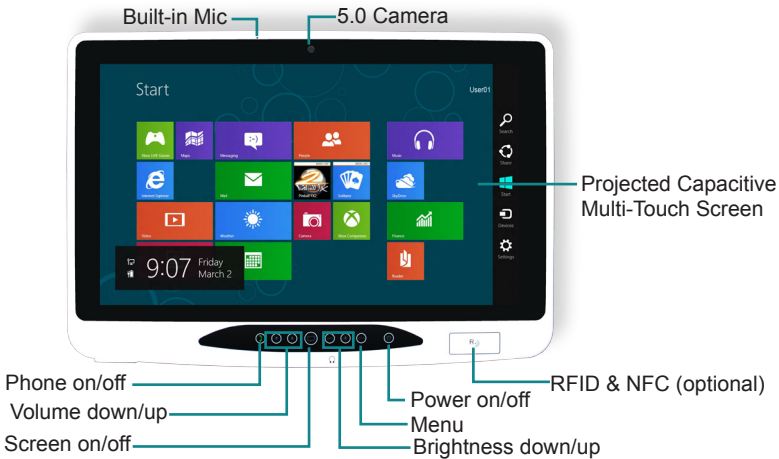

Understanding the computer helps you jump seamlessly from component to component when using the computer. This section will quickly familiarize you with the computer.

### 2.1.1 Front View



Function Key	Graphic	Default Function
Power on/off		<p><b>Power on/off button</b></p> <ul style="list-style-type: none"> <li>▶ To turn on the computer: Press the button for about 3 seconds to turn on the computer.</li> <li>▶ To force shut down the computer: Press the button for about 10 seconds to force shut down.</li> <li>▶ To put the computer into hibernate or sleep mode: Press the button for about 3 seconds until the LCD screen turns off.</li> <li>▶ To wake the computer from hibernate or sleep mode: Press the button until the LCD screen turns on.</li> </ul> <p><b>Note:</b> The default action for the <b>Power</b> button in Windows 7 is sleep. To change the action, tapping <b>Start &gt; Control Panel &gt; Power Options &gt; Power button action</b>.</p>



Function Key	Graphic	Default Function
Power on/off		<p><b>Power Status LED</b></p> <ul style="list-style-type: none"> <li>▶ <b>Off:</b> The power is turned off.</li> <li>▶ <b>Lights green:</b> The computer is turned on.</li> <li>▶ <b>Lights amber:</b> The computer is in sleep/hibernate mode.</li> </ul>
Menu		Launches the ARBOR TabletUI utility.
Brightness up/down		Increases/decreases display backlight brightness.
Volume up/down		Increases/decreases system volume.
Screen on/off		<p>Press 1 second to turn on/off the display</p> <p>Press 3 seconds to switch into HDMI</p> <p>Press 3 seconds to switch back to M1859.</p>
Phone on/off		<p>Turns on/off the phone handset audio.</p> <p><b>Note:</b> Phone handset function is disabled by default. To enable this function, enter the BIOS to enable “Phone Button Configuration” under the <b>Advanced</b> menu. See <a href="#">Chapter 4 BIOS &gt; 4.3 Advanced Settings</a> on page <a href="#">43</a> for details.</p>

**Caution:** To power off the power completely, disconnect the plug of the AC power cord from the electrical outlet only when the power LED lights amber. If you disconnect it while the power LED lights green, data might be lost or corrupted, and the system might be damaged.

## 2.1.2 Rear Side

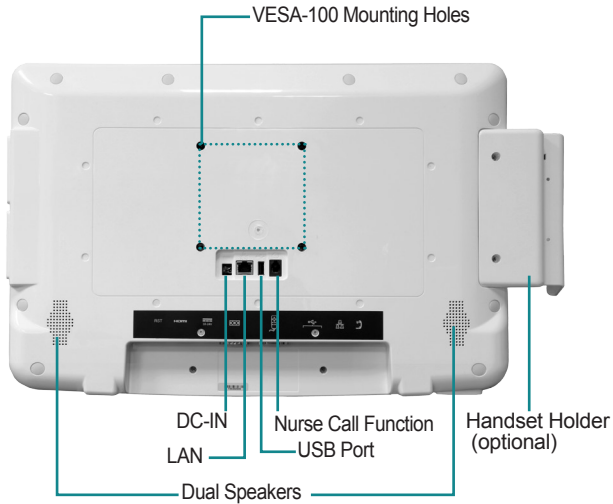

Item	Descriptions
VESA 100 mounting holes	To attach VESA 100-compatible mounting kit using M6 x 40 screws. <b>Warning:</b> DO NOT use the VESA 75 mounting holes, or you might risk the danger of damaging the computer.
DC-IN	DC-IN Power jack. To connect the computer to a power source through provided AC power adapter. <b>Warning:</b> The computer comes with another DC IN jack on the bottom side. Use either of the DC IN jacks. DO NOT use the two DC IN jacks simultaneously.
LAN	Gigabit Ethernet port. To connect the computer to a network through an Ethernet cable.
Nurse Call Function	RJ-11 connector. To connect to a nurse call system. For more information on using the nurse call function, refer to <a href="#">C. Using the Remote Controller and Nurse Call Function</a> on page 57.
USB Port	USB 2.0 Type-A port. To connect to USB device
Dual Speakers	Integrated 3W stereo speakers for audio output.

Item	Descriptions
Handset Holder	Optional handset holder. See <a href="#">A. Installing the Handset Holder</a> for details.

**Warning:** The computer's rear plate is highly heated when the computer is operating. As the temperature might reach up to 60°C (140°F), DO NOT touch the rear plate during operating.



### 2.1.3 Bottom Side

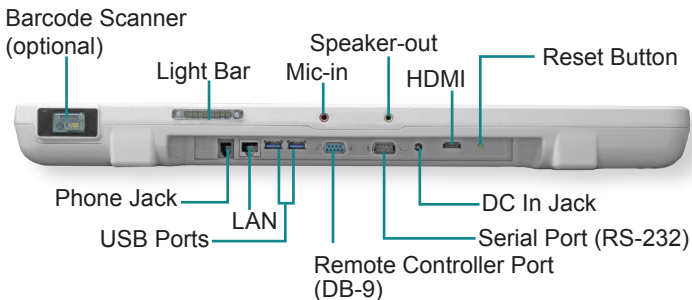

Item	Descriptions
Barcode Scanner	1D/2D barcode scanner (optional).
Light Bar	Flashes in orange on incoming calls. Lights in white when turned on via the function key panel. Refer to <a href="#">3.1 Using the Function Keys</a> for details.

## Getting Started

---

Item	Descriptions
Mic-in	To connect to a microphone to capture sound and voice when used with a program capable of recording audio.
Speaker Out	3.5mm phone jack. To connect to a headphone for audio output.
Reset Button	Press to reset the computer
Phone Jack	RJ-11 phone jack. To connect to a phone handset (optional).
LAN	Gigabit Ethernet port. To connect the computer to a network through an Ethernet cable.
USB Ports	USB 3.0/2.0 Type-A port. To connect to USB device(s).
Remote Controller Port	DB-9 serial port. To connect to the optional remote controller through provided DB9-to-RJ45 cable. For more information on using the remote controller, refer to <a href="#">C. Using the Remote Controller and Nurse Call Function</a> on page 57.
Serial Port	RS-232 serial port. To connect to a serial device.
DC In	DC-IN Power jack. To connect the computer to a power source through provided AC power adapter. <b>Warning:</b> The computer comes with another DC IN jack on the rear side. Use either of the DC IN jacks. DO NOT use the two DC IN jacks simultaneously.
HDMI	HDMI input port. To connect to an HDMI output port of video source equipment.

## 2.1.4 Side View

Item	Descriptions
Smart Card Reader Slots	Dual smart card reader slots with hinged rubber cover. Allows to insert a smart card.

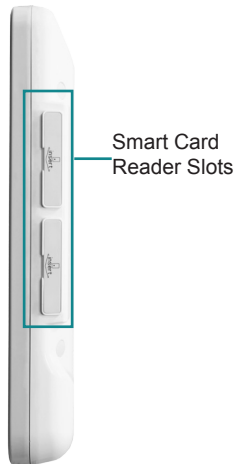

## 2.2 Periodic Cleaning & Disinfection

This medical computer is generally employed in medical environment, for example, hospitals, as bedside infotainment. It is strongly recommended that users follow the cleaning and disinfection instructions described below to ensure proper maintenance activities.

1. Always power off your unit first when you clean or disinfect it.
2. To wipe the outer case, use lint-free cloth, lightly moistened with warm water and a mild, non-abrasive cleaning solution made of either:
  - 70% isopropyl alcohol
  - 10% bleach solution
  - Dimethyl ethylbenzyl ammonium chlorides 0.125%, dimethyl benzyl ammonium chlorides 0.125%, Isopropyl alcohol 14.850% (Sani-Cloth®)
  - Isopropanol 17.2%; Diisobutylphenoxyethyl dimethyl bezyl ammonium chlorides 0.28% (CaviCide®)
3. The touch screen can be wiped down (e.g. to remove fingerprints) during operation using standard computer screen solution.
4. Use dry cloth to clean the rear panel and bottom, especially the areas around the connectors.



**Caution:**

- Do not spill liquids on or around the medical computer.
- Do not use other solutions than the ones mentioned above.
- Do not touch, press or rub the display panel with abrasive cleaning compounds, instruments, brushes, or rough-surface materials.
- Never spray cleaning liquids or foam onto the medical computer or soak it for cleaning.
- Do not use solvents to clean the unit.
- Do not clean, disinfect, or sterilize any part of the system by autoclaving or with the use of ethylene oxide gas; doing so may damage the unit.
- Never spray or squirt any type of liquid onto the medical computer; if a spray, gel or foam is needed, spray the liquid onto a cloth and then use the cloth to wipe or rub down the component.
- Always avoid contamination to minimize the need for disinfectants.
- Do not spill, spray, or squirt liquids to the power block and the power cable.

## 2.3 Drivers and Utilities Installation

The computer comes with a CD that contains device drivers as well as some programs and utilities. You need to install the drivers to activate the devices and some device-related services. Some drivers will come with driver-related programs to facilitate the application. To install the drivers and utilities, make sure to follow the instructions (e.g., the installation sequence) given in this section to proceed.

In addition, the CD includes a number of optional utilities. You may install those utilities as needed.

### 2.3.1 CD Contents

The drivers and utilities included in the provided CD are described in the table below:

Driver/Utility	Necessity	Descriptions
Chipset	Required	Install the chipset driver to the computer. Make sure to install the chipset driver before installing other drivers to prevent errors.
VGA	Required	Install the graphic driver.
LAN	Required	Install the network device driver.
Audio	Required	Install the audio driver.
WiFi	Required	Install the wireless network device driver. You may optionally install the wireless connection manager utility.
Bluetooth	Required	Install the Bluetooth device driver. You may optionally install the Bluetooth suite utility.
CCD Codec	Optional	Install the video capture/conversion tool.
RFID	Required for RFID/NFC module	Install the RFID/NFC device driver.
Smart Card	Required	Install the smart card reader driver.
Function Keys	Recommended	Install the <b>ArborFunKey</b> utility to use the functions on Windows or to customize the function keys. For more information on using the utility, refer to <a href="#">3.1 Using the Function Keys</a> on page <a href="#">20</a> .

### 2.3.2 Installing the Drivers & Utilities

Before installing the drivers and utilities, make sure to:

- Prepare a USB CD-ROM drive
- Prepare a USB keyboard or USB mouse to navigate through the installation
- Log on as an administrator
- Exit other running applications

Then follow the steps below to install the drivers and utilities.



1. The computer comes with two USB ports. Connect the USB CD-ROM drive (not provided) and the USB keyboard (or mouse) to the computer. According to your CD-ROM drive, you may need to connect it to a power supply.



USB Keyboard



USB Mouse

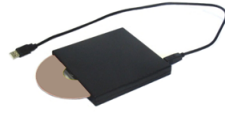

USB CD-ROM Drive

2. Insert the provided CD to the CD-ROM drive. In a few seconds, a dialog box opens asking what to do with the disc. Tap **Run AUTORUN.EXE** to auto-run the driver CD.

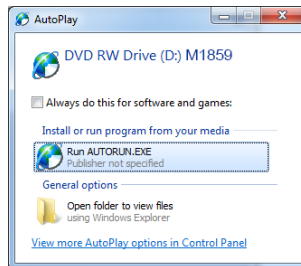

3. Tap **Driver Install**.



- 
4. The drivers menu then opens. This page is intentionally left blank.



5. Follow the sequence below to install the drivers and utilities:

**Chipset → VGA → LAN → Other Drivers / Utilities**

The installation process of each driver is basically the same. Just follow the on-screen instructions to proceed. If prompted to restart the computer, tap **Yes** to do so. In some cases, **User Access Control** will appear asking for permission to make changes to the computer. Simply tap **Yes** to continue.

---

# Chapter 3

## Using the Computer

After all drivers are installed as described in [2.3 Drivers and Utilities Installation](#) on page 15, you can start to use the computer. The chapter will walk through the essential features of the computer.

## 3.1 Using the Function Keys

### 3.1.1 Using the Function Keys on Windows

To use the function keys, you can directly press the keys on the front bezel below the LCD viewing screen. Or, you can launch the **ArborFunKey** control UI on the Windows by either of the following methods:

1. Tap the up arrow in the system tray to show the **ArborTabletui** icon.

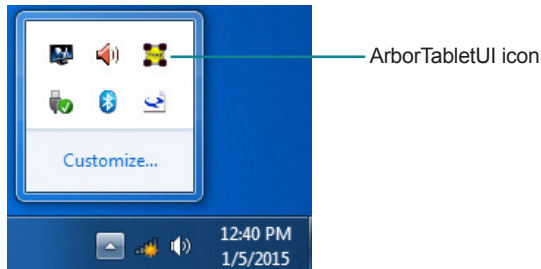





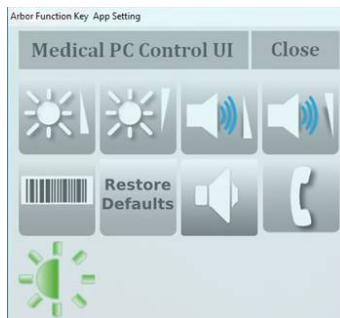



**Note:** If you didn't find the icon in the notification area, make sure the utility is running by tapping **Start > All programs > Arbor MSeries > ArborTabletui**.

2. Tap the **ArborTabletui** icon. Then the **Tablet PC Control UI** will appear on the lower right corner of the desktop.







The UI provide the following functions:

Icons	Descriptions
	To decrease LCD backlight brightness
	To increases LCD backlight brightness
	To decrease system volume.
	To increase system volume.
	To enable/disable barcode scanner (configure-to-order). Note: The barcode scanner is disabled by default and can be enabled by accessing <b>BIOS &gt; Advanced</b> .
	To mute/enable system audio.
	To restore the defaults. The volume and LCD brightness will be restored to the default levels, and all customized function keys will restore to the default functions.
	To test the incoming call function. When pressed, the speaker rings and the light bar will flash in orange.
	To turn on/off the light bar (in white) and adjust the light brightness.
Close	To exit the Tablet PC Control UI.

### 3.1.2 Customizing Function Keys

Using the **ArborTabletUI**, you can also customize the function keys as needed. The keys you can re-assign a function include **Phone, Down, Up** and **Menu**. Other keys cannot be re-assigned with new functions.

The table below summarizes the keys you can customize and the default functions:

Graphic	Name	Default Function
	PHONEONHOOK PHONEOFFHOOK	With the phone function being disabled in BIOS, no function is available to the key. With the phone function being enabled in BIOS, press the key to toggle the phone on/off.
	DOWN	To decrease system volume.
	UP	To increase system volume.
	MENU	To show Tablet PC Control UI.

To customize your own function keys:

1. Tap the up arrow in the system tray to show the **ArborTabletui** icon.

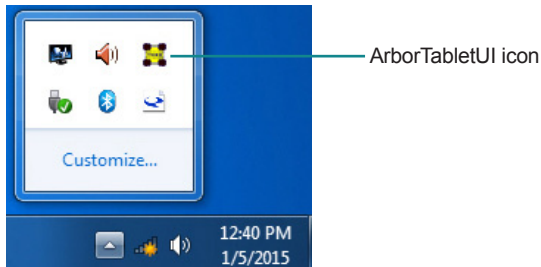

**Note:** If you didn't find the icon in the notification area, make sure the utility is running by tapping **Start > All programs > Arbor MSeries > ArborTabletui**.

2. Tap and hold the icon to display the context menu and select **Set Function Keys**.

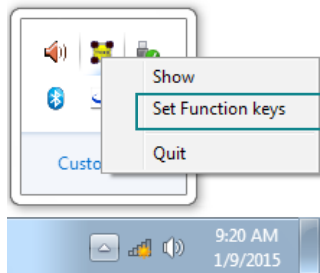

3. For the key that you want to customize its function, tap the drop-down list to choose a new function. Available functions include: **Brightness Up**, **Brightness Down**, **Volume Up**, **Volume Down**, **Show TabletUI**, **Show OnScreenKeyboard**, **Read Barcode**, **Toggle Phone On** and **Toggle Phone Off**.

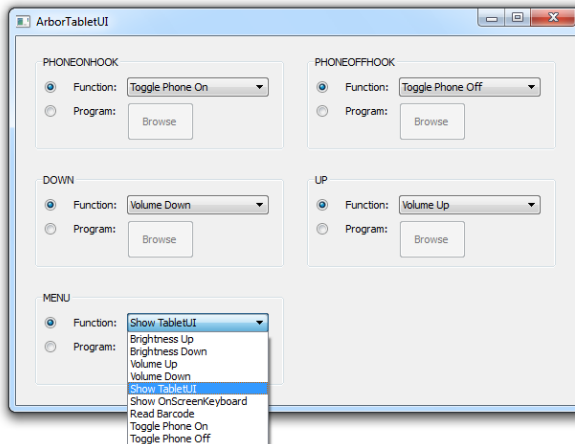

Or, you can select **Program** and then tap **Browse** to specify an application that you want to associate with the key.

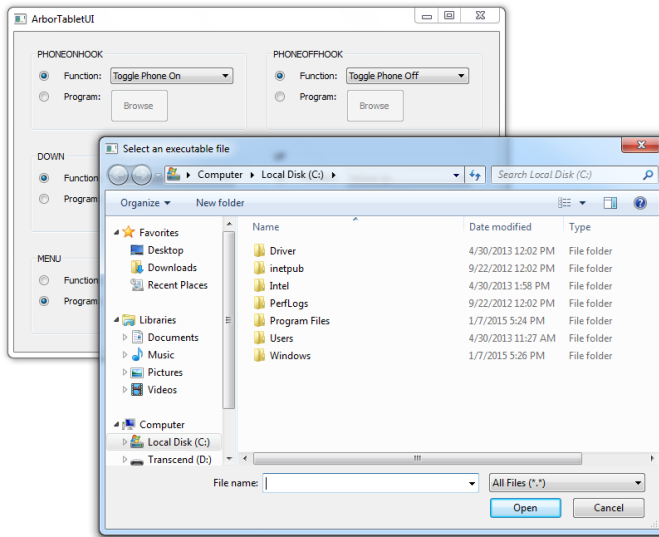



4. The settings take effect immediately. If you want to restore the defaults for all the keys, launch the **Tablet PC Control UI** and then tap **Restore Defaults**.

## 3.2 Using the Wi-Fi Feature

The computer comes with a built-in Wi-Fi module for Wi-Fi networking. Once the driver is installed as described in [2.3 Drivers and Utilities Installation](#) on page [15](#), the **Qualcomm Atheros Wireless Network Connection Manager Utility** is also installed on your computer for you to manage the wireless connections.

Alternatively, you can use the **Windows Wireless Utility Manager** to manage your wireless connection as described below.

1. Tap the network icon (  or  ) in the system tray.
2. A list opens and shows the Wi-Fi hotspots available within the wireless coverage of the computer.



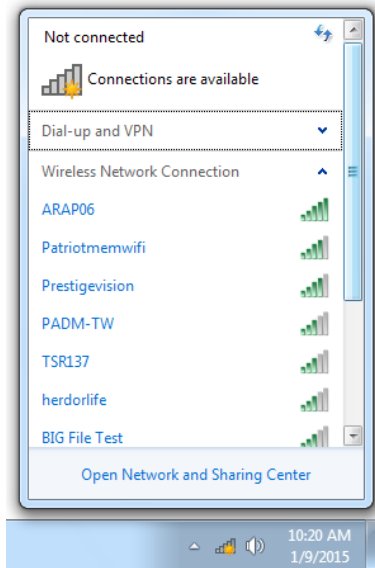

3. Tap the desired network to connect to it.

If the network to connect is a secured network, a dialog box will open and request for the password. Enter the password to access the Wi-Fi network. If it is an open network, it will be connected in a few seconds.

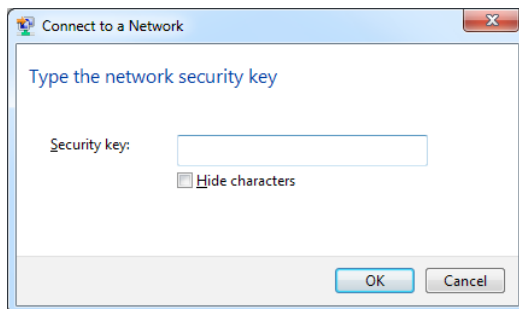

4. When the computer is connected to a Wi-Fi network, “Connected” will be displayed and the Wi-Fi signal strength icon in the notification area changes to .

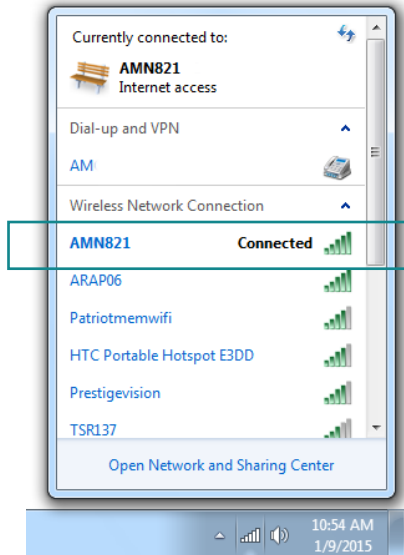

### 3.3 Using the Bluetooth Feature

Bluetooth enables the wireless connection over a short distance about 8 meters. It is specified as a “wireless personal area network” (WPAN). The computer is Bluetooth-enabled to synchronize data with other Bluetooth-capable devices such as PCs, laptops, hands-free, headsets, printers, PDAs and cell phones.

Once the Bluetooth driver is installed as described in [2.3 Drivers and Utilities Installation](#) on page 15, a Bluetooth utility, **BlueSoleil**, is also installed on your computer. To connect to a Bluetooth device using the utility, follow the steps below to proceed:

1. Tap the up arrow in the system tray to show the **Bluetooth** icon.

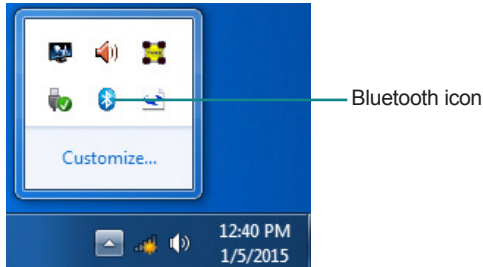

2. Tap and hold the icon to display the context menu and select **Add a Device**.

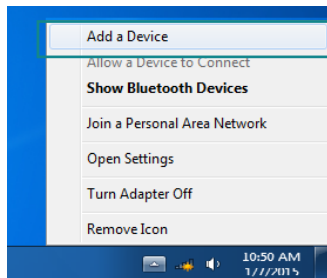

3. Select the device you want to pair and click **Next** to proceed.

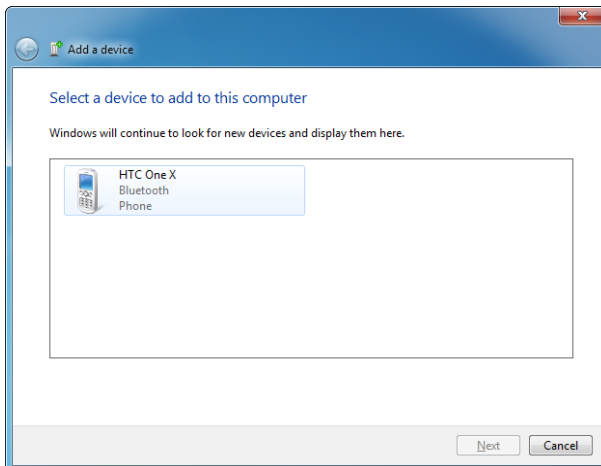

4. Check the pair code on the device you want to pair and click **Next** to proceed.

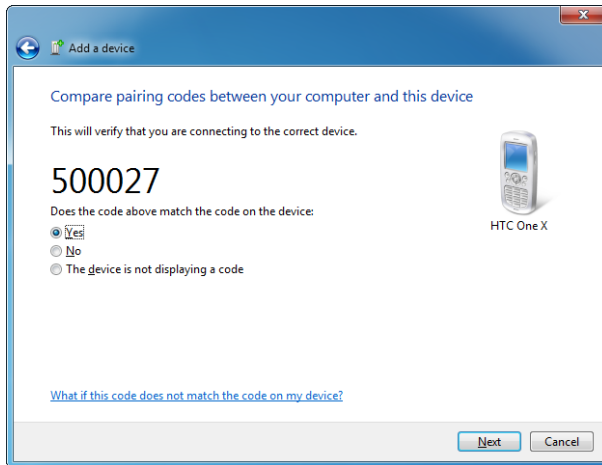

5. The device has been added to this computer. To setup the device, click the Bluetooth icon on the system tray and select **Show Bluetooth Devices** to proceed.

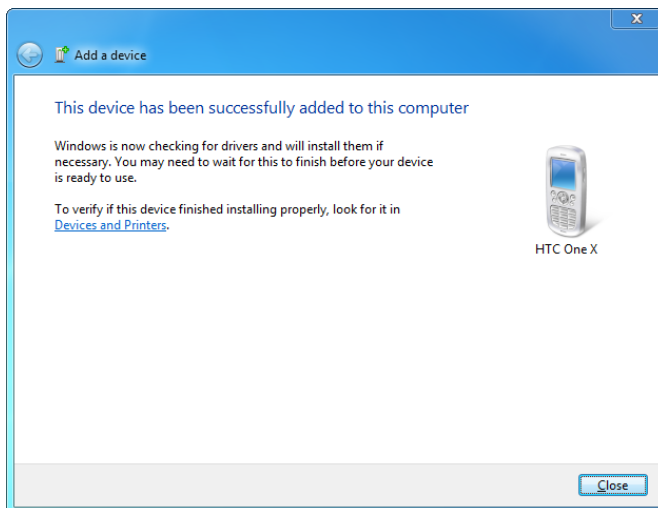

### 3.4 Using the Camera Feature

The computer comes with a ready-to-use camera without the need to install additional drivers. You can use Windows or third-party camera utility with the camera to take pictures, record videos or participate in a video conference. Or, alternatively you can use the **LEAD MULTIMEDIA CONVERTER** camera utility, which is installed when you install the camera driver, to test if the camera functions properly. To launch and use the **LEAD MULTIMEDIA CONVERTER** camera utility:

1. Tap **Start > All programs > LEAD Converter > LEAD Converter**.
2. Tap the upper-left corner to switch to **Capture** mode.

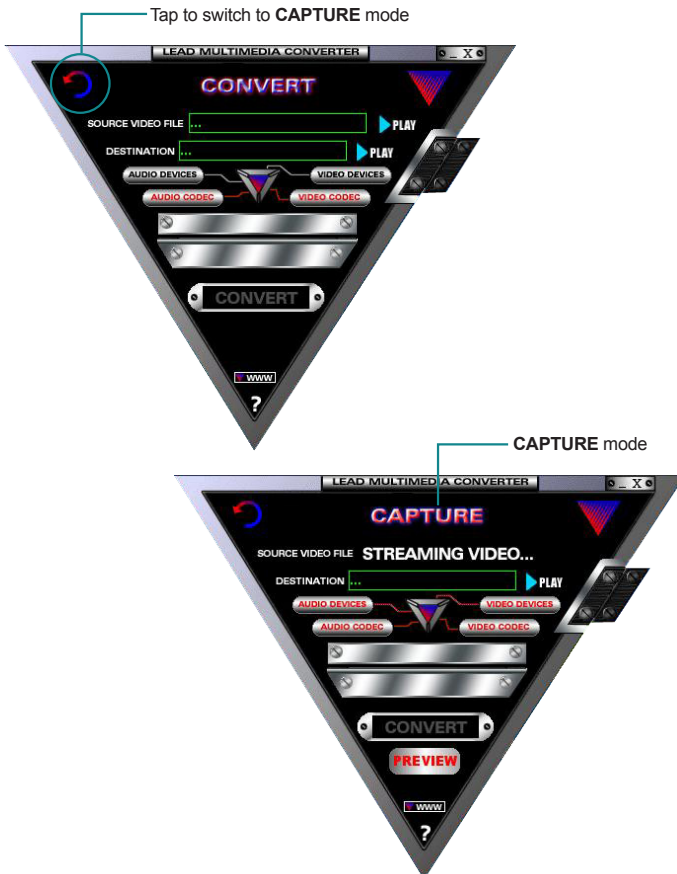

3. Set the destination for saving the recorded video. Tap the **DESTINATION** box to select a folder and specify a name for the video. Then tap **PREVIEW**.

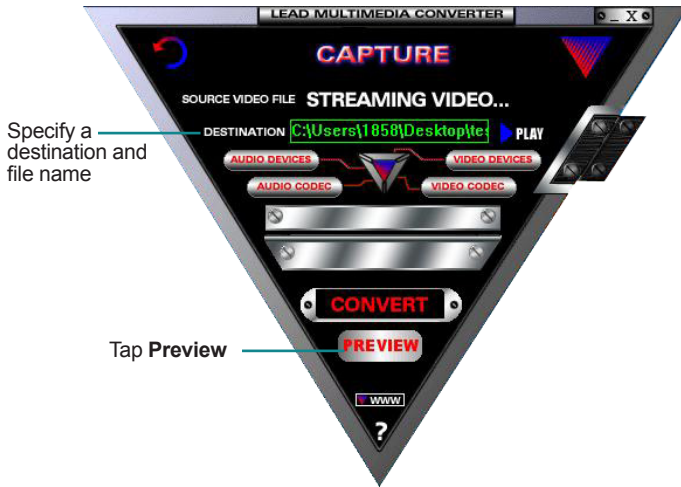

4. A video preview window will pop up showing the video that the CCD camera is recording.

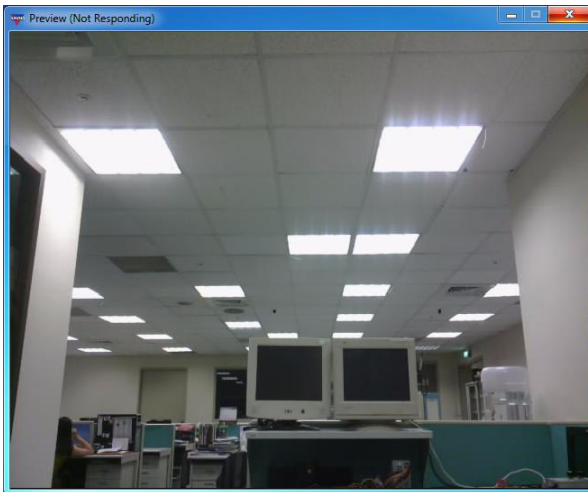

### 3.5 Using the Smart Card Reader

The computer is equipped with one smart card reader with a hinged rubber cover, allowing users to provide identification and information using a smart card.

You may use your own Smart Card Reader application. However, you can optionally use the test program included in the driver CD to test if the smart card readers function properly. To use the test program,

1. Execute the file **DEMO4.exe** from the following path:  
disk drive:\Windows 7\SmartCardReader Driver\
2. Insert a smart card into the card reader that you want to test with the golden chip facing you.

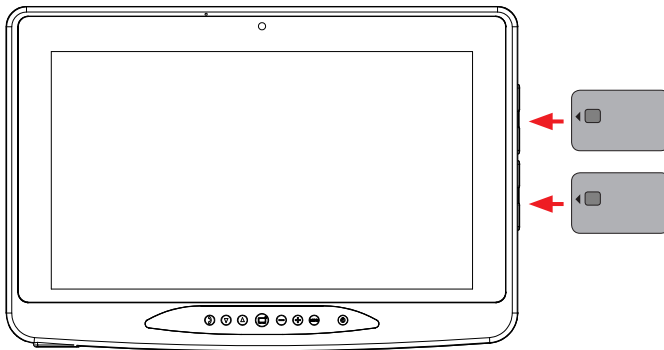

3. Tap **Select reader**. Detected reader will be displayed in the **Select Reader** dialog box. Select the reader that you want to test and then tap **OK**.

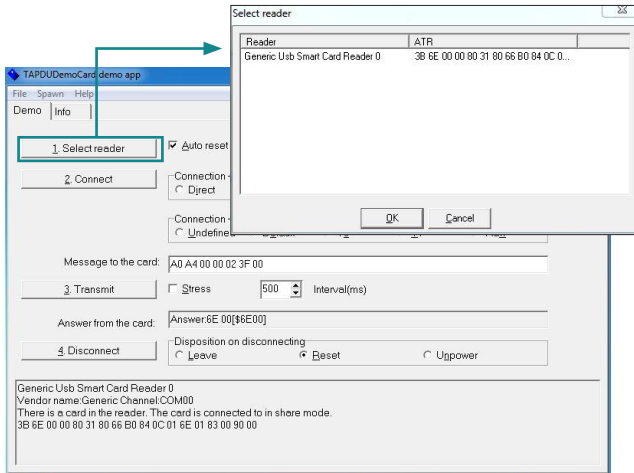

4. Tap **Connect** to proceed. If a smart card is successfully detected, its information will be displayed.

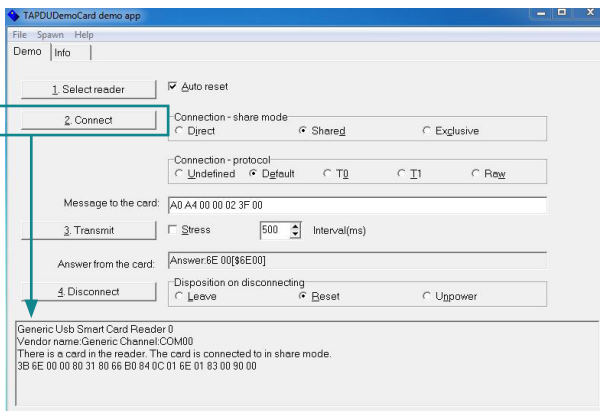



## 3.6 Using the Barcode Scanner (CTOS)

The barcode scanner is a Configure-to-Order Service (CTOS) on the computer and it is disabled by default. To use it, you must enable it in BIOS. Once enabled, it can be triggered by the barcode scanner button in the **Tablet PC Control UI**. You can also customize a function key using the **Arbor Tablet UI**. This section will walk you through the basic operations of the barcode scanner. To get the information on supported barcode formats, see [3.6.1 Supported Barcode Formats](#) on page 35 for details.

1. To use the barcode scanner, enter **BIOS > Advanced** and enable the device first since the device is disabled by default.

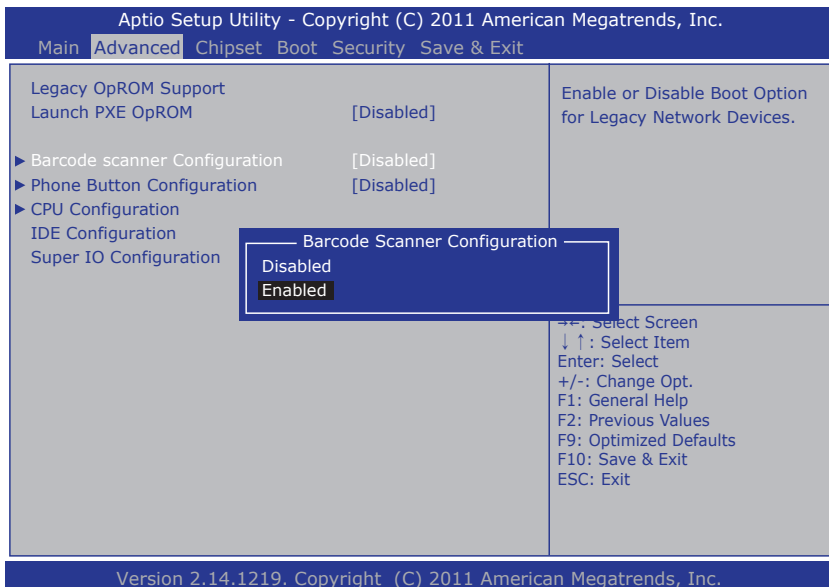

2. Launch your barcode own application. Or, if you simply want to perform a test:
  - To scan a 1D barcode: Launch a text editor, e.g., Windows Notepad.
  - To scan a 2D barcode: Launch a web browser.

3. Trigger the barcode scanner by using the barcode scanner button in the **Tablet PC Control UI** or a function key you specified. (Refer to [3.1 Using the Function Keys](#) on page 20).

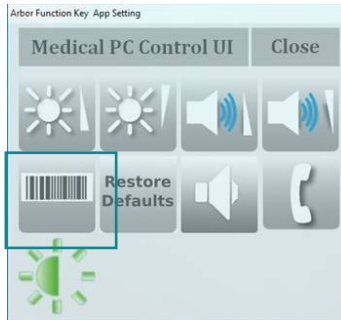

**Note:** The scanning light will stay on for 12 seconds. If no barcode is within the reach of the scanning light and no barcode is read within the 12 seconds, the scanning light will auto-stop when 12 seconds elapse.

4. Position a test barcode a few inches from the scanner as the picture below shows.



5. According to the barcode scanned, the scanned data is displayed in the text field (1D barcode) or an action is triggered (2D barcode)

### 3.6.1 Supported Barcode Formats

Linear	Matrix
BC412 (requires end-user license from IBM)	Aztec
China Post	Chinese Sensible Code (Han Xin Code)
Codabar (NW7)	Data Matrix
Code 11	Grid Matrix Code
Code 128	MaxiCode
Code 32	QR Code
Code 39	Micro QR Code
Code 93 and 93i	Postal
Code 2 of 5	Intelligent Mail Barcode
EAN	(formerly 4-state customer barcode)
Interleaved 2 of 5	Australian Post
Label Code	British Post
Matrix 2 of 5	Canadian Post
MSI	ID-tag (UPU 4-state)
Plessey	Japanese Post
PosiCode	Netherlands (KIX) Post
GS1 DataBar (formerly RSS)	Korea Post
Telepen	Planet Code
Trioptic Code	Postnet
UPC	OCR
Stacked	OCR-A
Codablock F	OCR-B
Code 16K	OCR MICR (E 13 B)
Code 49	
GS1 Composite (formerly EAN/UCC)	
MicroPDF417	
PDF417	
TCIF Linked Code 39 (TLC39)	

### 3.7 Using the RFID&NFC Reader (CTOS)

The RFID&NFC reader is a Configure-to-Order Service (CTOS) on the computer and can be identified by a label on the lower right corner of the front bezel.

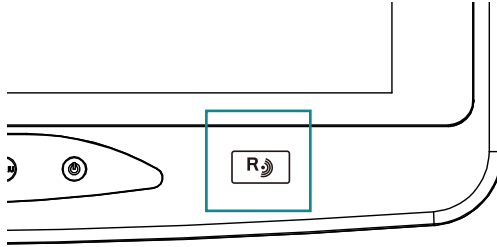

Once the driver for the RFID&NFC reader is installed, then it is ready for use. You may use your own RFID&NFC application. However, you can optionally use the test program included in the driver CD to test if the reader functions properly.

To use the test program, firstly you have to identify the COM port used by the RFID&NFC module by using the **Device Manager** on Windows. To do so, tap **Start > Control Panel > Hardware and Sound > Device Manager**. Expand the **Ports (COM & LPT)** section and locate the **Silicon Labs CP210x USB to UART Bridge** to identify the COM port.

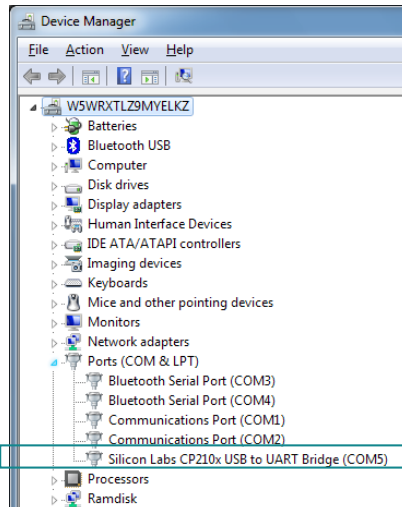

Then you may proceed to use the test program:

1. Execute the file **Jogtek.exe** from the following path:  
disk drive:\Driver\RFID\Jogtek
2. The test program then opens. On the **HF UID** tab, select and open the COM port that is used by the RFID&NFC module. Then select the card type(s) of the card you want to test.

b. Toggle it to open the port

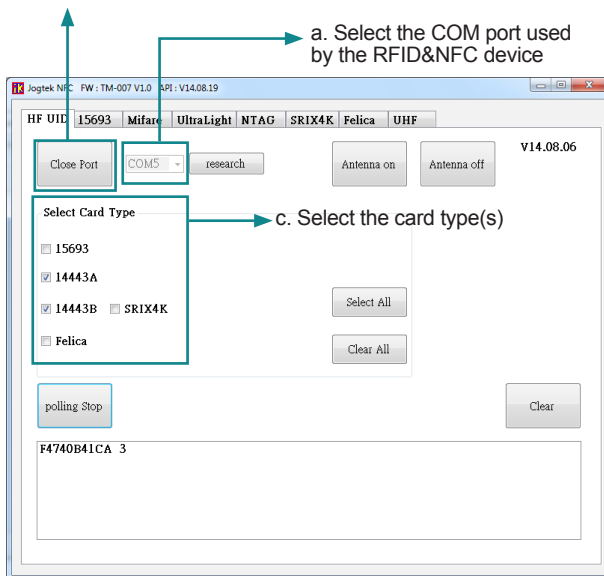

3. Tap the RFID/NFC card to the reader.

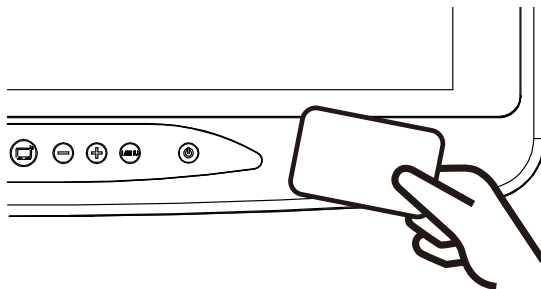

4. Then read and decoded data will be displayed.

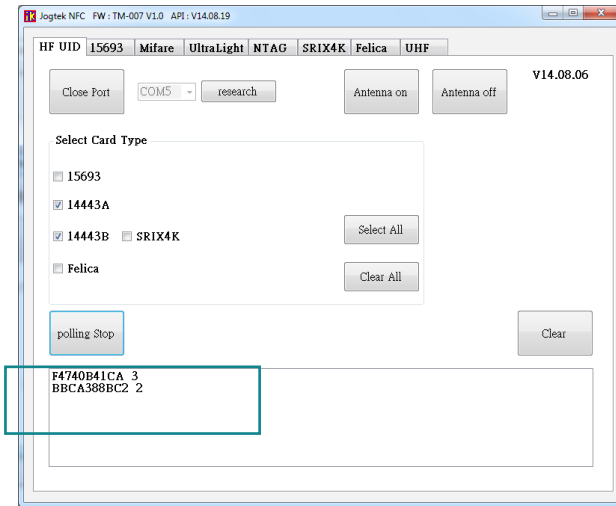

---

# Chapter 4

## BIOS

A BIOS (Basic Input/Output System) is a special utility usually stored in the ROM on the motherboard inside a computer. When you turn on the computer, the BIOS is immediately activated. During the startup, it checks and loads necessary information to ensure the computer can proceed with loading the operating system. The BIOS Setup Utility is typically accessed with a special key sequence, such as “Delete” or “Esc” key as soon as the computer is powering up.

Once you have entered the BIOS, you can get some system information and configure some hardware parameters. In most cases, there will be no need to make adjustments to the BIOS. The default settings apply to most applications and provide optimal performance.

---

**Caution:** If you need to make any change, be careful when making changes to the BIOS. Incorrect settings can cause system boot failure or malfunction.

---

**Note:** For system stability and performance, this BIOS utility is constantly improved. The screenshots demonstrated and descriptions hereinafter are for reference only and may not exactly meet what is presented on-screen.

### 4.1 Accessing the BIOS Setup Utility

To enter and use the BIOS Setup Utility, prepare a USB keyboard first and then:

1. Connect the USB keyboard to the computer first.
2. Power on the computer and press the “**Delete**” or “**Esc**” key immediately after powering on.
3. Then you will enter the BIOS Setup Utility and see the **Main** setup screen.

BIOS Setup Utility is mainly a key-based navigation interface. The bottom of the screen shows the keys for navigation and changing the settings. Refer to the table below for instructions on using the keys.

Keys	Descriptions
F1	Activate “General Help” screen.
← →	Move to select a particular configuration screen from the top menu bar / Move to highlight items on the screen.



Keys	Descriptions
↓ ↑	Move to select an item.
Enter	Select or enter a submenu
Esc	On the <b>Main Menu</b> – Exit the setup and not save changes into CMOS. On the <b>Sub Menu</b> – Exit current page and return to main menu.
+ / F6	Increase a numeric value.
- / F5	Decrease a numeric value.
F9	Load the optimal defaults. All settings will be set to the optimal defaults at startup.
F10	Save the changes that have been made and exit the BIOS Setup Utility.

## 4.2 Main Setup

When you first enter the BIOS Setup Utility, you will enter the **Main** setup screen. It reports basic system information and also allows you to configure the **System Date** and **System Time** settings.

The screenshot displays the 'Main' screen of the Aptio Setup Utility. The title bar reads 'Aptio Setup Utility - Copyright (C) 2011 American Megatrends, Inc.' and the menu bar includes 'Main', 'Advanced', 'Chipset', 'Boot', 'Security', 'Save & Exit'. The main content area is divided into three sections:

- BIOS Information:** American Megatrends (4.6.5.1), UEFI 2.3; PI 1.2, M1858 1.12, 0.18.
- System Date/Time:** [Tue 01/06/2015], [14:04:38].
- Access Level:** Administrator.

On the right side, there is a help text: 'Set the Date. Use Tab to switch between Date elements.' and a list of navigation keys: '←→: Select Screen', '↑↓: Select Item', 'Enter: Select', '+/-: Change Opt.', 'F1: General Help', 'F2: Previous Values', 'F9: Optimized Defaults', 'F10: Save & Exit', 'ESC: Exit'. The footer shows 'Version 2.14.1219, Copyright (C) 2011 American Megatrends, Inc.'

## BIOS

---

The **Main** setup screen provides the following information and options:

<b>Info / Item</b>	<b>Descriptions</b>
<b>BIOS Vendor</b>	Displays BIOS vendor name.
<b>Core Version</b>	Displays current core version information.
<b>Compliance</b>	Displays the compliant UEFI (Unified Extensible Firmware Interface) and PI (Platform Initialization) information.
<b>BIOS Version</b>	Displays the computer's model and the BIOS version.
<b>EC Version</b>	Displays the current version of the Embedded Controller.
<b>System Date</b>	Sets system date. Valid range is from 1 to 12, 1 to 31 and 2000 to 2099.
<b>System Time</b>	Sets system time. Valid range is from 0 to 23, 0 to 59 and 0 to 59.
<b>Access Level</b>	Displays the access level.

## 4.3 Advanced Settings

The **Advanced** screen provides you the options to configure the details of your hardware, such as the barcode scanner, phone button, CPU, IDE and Super IO (input/output).

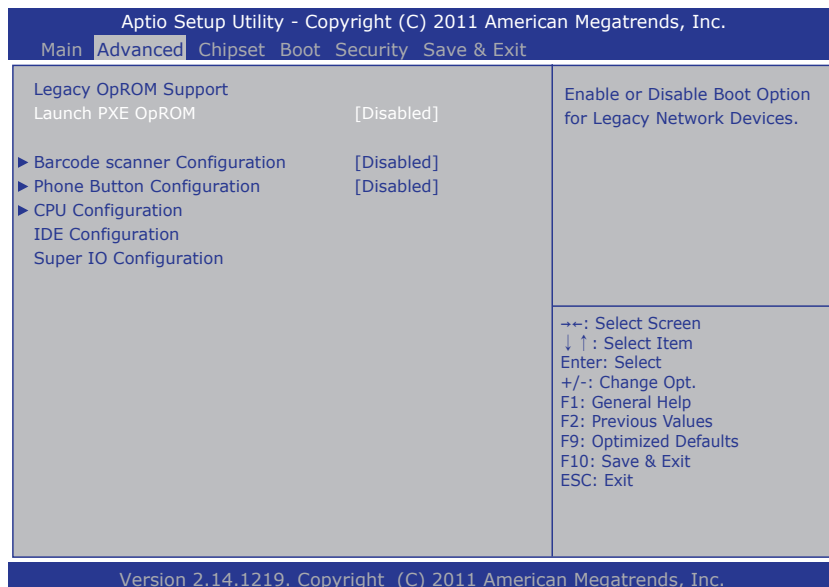

Info / Item	Descriptions
<b>Launch PXE OpROM</b>	Enables/Disables boot option for legacy network devices. Options: <b>Enabled, Disabled</b> [default] *PXE means “Preboot Execution Environment”, a series of methods to get a typical Windows-based computer to boot up without a hard drive or boot diskette.
<b>Barcode scanner configuration</b>	Enables/Disables the barcode scanner (for model with barcode scanner module). Options: <b>Enabled, Disabled</b> [default]
<b>Phone Button Configuraton</b>	Enables/Disables the phone handset function. Options: <b>Enabled, Disabled</b> [default]
<b>CPU Configuration</b>	Refer to <a href="#">4.3.1 CPU Configuration</a> on page <a href="#">44</a>
<b>IED Configuration</b>	Refer to <a href="#">4.3.2 IDE Configuration</a> on page <a href="#">45</a>

Info / Item	Descriptions
Super IO Configuration	Refer to <a href="#">4.3.3 Super I/O Configuration</a> on page <a href="#">46</a>

**Caution:** Be careful when making system and hardware changes. Incorrect settings can cause system boot failure or malfunction.

### 4.3.1 CPU Configuration

Access this submenu to view the CPU information and its capabilities, including the CPU’s model name, processor speed, microcode revision, max./min. processor speeds, processor cores, and so on.

Aptio Setup Utility - Copyright (C) 2011 American Megatrends, Inc.

Main **Advanced** Chipset Boot Security Save & Exit

CPU Configuration		
Processor Type	Intel(R) Atom (TM) CPU	
EMT64	Supported	
Processor Speed	1865 MHz	
System Bus Speed	533 MHz	
Ratio Status	14	
Actual Ratio	14	
System Bus Speed	533 MHz	
Processor Stepping	30661	
Microcode Revision	262	
L1 Catch RAM	2x56 k	
L2 Catch RAM	2x512 k	
Processor Core	Dual	
Hyper-Threading	Supported	
Hyper-Threading	[Enabled]	
Execute Disable Bit	[Enabled]	
Limit CPUID Maximum	[Disabled]	
		→+: Select Screen ↓ ↑: Select Item Enter: Select +/-: Change Opt. F1: General Help F2: Previous Values F9: Optimized Defaults F10: Save & Exit ESC: Exit

Version 2.14.1219. Copyright (C) 2011 American Megatrends, Inc.

## 4.3.2 IDE Configuration

Access this submenu to view the harddisk information.

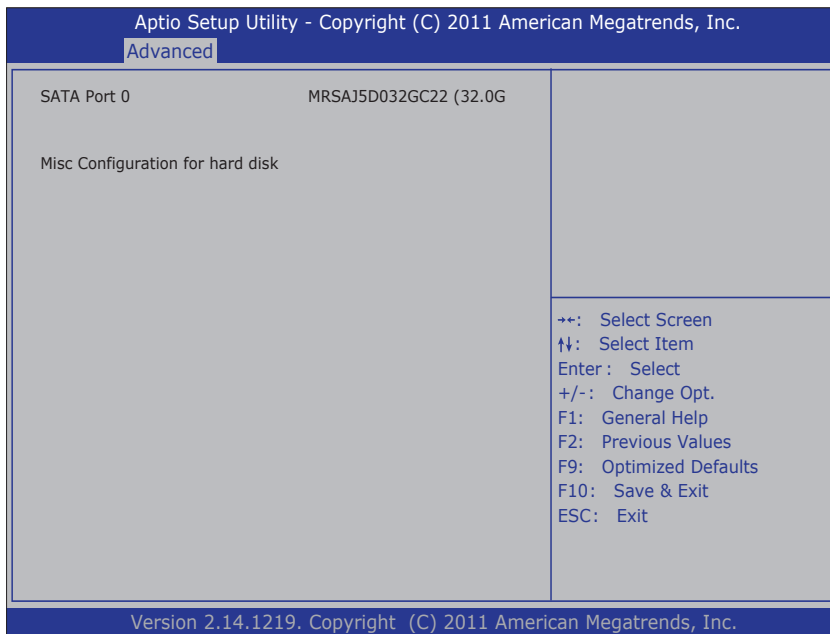

### 4.3.3 Super I/O Configuration

Access this submenu to configure the system's serial port.

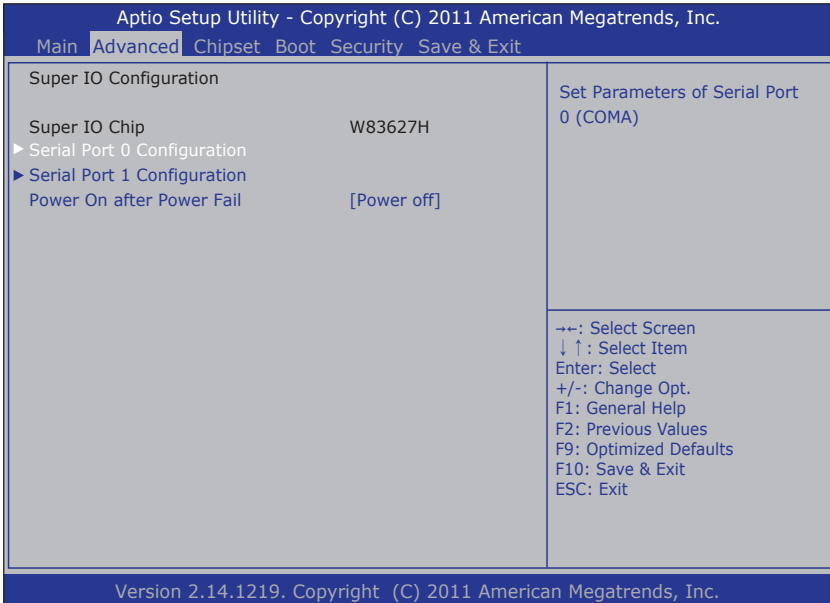

The **Super IO Configuration** screen provides the following setting options:

Settings	Descriptions
<b>Serial Port 0/1 Configuration</b>	<p>Configures the system's serial port (COM port). The settings include:</p> <p><b>Serial Port:</b> Enables/disables the serial port. Options: <b>Enabled</b> [default], <b>Disabled</b></p> <p><b>Device Settings:</b> Shows the I/O and IRQ address of the COM port.</p> <p><b>Change Settings:</b> Select an optimal setting for Super IO device.</p>
<b>Power On After Power Fail</b>	<p>Specify what state to go to when power is re-applied after a power failure.</p> <p>Options: <b>Power off</b> [default], <b>Power on</b></p>

## 4.4 Chipset

Access the **Chipset** menu and then select **Host Bridge** to view the system's memory information.

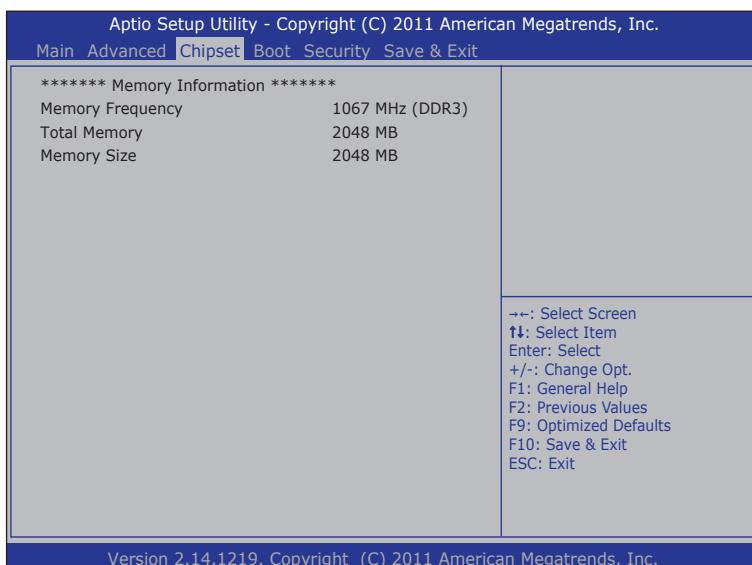
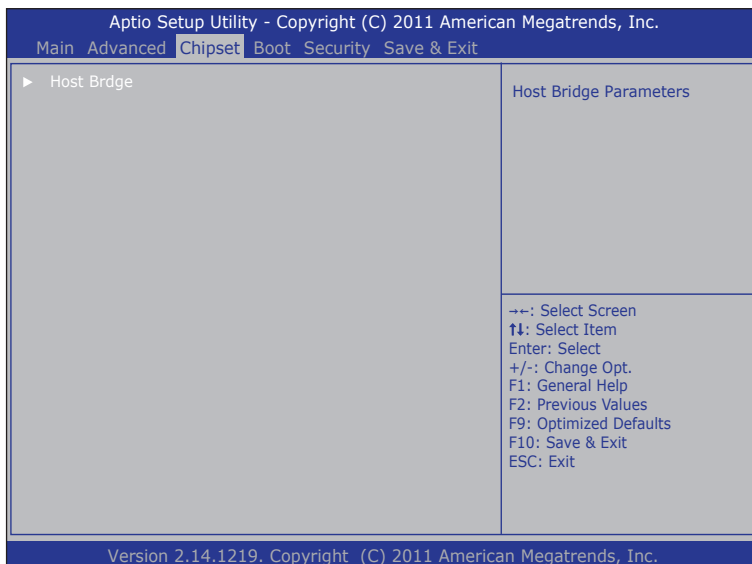

## 4.5 Boot

Access this menu to change system boot settings.

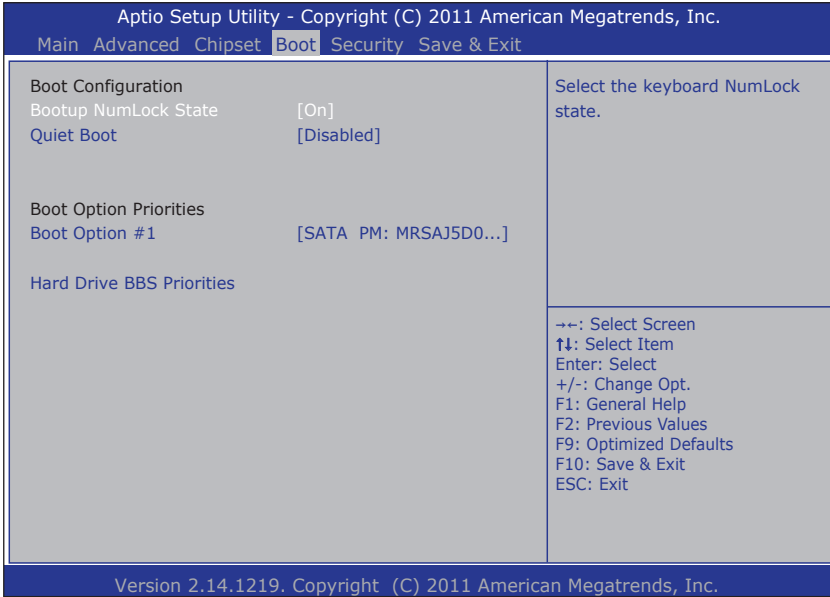

The **Boot** screen provides the following setting options:

Settings	Descriptions
<b>Bootup NumLock State</b>	Sets whether to enable or disable the keyboard’s NumLock state when the system starts up. Options: <b>On</b> [default], <b>Off</b> .
<b>Quiet Boot</b>	Sets whether to display the POST (Power-on Self Tests) messages or the system manufacturer’s full screen logo during booting. Leave it as <b>Disabled</b> , which is the default, to display the normal POST message.
<b>Boot Option Priorities</b>	Sets the system boot order
<b>Hard Drive BBS Priorities</b>	Sets the very 1st boot device among the available storage drives. BBS means “BIOS Boot Specification”.



## 4.6 Security

The **Security** menu sets up the administrator password. Once an administrator password is set up, this BIOS Setup utility is limited to access and will ask for the password each time any access is attempted.

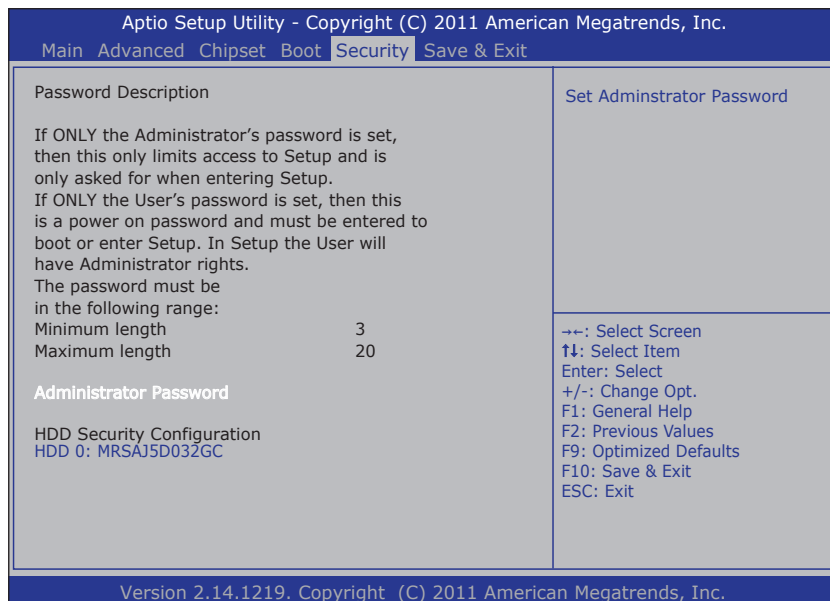

The **Security** screen provides the following setting options:

Settings	Descriptions
<b>Administrator Password</b>	<p>To set up an administrator password:</p> <ol style="list-style-type: none"> <li>1. Select <b>Administrator Password</b>.</li> <li>2. A <b>Create New Password</b> dialog then pops up onscreen.</li> <li>3. Enter your desired password that is no less than 3 characters and no more than 20 characters.</li> <li>4. Hit <b>[Enter]</b> key to submit.</li> </ol>
<b>HDD Security Configuration</b>	To view the HDD password configuration.

## 4.7 Save & Exit

The **Exit** menu features a handful of commands to launch actions from the BIOS Setup utility regarding saving changes, quitting the utility and recovering defaults.

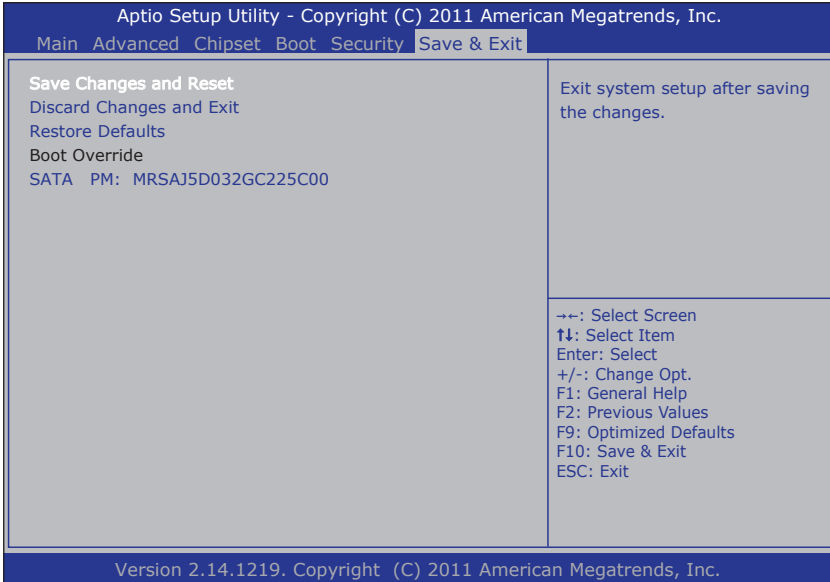

The **Save & Exit** screen provides the following setting options:

Settings	Descriptions
<b>Save Changes and Exit</b>	<p>Saves the changes and quits the BIOS Setup utility.</p> <ul style="list-style-type: none"> <li>▶ This is a command to launch an action from the BIOS Setup utility.</li> <li>▶ When prompted for confirmation, select <b>OK</b> to save the changes and quit the BIOS Setup, or select <b>Cancel</b> to return to BIOS Setup.</li> </ul>
<b>Discard Changes and Exit</b>	<p>Discards the changes and quits the BIOS Setup utility.</p> <p>This is a command to launch an action from the BIOS Setup utility.</p> <ul style="list-style-type: none"> <li>▶ When prompted for confirmation, select <b>OK</b> to quit BIOS Setup without saving the change(s), or select <b>Cancel</b> to return to the BIOS setup.</li> </ul>

---

Settings	Descriptions
<b>Restore Defaults</b>	<p>Loads the defaults to all settings.</p> <p>This is a command to launch an action from the BIOS Setup utility.</p> <p>When prompted for confirmation, select <b>OK</b> to load the defaults, or select <b>Cancel</b> to return to the BIOS setup.</p>
<b>Boot Override</b>	<p><b>Boot Override</b> presents a list in context with the boot devices installed in the system. Select the device to boot up the system regardless of the currently configured boot priority.</p> <p>This is a command to launch action from the BIOS Setup utility.</p>

---

This page is intentionally left blank.



# Appendix

## Optional Connections

## A. Installing the Handset Holder

If you are going to use the phone handset (optional), install the holder to the computer as described below.

1. Place the computer face-down on a soft flat surface.
2. Remove the two screws securing the bezel on the right side and remove the bezel.

Please keep the bezel and screws in a safe place for reuse in the future.



3. To use the buzzer function (optional), connect the 2-pin wire connector to the buzzer connector of the computer. If your vendor doesn't provide the related functionality, skip this step.



- Secure the holder to the computer with two screws included in the holder accessory pack.



## B. Using the Handset

The computer can be connected to a handset to facilitate voice communication through video conference, Skype, and instant messaging. However, the handset audio is disabled by default and you have to enable the phone function in BIOS.

**Note:** The audio of this medical computer switches between the phone and the speaker/headset of the medical computer. For instance, when you lift the phone, the audio is switched to the phone so that phone conversation can be carried out. When the phone is hung off, the audio is automatically switched to the system.





To use the phone handset:

- Install the handset holder to the computer as described in [A. Installing the Handset Holder](#) on page 54.
- Enter **BIOS > Advanced** and enable the **Phone Button Configuration** option.
- Using the RJ-11 phone cable included in the handset pack, connect one end to the handset and the other end to the **PHONE** jack on the rear of the computer.



4. Launch the voice communication software. When you lift the handset, the audio automatically switches to the phone so that conversation can be carried out.
5. Hang off the phone when the conversation finishes. When the phone is hung off, the audio automatically switches back to the system.

You can also use the phone key on the front panel to toggle the phone mode on and off. The Phone LED light also change accordingly to reflect current phone status as described in the following table.

If you want to...	Then...	Phone LED Status
Use the handset as the audio device	Lift the handset to go off-hook, or press the phone button  .	Light green
Switch the audio to the system.	Replace the handset in the holder to go on-hook, or press the phone button  . Then the audio will automatically switch to the system.	Off
Adjust the handset volume	Press the  or  button on the front panel to decrease or increase the volume	-



## C. Using the Remote Controller and Nurse Call Function

The computer can be optionally connected to a wired remote controller, enabling users to operate the medical computer or use navigation keys from a distance instead of touching the screens directly. The remote controller can also work as a handset for voice communication. Moreover, it comes with a nurse-call button on the rear to facilitate better communications between the patient, nurse and medical staff. This section will walk you through the function of the remote controller.

### C.1 Overview

#### C.1.1 Specifications



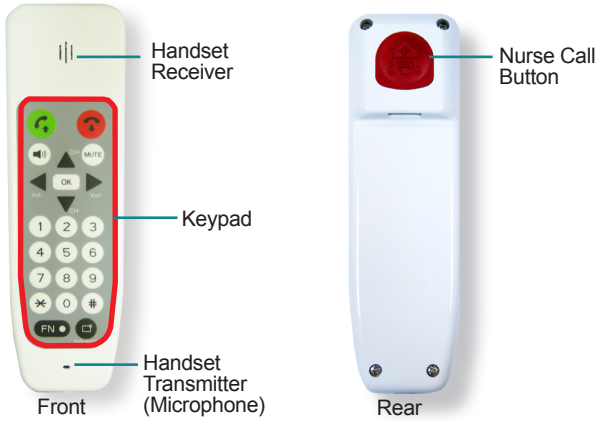

Item	Descriptions
<b>Dimensions (W x D x H)</b>	180 x 54 x 29mm (7.09" x 2.13" x 1.14")
<b>Weight</b>	108g
<b>Power Supply Voltage</b>	DC 5V provided by the computer
<b>Operating Temp.</b>	0 ~ 40°C (32 ~ 103°F)
<b>Storage Temp.</b>	-20 ~ 60°C (-4 ~ 140°F)
<b>Operating Humidity</b>	10~95% @ 40°C (non-condensing)
<b>Speaker</b>	1 x internal 0.5W speaker
<b>Microphone</b>	1 x digital microphone

### C.1.2 Parts of the Remote Controller

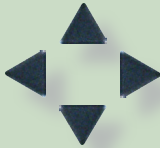

### C.1.3 Keypad

Keypad	Descriptions
	Places a phone call
	Ends a phone call
	Enables audio
	Mutes both system audio and handset audio
	Functions as the <b>Enter</b> key on a generic keyboard to perform the following: <ul style="list-style-type: none"> <li>To execute a command</li> <li>To confirm input</li> </ul>

Keypad	Descriptions															
	<p>Up/down/right/left navigation keys. The functions depend if FN (function) key is enabled.</p> <table border="1" data-bbox="359 272 1012 600"> <thead> <tr> <th data-bbox="359 272 452 311">Keys</th> <th data-bbox="452 272 729 311">FN key inactive</th> <th data-bbox="729 272 1012 311">FN Key Active</th> </tr> </thead> <tbody> <tr> <td data-bbox="359 311 452 384">▲</td> <td data-bbox="452 311 729 384">Acts as a general navigation key to perform the following:</td> <td data-bbox="729 311 1012 384">Goes up one channel</td> </tr> <tr> <td data-bbox="359 384 452 458">▼</td> <td data-bbox="452 384 729 458"> <ul style="list-style-type: none"> <li>Moves the caret in an input field.</li> </ul> </td> <td data-bbox="729 384 1012 458">Goes down one channel</td> </tr> <tr> <td data-bbox="359 458 452 531">◀</td> <td data-bbox="452 458 729 531"> <ul style="list-style-type: none"> <li>Navigates up/down/right/left among the highlight items in certain applications.</li> </ul> </td> <td data-bbox="729 458 1012 531">Decreases volume</td> </tr> <tr> <td data-bbox="359 531 452 600">▶</td> <td data-bbox="452 531 729 600"></td> <td data-bbox="729 531 1012 600">Increases volume</td> </tr> </tbody> </table>	Keys	FN key inactive	FN Key Active	▲	Acts as a general navigation key to perform the following:	Goes up one channel	▼	<ul style="list-style-type: none"> <li>Moves the caret in an input field.</li> </ul>	Goes down one channel	◀	<ul style="list-style-type: none"> <li>Navigates up/down/right/left among the highlight items in certain applications.</li> </ul>	Decreases volume	▶		Increases volume
Keys	FN key inactive	FN Key Active														
▲	Acts as a general navigation key to perform the following:	Goes up one channel														
▼	<ul style="list-style-type: none"> <li>Moves the caret in an input field.</li> </ul>	Goes down one channel														
◀	<ul style="list-style-type: none"> <li>Navigates up/down/right/left among the highlight items in certain applications.</li> </ul>	Decreases volume														
▶		Increases volume														
	<p>Numeric keypad for the following operation:</p> <ul style="list-style-type: none"> <li>Numeric characters input</li> <li>TV channel selection</li> <li>VoIP phone's dial pad</li> </ul>															
	<p>Turns on/off LCD</p>															
	<p>The <b>FN</b> (function) key, a modifier key to shift the function of some other keys.</p> <p>Press the <b>FN</b> key to activate the function key. When active, the LED lights white.</p> <p>Press the <b>FN</b> key again the disable the function key. When inactive, the LED is off.</p>															
	<p>Nurse-call button.</p> <p>To use this function, the remote controller must be connected to the nurse call system of the hospital.</p>															

## C.2 Connecting the Remote Controller

1. Connect the remote controller to the medical computer.
  - Using the provided DB9-to-RJ45 cable, connect the DB9 plug to the RC port of the medical computer and connect the RJ-45 plug to the RJ-45 coupler.
  - Connect the RJ-45 plug of the remote controller to the RJ-45 coupler.

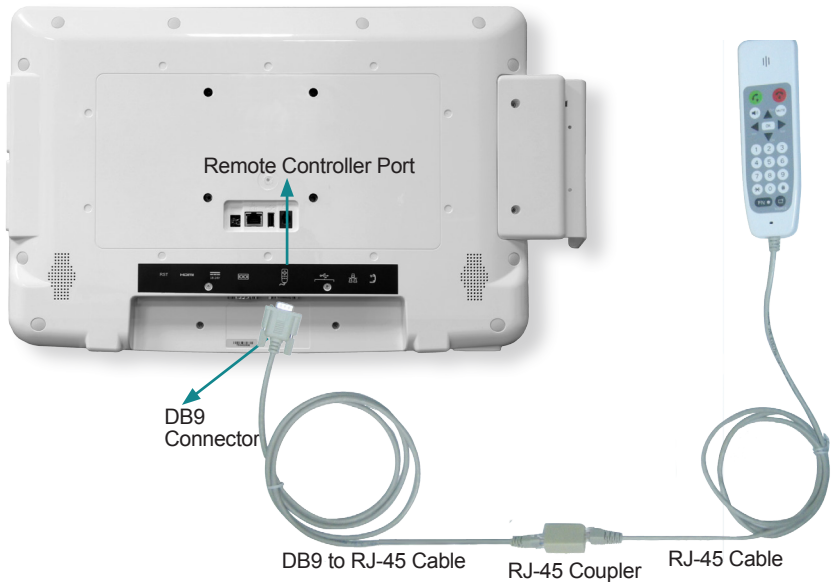

2. **To use the Nurse Call Function**, connect the computer's nurse call RJ-11 jack to the telephone jack of the hospital's nurse call system through a RJ-11 phone cable.

**Note:** If you are not going to use the nurse call button function on the remote controller, then you can skip this connection.

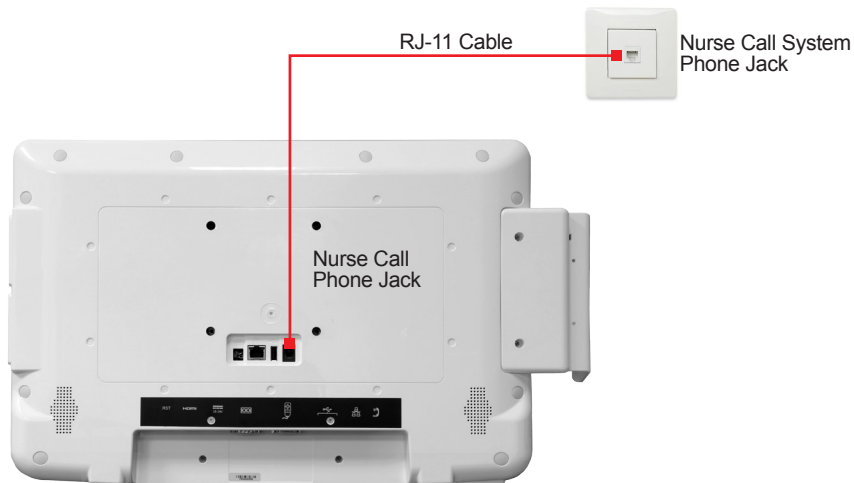

The Nurse Call function uses independent power supplied by the hospital's nurse call network. The pin assignment of the computer's Nurse Call jack is as below:

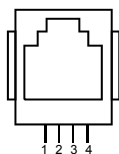

1. NC Pin
2. Nurse Call GND
3. Nurse Call COMM
4. Nurse Call Power

## C.3 Programing Your Own Remote Controller Applications

For software developers to develop their own remote controller applications, please refer to the key mapping table and sample codes as a design reference.

### D.3.1 Key Mapping Table

Remote Controller Key	Key Code	Scan Code
Phone On	F24	118
Phone Off	F23	110
Audio Switch	F22	109
Mute	Mute	N/A
Num 1	Keypad 1	79
Num 2	Keypad 2	80
Num 3	Keypad 3	81
Num 4	Keypad 4	75
Num 5	Keypad 5	76
Num 6	Keypad 6	77
Num 7	Keypad 7	71
Num 8	Keypad 8	72
Num 9	Keypad 9	73
Num 0	Keypad 0	82
*	Keypad *	55
#	F16	103
OK	Enter	28
LCD On/Off	F21	108
Source	F20	107
Up	Up	72
Down	Down	80
Left	Left	75
Right	Right	77
CH +	F19	106
CH -	F18	105

Remote Controller Key	Key Code	Scan Code
Vol +	Vol +	N/A
Vol -	Vol -	N/A
Nurse Call	F17	104

### D.3.2 Linux Sample Code

**Note:** NumLock isn't enabled upon Linux boot-up. You must make sure NumLock is active for keypad numbers. Use "apt-get install numlockx" or "yum install numlockx" to enable NumLock during application starting. See the sample code hereunder.

```
#include <sys/io.h>
#include <stdio.h>
#include <linux/input.h>

#define ARBOR_M1858_ECRAM_ADDR 0x0500
#define ARBOR_M1858_ECRAM_ADDR2 0x160A
#define ARBOR_M1858_ECRAM_ADDR3 0x0202
#define ARBOR_M1858_ECRAM_ADDR4 0x0461

//-----
//----- ARBOR GPIO -----
//-----

unsigned long Process_686C_Command_Write(unsigned long m_ECCMD, unsigned long m_ECDATA)
{
//-----
-----
int i,temp;
unsigned long m_OutBuf;
//-----
-----
m_OutBuf=inb_p(0x6C);
if ( ( m_OutBuf&0x00000003) > 0 )
{
temp=inb_p(0x68);
return 0xFFFFFFFF;
}

outb_p(m_ECCMD, 0x6C);
for ( i=0; i<=4000; i++ )
```

## Appendix

---

```
{
    m_OutBuf=inb_p(0x6C);
    if ( ( m_OutBuf&0x00000002) == 0 ) break;
}
if ( i < 3999 )
{
    outb_p(m_ECADATA, 0x68);
    for ( i=0; i<=4000; i++ )
    {
        m_OutBuf=inb_p(0x6C);
        if ( ( m_OutBuf&0x00000002) == 0 )
            { return 0x00000000; }
    }
}

if ( i > 3999 ) m_OutBuf=inb_p(0x68);
return 0xFFFFFFFF;
}
//-----
-----
unsigned long Process_686C_Command_Read(unsigned long m_ECCMD )
{
int i,temp;
unsigned long m_OutBuf,m_InBuf;
m_OutBuf=inb_p(0x6C);
if ( ( m_OutBuf&0x00000003) > 0 )
{
    temp=inb_p(0x68);
    return 0xFFFFFFFF;

}
m_InBuf = m_ECCMD;
outb_p(m_InBuf, 0x6C);
for ( i=0; i<=3500; i++ )
{
    m_OutBuf=inb_p(0x6C);
    if ( ( m_OutBuf&0x00000001) > 0 )
    {
        temp=inb_p(0x68);
        temp= (temp & 0x000000FF) ;
        return temp;
        break;
    }
}
}
if ( i > 3499 )
{
    temp=inb_p(0x68);
    return 0xFFFFFFFF;
}
}
```



```
//-----  
-----  
unsigned long ECU_Read_686C_RAM_BYTE( unsigned long ECUMemAddr )  
{  
    unsigned long uDATA1,uDATA2,ECRamAddrH,ECRamAddrL;  
    ECRamAddrL=ECUMemAddr%256;    ECRamAddrH=ECUMemAddr/256;  
    //  
    uDATA1=Process_686C_Command_Write(0x000000A3, ECRamAddrH );  
  
    if ( uDATA1==0xFFFFFFFF ) { return 0xFFFFFFFF; }  
    //  
    uDATA1=Process_686C_Command_Write(0x000000A2, ECRamAddrL );  
  
    if ( uDATA1==0xFFFFFFFF ) { return 0xFFFFFFFF; }  
    //  
    uDATA1=Process_686C_Command_Read( 0x000000A4 );  
  
    if ( uDATA1 > 0x000000FF ) { return 0xFFFFFFFF; }  
    uDATA2=Process_686C_Command_Read( 0x000000A4 );  
  
    if ( uDATA2 > 0x000000FF ) { return 0xFFFFFFFF; }  
  
    if (uDATA1==uDATA2) return uDATA1;  
    else return 0xFFFFFFFF;  
}  
//-----  
-----  
unsigned long ECU_Write_686C_RAM_BYTE( unsigned long  
ECUMemAddr,unsigned long ECUMemData )  
{  
    unsigned long uDATA, RD_DATA, ECRamAddrH, ECRamAddrL;  
    ECRamAddrL=ECUMemAddr%256;    ECRamAddrH=ECUMemAddr/256;  
    //  
    uDATA=Process_686C_Command_Write(0x000000A3, ECRamAddrH );  
    if ( uDATA==0xFFFFFFFF ) { return 0xFFFFFFFF; }  
    //  
    uDATA=Process_686C_Command_Write(0x000000A2, ECRamAddrL );  
    if ( uDATA==0xFFFFFFFF ) { return 0xFFFFFFFF; }  
    //  
    uDATA=Process_686C_Command_Write(0x000000A5, ECUMemData );  
    if ( uDATA==0xFFFFFFFF ) { return 0xFFFFFFFF; }  
    //  
    return 0x00000000;  
}  
  
main()  
{  
    unsigned long ldata;  
    unsigned long temp;
```

```
int res=0;
FILE * keyfd = NULL;
struct input_event ie;
int LCDStatus = 1;

system("/usr/bin/numlockx on"); //enable NumLock

res=iopl(3);
setuid(500);

keyfd = fopen("/dev/input/event16", "r"); //application must
choose correct event for remote control

if(keyfd != NULL)
{

    while(1)
    {
        fread((void *)&ie, sizeof(ie), 1, keyfd);
        if (ferror(keyfd))
        {
            perror("fread");
            exit(1);
        }

        if(ie.code == 1 && ie.value == 1) //ESC
        {
            //exit application
            printf("Exit\n");
            break;
        }

        if(ie.code == 194 && ie.value == 1) //F24
        {
            printf("Phone On\n");
        }
        if(ie.code == 193 && ie.value == 1) //F23
        {
            printf("Phone Off\n");
        }
        if(ie.code == 192 && ie.value == 1) //F22
        {
            printf("Audio switch\n");
        }
        if(ie.code == 191 && ie.value == 1) //F21
        {
            printf("LCD On/off\n");
            if( LCDStatus == 1)
```

```

{
    if(temp == 0xFFFFFFFF)
        temp = ECU_Read_686C_RAM_
BYTE(0x1604);

    if(temp != 0xFFFFFFFF)
    {
        //backlight off
        temp &= 0xBF;
        ECU_Write_686C_RAM_
BYTE(0x1604,temp);
    }

    temp = ECU_Read_686C_RAM_
BYTE(0x1605);

    if(temp == 0xFFFFFFFF)
        temp = ECU_Read_686C_RAM_
BYTE(0x1605);

    if(temp != 0xFFFFFFFF)
    {
        // TOUCH_SHDN Switch off
        temp &= 0xDF;
        ECU_Write_686C_RAM_
BYTE(0x1605,temp);

        LCDStatus = 0;
    }
}
else if(LCDStatus == 0)
{
    temp = ECU_Read_686C_RAM_BYTE(0x1604);
    if(temp == 0xFFFFFFFF)
        temp = ECU_Read_686C_RAM_
BYTE(0x1604);

    if(temp != 0xFFFFFFFF)
    {
        //backlight on
        temp |= 0x40;
        ECU_Write_686C_RAM_
BYTE(0x1604,temp);

        LCDStatus = 1;
    }

    temp = ECU_Read_686C_RAM_
BYTE(0x1605);

    if(temp == 0xFFFFFFFF)
        temp = ECU_Read_686C_RAM_
BYTE(0x1605);

    if(temp != 0xFFFFFFFF)
    {
        // TOUCH_SHDN Switch off
        temp &= 0xDF;

```

```

                                                    ECU_Write_686C_RAM_
BYTE(0x1605,temp);
    }
}

if(ie.code == 190 && ie.value == 1) //F20
{
    printf("Video Switch\n");
}
if(ie.code == 189 && ie.value == 1) //F19
{
    printf("CH +\n");
}
if(ie.code == 188 && ie.value == 1) //F18
{
    printf("CH -\n");
}
if(ie.code == 187 && ie.value == 1) //F17
{
    printf("Nurse Call\n");
}
if(ie.code == 186 && ie.value == 1) //F16
{
    printf("#\n");
}
}
}

if(keyfd != NULL)
    fclose(keyfd);
}

```