



NEXCOM International Co., Ltd.

Intelligent Digital Security

Video Intelligent Surveillance

NViS 1482 Series

User Manual

CONTENTS

Preface

Copyright	iv
Disclaimer	iv
Acknowledgements	iv
Regulatory Compliance Statements.....	iv
Declaration of Conformity.....	iv
RoHS Compliance	v
Warranty and RMA	vi
Safety Information	viii
Installation Recommendations.....	viii
Safety Precautions.....	ix
Technical Support and Assistance.....	x
Conventions Used in this Manual.....	x
Global Service Contact Information.....	xi
Package Contents.....	xiii
Ordering Information.....	xiv

Chapter 1: Product Introduction

Overview	1
Key Features.....	1
Hardware Specifications.....	2
Knowing Your NViS 1482 Series.....	3
Front Panel.....	3
NViS 1482 Rear Panel.....	4
Mechanical Dimensions.....	5
Mechanical Dimensions.....	6

Mechanical Dimensions.....	7
----------------------------	---

Chapter 2: Jumpers and Connectors

Before You Begin	8
Precautions	8
Jumper Settings.....	9
Locations of the Jumpers and Connectors.....	10
Jumpers.....	11
Clear CMOS.....	11
Connector Pin Definitions	12
54V Power-in Connector (Outside).....	12
PoE LAN 8 Ports RJ45 Connector	12
GPIO Connector.....	13
System Fan	14
USB2.0 Connector.....	14
HDD/PWR LED Wire.....	15
SATA Connector.....	15
SATA Connector.....	16
SATA Power Connector	16
Audio Connectors	17
Power SW Connector	17
COM Port Connector.....	18
Debug Port Connector.....	18
LAN1 Connector and USB 3.0 Ports.....	19
LAN2 Connector and USB 3.0 Ports.....	19
SPI BIOS Update Connector	20

- HDMI Connector 20
- DVI-I and RS485 Connector 21
- POE 8 Ports LAN LED Connector 22
- M.2 B Key Connector 23
- PoE Switch Action Guidance 24
 - PoE Switch Connector Define (Rear IO) 24
 - PoE Switch LED Indicator Status (Front Side) 24
 - PoE Switch Deployment 24
- Block Diagram 26

- Save & Exit 63

Chapter 3: System Setup

- Removing the Chassis Cover 27
- Installing the 3.5" HDD 28
- Installing the 2.5" SSD/HDD 34
- Tightening Cable Guidance For 2.5" SSD/HDD 37
- Installing M.2 SSD 39
- Installing Memory SO-DIMM (Use DDR4 SO-DIMM) 41

Chapter 4: BIOS Setup

- About BIOS Setup 43
- When to Configure the BIOS 43
- Default Configuration 44
- Entering Setup 44
- Legends 44
- BIOS Setup Utility 46
 - Main 46
 - Advanced 47
 - Chipset 56
 - Security 61
 - Secure Boot 62
 - Boot 62

PREFACE

Copyright

This publication, including all photographs, illustrations and software, is protected under international copyright laws, with all rights reserved. No part of this manual may be reproduced, copied, translated or transmitted in any form or by any means without the prior written consent from NEXCOM International Co., Ltd.

Disclaimer

The information in this document is subject to change without prior notice and does not represent commitment from NEXCOM International Co., Ltd. However, users may update their knowledge of any product in use by constantly checking its manual posted on our website: <http://www.nexcom.com>. NEXCOM shall not be liable for direct, indirect, special, incidental, or consequential damages arising out of the use of any product, nor for any infringements upon the rights of third parties, which may result from such use. Any implied warranties of merchantability or fitness for any particular purpose is also disclaimed.

Acknowledgements

NViS 1482 is a trademarks of NEXCOM International Co., Ltd. All other product names mentioned herein are registered trademarks of their respective owners.

Regulatory Compliance Statements

This section provides the FCC compliance statement for Class B devices and describes how to keep the system CE compliant.

Declaration of Conformity

FCC

This equipment has been tested and verified to comply with the limits for a Class B digital device, pursuant to Part 15 of FCC Rules. These limits are designed to provide reasonable protection against harmful interference when the equipment is operated in a commercial environment. This equipment generates, uses, and can radiate radio frequency energy and, if not installed and used in accordance with the instructions, may cause harmful interference to radio communications. Operation of this equipment in a residential area (domestic environment) is likely to cause harmful interference, in which case the user will be required to correct the interference (take adequate measures) at their own expense.

CE

The product(s) described in this manual complies with all applicable European Union (CE) directives if it has a CE marking. For computer systems to remain CE compliant, only CE-compliant parts may be used. Maintaining CE compliance also requires proper cable and cabling techniques.

RoHS Compliance



NEXCOM RoHS Environmental Policy and Status Update

NEXCOM is a global citizen for building the digital infrastructure. We are committed to providing green products and services, which are compliant with European Union RoHS (Restriction on Use of Hazardous Substance in Electronic Equipment) directive 2011/65/EU, to be your trusted green partner and to protect our environment.

RoHS restricts the use of Lead (Pb) < 0.1% or 1,000ppm, Mercury (Hg) < 0.1% or 1,000ppm, Cadmium (Cd) < 0.01% or 100ppm, Hexavalent Chromium (Cr6+) < 0.1% or 1,000ppm, Polybrominated biphenyls (PBB) < 0.1% or 1,000ppm, and Polybrominated diphenyl Ethers (PBDE) < 0.1% or 1,000ppm.

In order to meet the RoHS compliant directives, NEXCOM has established an engineering and manufacturing task force to implement the introduction of green products. The task force will ensure that we follow the standard NEXCOM development procedure and that all the new RoHS components and new manufacturing processes maintain the highest industry quality levels for which NEXCOM are renowned.

The model selection criteria will be based on market demand. Vendors and suppliers will ensure that all designed components will be RoHS compliant.

How to recognize NEXCOM RoHS Products?

For existing products where there are non-RoHS and RoHS versions, the suffix "(LF)" will be added to the compliant product name.

All new product models launched after January 2013 will be RoHS compliant. They will use the usual NEXCOM naming convention.

Warranty and RMA

NEXCOM Warranty Period

NEXCOM manufactures products that are new or equivalent to new in accordance with industry standard. NEXCOM warrants that products will be free from defect in material and workmanship for 2 years, beginning on the date of invoice by NEXCOM. HCP series products (Blade Server) which are manufactured by NEXCOM are covered by a three year warranty period.

NEXCOM Return Merchandise Authorization (RMA)

- Customers shall enclose the “NEXCOM RMA Service Form” with the returned packages.
- Customers must collect all the information about the problems encountered and note anything abnormal or, print out any on-screen messages, and describe the problems on the “NEXCOM RMA Service Form” for the RMA number apply process.
- Customers can send back the faulty products with or without accessories (manuals, cable, etc.) and any components from the card, such as CPU and RAM. If the components were suspected as part of the problems, please note clearly which components are included. Otherwise, NEXCOM is not responsible for the devices/parts.
- Customers are responsible for the safe packaging of defective products, making sure it is durable enough to be resistant against further damage and deterioration during transportation. In case of damages occurred during transportation, the repair is treated as “Out of Warranty.”
- Any products returned by NEXCOM to other locations besides the customers’ site will bear an extra charge and will be billed to the customer.

Repair Service Charges for Out-of-Warranty Products

NEXCOM will charge for out-of-warranty products in two categories, one is basic diagnostic fee and another is component (product) fee.

Repair Service Charges for Out-of-Warranty Products

NEXCOM will charge for out-of-warranty products in two categories, one is basic diagnostic fee and another is component (product) fee.

System Level

- Component fee: NEXCOM will only charge for main components such as SMD chip, BGA chip, etc. Passive components will be repaired for free, ex: resistor, capacitor.
- Items will be replaced with NEXCOM products if the original one cannot be repaired. Ex: motherboard, power supply, etc.
- Replace with 3rd party products if needed.
- If RMA goods can not be repaired, NEXCOM will return it to the customer without any charge.

Board Level

- Component fee: NEXCOM will only charge for main components, such as SMD chip, BGA chip, etc. Passive components will be repaired for free, ex: resistors, capacitors.
- If RMA goods can not be repaired, NEXCOM will return it to the customer without any charge.

Warnings

Read and adhere to all warnings, cautions, and notices in this guide and the documentation supplied with the chassis, power supply, and accessory modules. If the instructions for the chassis and power supply are inconsistent with these instructions or the instructions for accessory modules, contact the supplier to find out how you can ensure that your computer meets safety and regulatory requirements.

Cautions

Electrostatic discharge (ESD) can damage system components. Do the described procedures only at an ESD workstation. If no such station is available, you can provide some ESD protection by wearing an antistatic wrist strap and attaching it to a metal part of the computer chassis.

Safety Information

Before installing and using the device, note the following precautions:

- Read all instructions carefully.
- Do not place the unit on an unstable surface, cart, or stand.
- Follow all warnings and cautions in this manual.
- When replacing parts, ensure that your service technician uses parts specified by the manufacturer.
- Avoid using the system near water, in direct sunlight, or near a heating device.
- The load of the system unit does not solely rely for support from the rackmounts located on the sides. Firm support from the bottom is highly necessary in order to provide balance stability.
- The computer is provided with a battery-powered real-time clock circuit. There is a danger of explosion if battery is incorrectly replaced. Replace only with the same or equivalent type recommended by the manufacturer. Discard used batteries according to the manufacturer's instructions.

Installation Recommendations

Ensure you have a stable, clean working environment. Dust and dirt can get into components and cause a malfunction. Use containers to keep small components separated.

Adequate lighting and proper tools can prevent you from accidentally damaging the internal components. Most of the procedures that follow require only a few simple tools, including the following:

- A Philips screwdriver
- A flat-tipped screwdriver
- A grounding strap
- An anti-static pad

Using your fingers can disconnect most of the connections. It is recommended that you do not use needle-nose pliers to disconnect connections as these can damage the soft metal or plastic parts of the connectors.

Safety Precautions

1. Read these safety instructions carefully.
2. Keep this User Manual for later reference.
3. Disconnect this equipment from any AC outlet before cleaning. Use a damp cloth. Do not use liquid or spray detergents for cleaning.
4. For plug-in equipment, the power outlet socket must be located near the equipment and must be easily accessible.
5. Keep this equipment away from humidity.
6. Put this equipment on a stable surface during installation. Dropping it or letting it fall may cause damage.
7. The openings on the enclosure are for air convection to protect the equipment from overheating. **DO NOT COVER THE OPENINGS.**
8. Make sure the voltage of the power source is correct before connecting the equipment to the power outlet.
9. Place the power cord in a way so that people will not step on it. Do not place anything on top of the power cord. Use a power cord that has been approved for use with the product and that it matches the voltage and current marked on the product's electrical range label. The voltage and current rating of the cord must be greater than the voltage and current rating marked on the product.
10. All cautions and warnings on the equipment should be noted.
11. If the equipment is not used for a long time, disconnect it from the power source to avoid damage by transient overvoltage.
12. Never pour any liquid into an opening. This may cause fire or electrical shock.
13. Never open the equipment. For safety reasons, the equipment should be opened only by qualified service personnel.
14. If one of the following situations arises, get the equipment checked by service personnel:
 - a. The power cord or plug is damaged.
 - b. Liquid has penetrated into the equipment.
 - c. The equipment has been exposed to moisture.
 - d. The equipment does not work well, or you cannot get it to work according to the user's manual.
 - e. The equipment has been dropped and damaged.
 - f. The equipment has obvious signs of breakage.
15. Do not place heavy objects on the equipment.
16. The unit uses a three-wire ground cable which is equipped with a third pin to ground the unit and prevent electric shock. Do not defeat the purpose of this pin. If your outlet does not support this kind of plug, contact your electrician to replace your obsolete outlet.
17. **CAUTION: DANGER OF EXPLOSION IF BATTERY IS INCORRECTLY REPLACED. REPLACE ONLY WITH THE SAME OR EQUIVALENT TYPE RECOMMENDED BY THE MANUFACTURER. DISCARD USED BATTERIES ACCORDING TO THE MANUFACTURER'S INSTRUCTIONS.**

Technical Support and Assistance

1. For the most updated information of NEXCOM products, visit NEXCOM's website at www.nexcom.com.
2. For technical issues that require contacting our technical support team or sales representative, please have the following information ready before calling:
 - Product name and serial number
 - Detailed information of the peripheral devices
 - Detailed information of the installed software (operating system, version, application software, etc.)
 - A complete description of the problem
 - The exact wordings of the error messages

Warning!

1. Handling the unit: carry the unit with both hands and handle it with care.
2. Maintenance: to keep the unit clean, use only approved cleaning products or clean with a dry cloth.
3. CompactFlash: Turn off the unit's power before inserting or removing a CompactFlash storage card.

Conventions Used in this Manual



Warning:

Information about certain situations, which if not observed, can cause personal injury. This will prevent injury to yourself when performing a task.



Caution:

Information to avoid damaging components or losing data.



Note:

Provides additional information to complete a task easily.

Global Service Contact Information

Headquarters

NEXCOM International Co., Ltd.

9F, No. 920, Chung-Cheng Rd.,
ZhongHe District, New Taipei City, 23586,
Taiwan, R.O.C.

Tel: +886-2-8226-7786

Fax: +886-2-8226-7782

www.nexcom.com

Asia

Taiwan

NexAIoT Co., Ltd.

Taipei Office

13F, No.916, Chung-Cheng Rd.,
ZhongHe District,
New Taipei City, 23586, Taiwan, R.O.C.

Tel: +886-2-8226-7796

Fax: +886-2-8226-7926

Email: sales@nexaiot.com.tw

www.nexaiot.com.tw

NexAIoT Co., Ltd.

Taichung Office

16F, No.250, Sec. 2, Chongde Rd.,
Beitun Dist.,

Taichung City 406, R.O.C.

Tel: +886-4-2249-1179

Fax: +886-4-2249-1172

Email: sales@nexaiot.com.tw

www.nexaiot.com.tw

NexCOBOT Taiwan Co., Ltd.

13F, No.916, Chung-Cheng Rd.,
ZhongHe District,
New Taipei City, 23586, Taiwan, R.O.C.

Tel: +886-2-8226-7786

Fax: +886-2-8226-7926

Email: sales@nexcobot.com.tw

www.nexcobot.com.tw

GreenBase Technology Corp.

13F, No.922, Chung-Cheng Rd.,
Zhonghe Dist.,
New Taipei City, 23586, Taiwan, R.O.C.

Tel: +886-2-8226-7786

Fax: +886-2-8226-7900

Email: sales@nexcom.com.tw

www.nexcom.com.tw

China

NEXSEC Incorporated

5F, No.4, No.7 Fengxian Middle Rd.,
(Beike Industrial Park), Haidian District,
Beijing, 100094, China

Tel: +86-10-5704-2680

Fax: +86-10-5704-2681

Email: sales@nexsec.cn

www.nexsec.cn

NEXCOM Shanghai

No.4, 16 Building,
Shanghai OMNI Tech & Science Park
No. 1699, Douhui Rd.,
Shanghai, 201108, China
Tel: +86-21-5278-5868
Fax: +86-21-3251-6358
Email: sales@nexcom.cn
www.nexcom.cn

NEXCOM Surveillance Technology Corp.

5F, Building C, ZhenHan Industrial Zone,
GanKeng Community, Buji Street,
LongGang District,
ShenZhen, 518112, China
Tel: +86-755-8364-7768
Fax: +86-755-8364-7738
Email: steveyang@nexcom.com.tw
www.nexcom.cn

NEXCOM United System Service

Room 603/604, Huiyinmingzun Plaza Bldg. 1,
No. 609, Yunlin East Rd.,
Shanghai, 200062, China
Tel: +86-21-5278-5868
Fax: +86-21-3251-6358
Email: renwang@nexcom.com.tw
www.nexcom.cn

NEXGOL

1F, Building B4, Electronic 2nd Area,
(Phoenix Lake Industrial Park), Yongchuan Dist.,
Chongqing City, 402160, China
Tel: +86-23-4960-9080
Fax: +86-23-4966-5855
Email: sales@nexcobot.com
www.nexgol.com/NexGoL

Beijing NexGemo Technology Co.,Ltd.

5F, Gemotech Building, No.1, Development Rd.,
Changping International Information Industry Base,
Changping District,
Beijing, 102206, China
Tel: +86-10-8190-9328
Fax: +86-10-8190-9456

Japan**NEXCOM Japan**

9F, Tamachi Hara Bldg.,
4-11-5, Shiba Minato-ku,
Tokyo, 108-0014, Japan
Tel: +81-3-5419-7830
Fax: +81-3-5419-7832
Email: sales@nexcom-jp.com
www.nexcom-jp.com

Europe**United Kingdom
NEXCOM EUROPE**

10 Vincent Avenue,
Crownhill Business Centre,
Milton Keynes, Buckinghamshire
MK8 0AB, United Kingdom
Tel: +44-1908-267121
Fax: +44-1908-262042
Email: sales.uk@nexcom.eu
www.nexcom.eu

**America
USA****NEXCOM USA**

46665 Fremont Blvd.,
Fremont CA 94538, USA
Tel: +1-510-656-2248
Fax: +1-510-656-2158
Email: sales@nexcom.com
www.nexcomusa.com

Package Contents

Before continuing, verify that the NViS 1482 series package that you received is complete. Your package should have all the items listed in the following table.

NViS 1482

Item	Part Number	Name	Description	Qty
	10C00148200X0	NViS 1482 System	NViS 1482 CPU J6412	1
1	50311F0310X00	P Head Screw	P6#32x6 NI+Nylok+Nyseal for 3.5" HDD bracket	4
2	50311F0660X00	I Head Screw	I3x6 NI+Nylok for 2.5" HDD bracket	4
3	6016600007X00	Cable Tie	L=160mm W=2.5mm 21SPC(a)(h)(f2)-UL	1
4	603ATA0159X00	SATA Cable	SATA 7P/F/LATCH 180D TO 7P/F/LATCH 180D BLUE L=150mm	2
5	603POW0467X00	SATA Power Cable	SATA 15P/F/Latch TO 1x4P H.S PH:2.5mm L=150mm	2
6	7400180011X00	Power Adapter	Power Adapter EDAC:EA11701S 180W 54V/3.33A 4Pin Power Molding	1

Ordering Information

The following information below provides ordering information for the NViS 1482 series.

NViS 1482 (P/N: 10C00148200X0)

NViS1482 desktop SoC NVR with Intel® Elkhart Lake platform built-in 8-port PoE

CHAPTER 1: PRODUCT INTRODUCTION

Overview



Key Features

- Intel Celeron J6412, Quad Core 2.0GHz
- Max. 32GB DDR4 supported
- Dual display of HDMI and DVI-I
- 1 x 3.5" SATA HDD
- 1 x 2.5" SATA HDD or SSD/1 x M.2 2242 Key B SATA III (select either one)
- 1 x 10/100/1000 Intel® Ethernet
- 1 x 2.5G Intel Ethernet
- 8 x 10/100 PoE (120W max PSE)
- Support TPM 2.0 onboard
- Support eMMC onboard (option)

Hardware Specifications

CPU Support

- Intel 8th Gen Intel® Celeron® J6412, Quad Core, 2.0GHz base frequency, 2.6 GHz burst frequency (compatible with other Intel 8th Gen Intel Atom® (Elkhart Lake) processor X Series and Intel® Celeron® J Series)

Main Memory

- Dual channel DDR4 3200 MHz SDRAM, max. 32GB

I/O Interface-Front

- 2 x USB 2.0 ports
- Power & HDD status LED
- PoE 8 ports status LED

I/O Interface-Rear

- 2 x RJ45 (1 x 1GbE + 1 x 2.5GbE)
- 4 x USB 3.1 Gen1 ports
- 1 x HDMI 2.0b (supports max. resolution 4096 x 2160 @ 60Hz)
- 1 x DVI-I
- 1 x UART port (RS-232/485 setting from BIOS)
- 1 x Min-in & 1 x Line-Out & 1 x MIC
- Power on/off switch
- 54V DC-IN jack (4-pin)
- 8 x Ethernet PoE port
 - 802.3af/at compliance with total 120W max (PSE)
 - 802.3af support 8 ports @ 15W
 - 802.3at support 4 ports @30W
- 1 x 4DI/2DO (relay type) terminal block or 4DI/4DO GPIO DB15 port (option)

Storage

- 1 x 3.5" SATA HDD
- 1 x 2.5" SATA HDD or SSD/1 x M.2 2242 Key B SATAIII (select either one)
- 1 x eMMC 32GB (option)

Power Input

- Adapter 54V/3.34A 180W

Dimensions

- 360mm (W) x 49mm (H) x 224.5mm (D)

Environment

- Operating Temperature:
Ambient with air flow: 0°C to 40°C
- Storage temperature: -20°C to 70°C
- Relative humidity: 10% to 90% (non-condensing)

Certifications

- CE approval
- FCC Class A
- UL 62368 compliance

Knowing Your NViS 1482 Series Front Panel

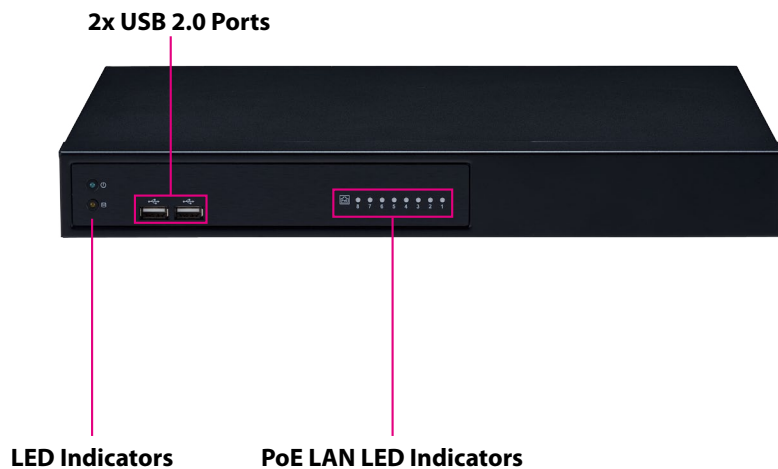

LED Indicators

Indicates the power status of the system.
Indicates the status of the hard drive.

Dual USB Ports

Used to connect USB 2.0 devices.

PoE LAN LED Indicators

Indicates the status of the LAN ports.

NViS 1482 Rear Panel

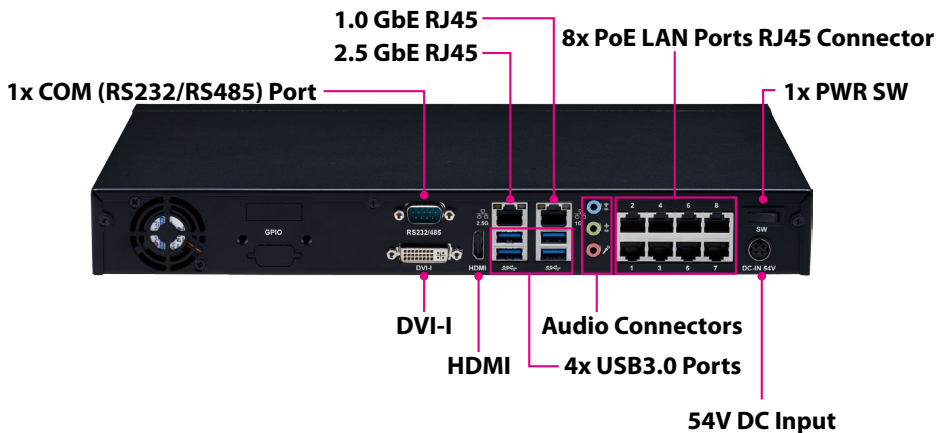

1x COM (RS232/RS485) Port (BIOS Support)

Supports RS232 and RS485 compatible serial devices.

DVI-I

Used to connect a digital LCD panel.

HDMI

Used to connect a high-definition display.

1.0 GbE RJ45/2.5 GbE RJ45

Used to connect the system to a local area network.

4x USB3.0 Ports

Four USB ports to connect the system with USB 3.0 devices.

Audio Connectors (Line in/Line out/MIC in)

Line in: Receives audio signal input

Line out: Provides audio signal output

MIC-in: Used to connect an external microphone

8x PoE LAN Ports RJ45 Connectors

Enables communication among network clients and delivers power using the same RJ45 to PoE-enabled edge devices.

Power Switch

Press to power on the device.

54V DC Input

Used to plug a DC power cord.

Mechanical Dimensions

Rackmount Model

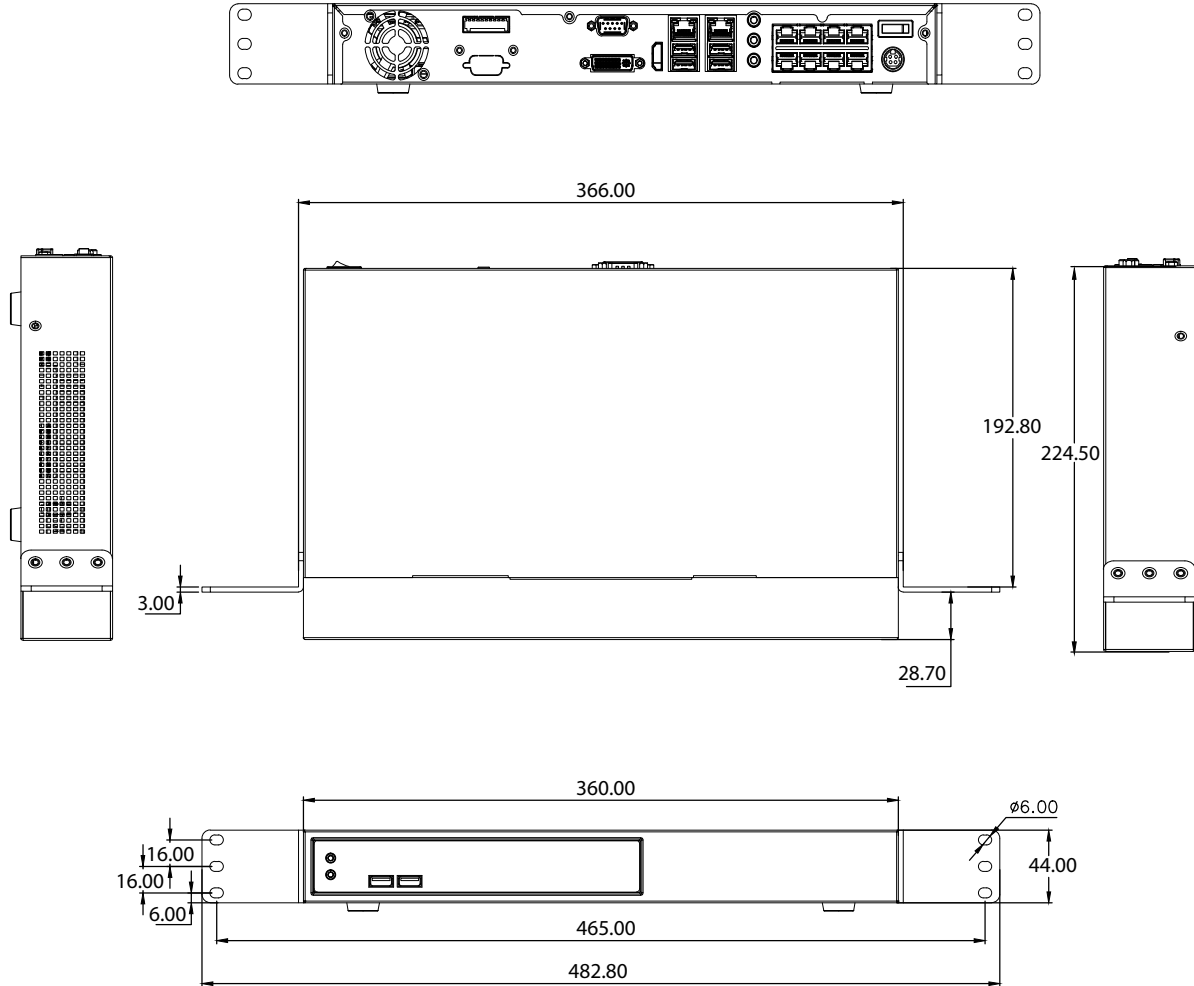

Mechanical Dimensions

Desktop Model

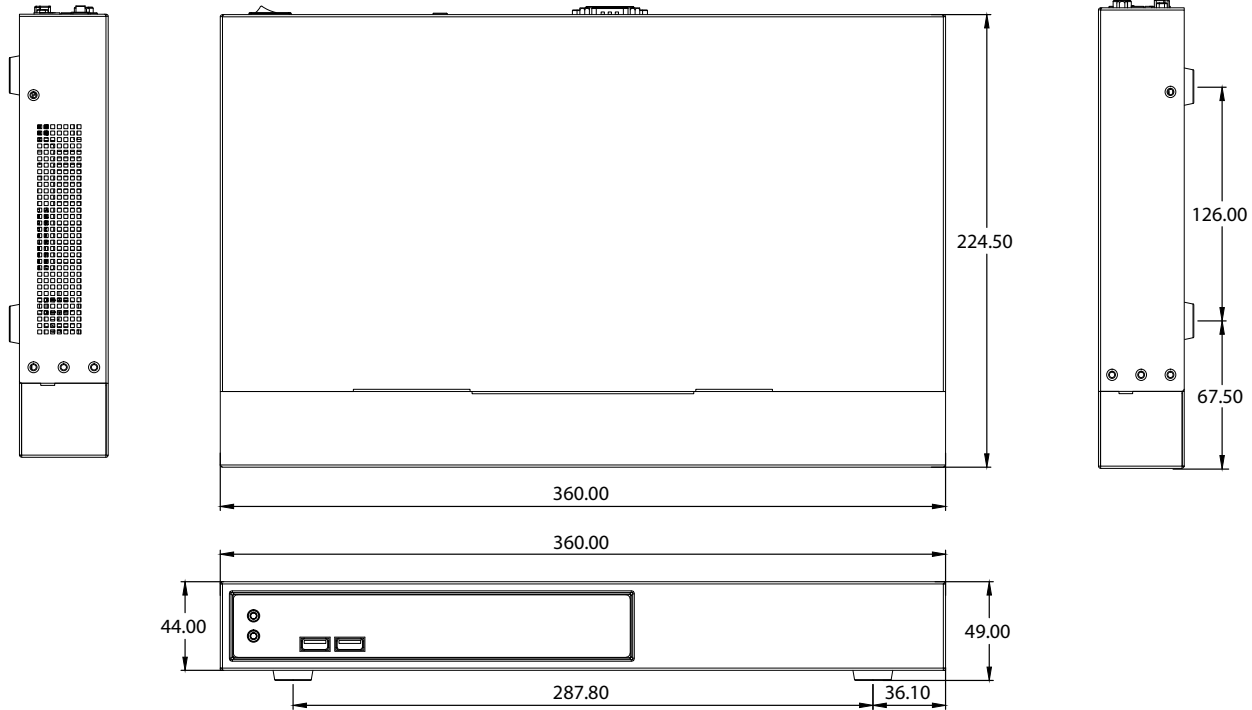
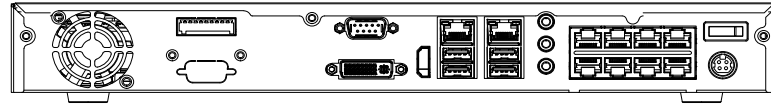

Mechanical Dimensions

Wallmount Model

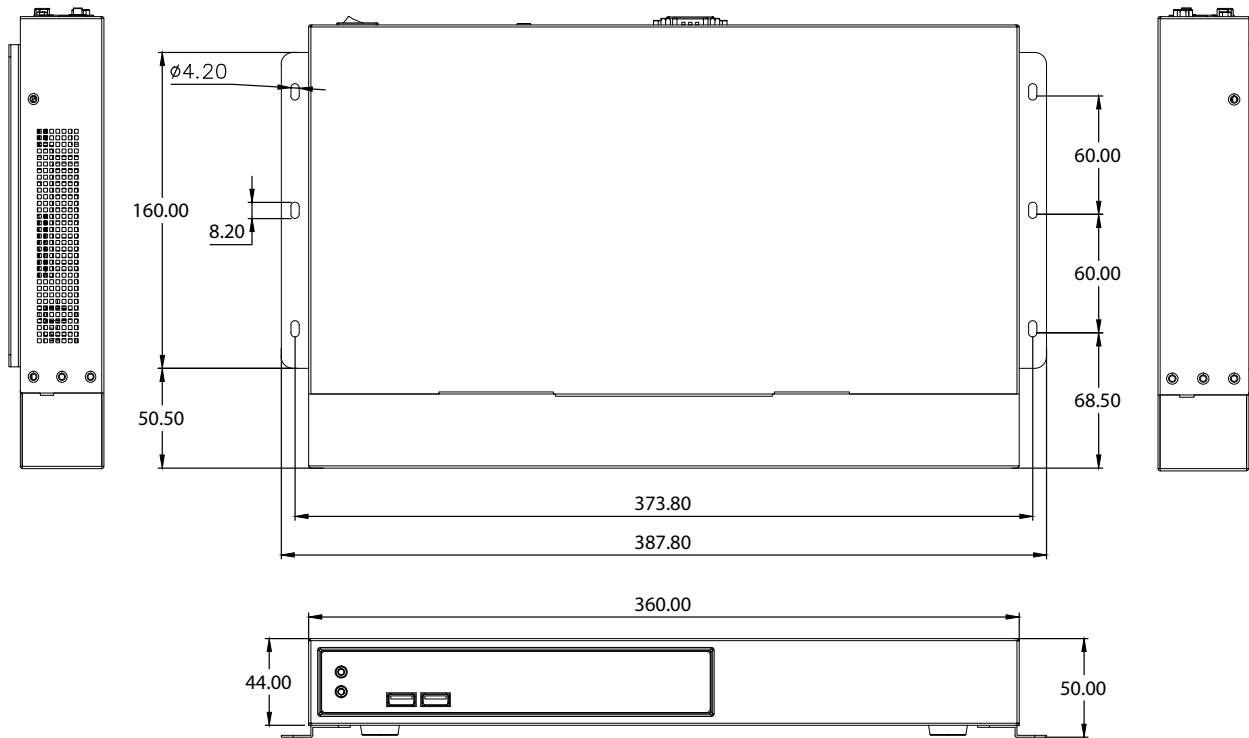
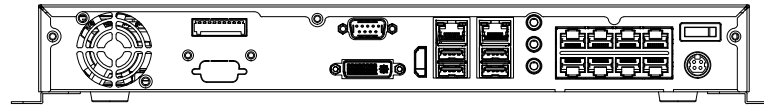

CHAPTER 2: JUMPERS AND CONNECTORS

This chapter describes how to set the jumpers and connectors on the NViS 1482 series motherboard.

Before You Begin

- Ensure you have a stable, clean working environment. Dust and dirt can get into components and cause a malfunction. Use containers to keep small components separated.
- Adequate lighting and proper tools can prevent you from accidentally damaging the internal components. Most of the procedures that follow require only a few simple tools, including the following:
 - A Philips screwdriver
 - A flat-tipped screwdriver
 - A set of jewelers screwdrivers
 - A grounding strap
 - An anti-static pad
- Using your fingers can disconnect most of the connections. It is recommended that you do not use needle-nosed pliers to disconnect connections as these can damage the soft metal or plastic parts of the connectors.
- Before working on internal components, make sure that the power is off. Ground yourself before touching any internal components, by touching a metal object. Static electricity can damage many of the electronic components. Humid environments tend to have less static electricity than

dry environments. A grounding strap is warranted whenever danger of static electricity exists.

Precautions

Computer components and electronic circuit boards can be damaged by discharges of static electricity. Working on computers that are still connected to a power supply can be extremely dangerous.

Follow the guidelines below to avoid damage to your computer or yourself:

- Always disconnect the unit from the power outlet whenever you are working inside the case.
- If possible, wear a grounded wrist strap when you are working inside the computer case. Alternatively, discharge any static electricity by touching the bare metal chassis of the unit case, or the bare metal body of any other grounded appliance.
- Hold electronic circuit boards by the edges only. Do not touch the components on the board unless it is necessary to do so. Don't flex or stress the circuit board.
- Leave all components inside the static-proof packaging that they shipped with until they are ready for installation.
- Use correct screws and do not over tighten screws.

Jumper Settings

A jumper is the simplest kind of electric switch. It consists of two metal pins and a cap. When setting the jumpers, ensure that the jumper caps are placed on the correct pins. When the jumper cap is placed on both pins, the jumper is short. If you remove the jumper cap, or place the jumper cap on just one pin, the jumper is open.

Refer to the illustrations below for examples of what the 2-pin and 3-pin jumpers look like when they are short (on) and open (off).

Two-Pin Jumpers: Open (Left) and Short (Right)

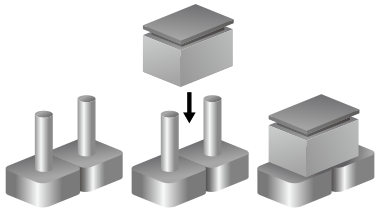

Three-Pin Jumpers: Pins 1 and 2 are Short

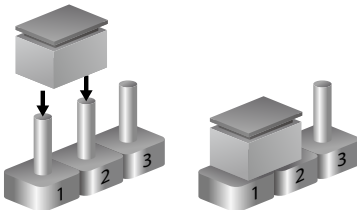

Locations of the Jumpers and Connectors

The figure below shows the location of the jumpers and connectors.

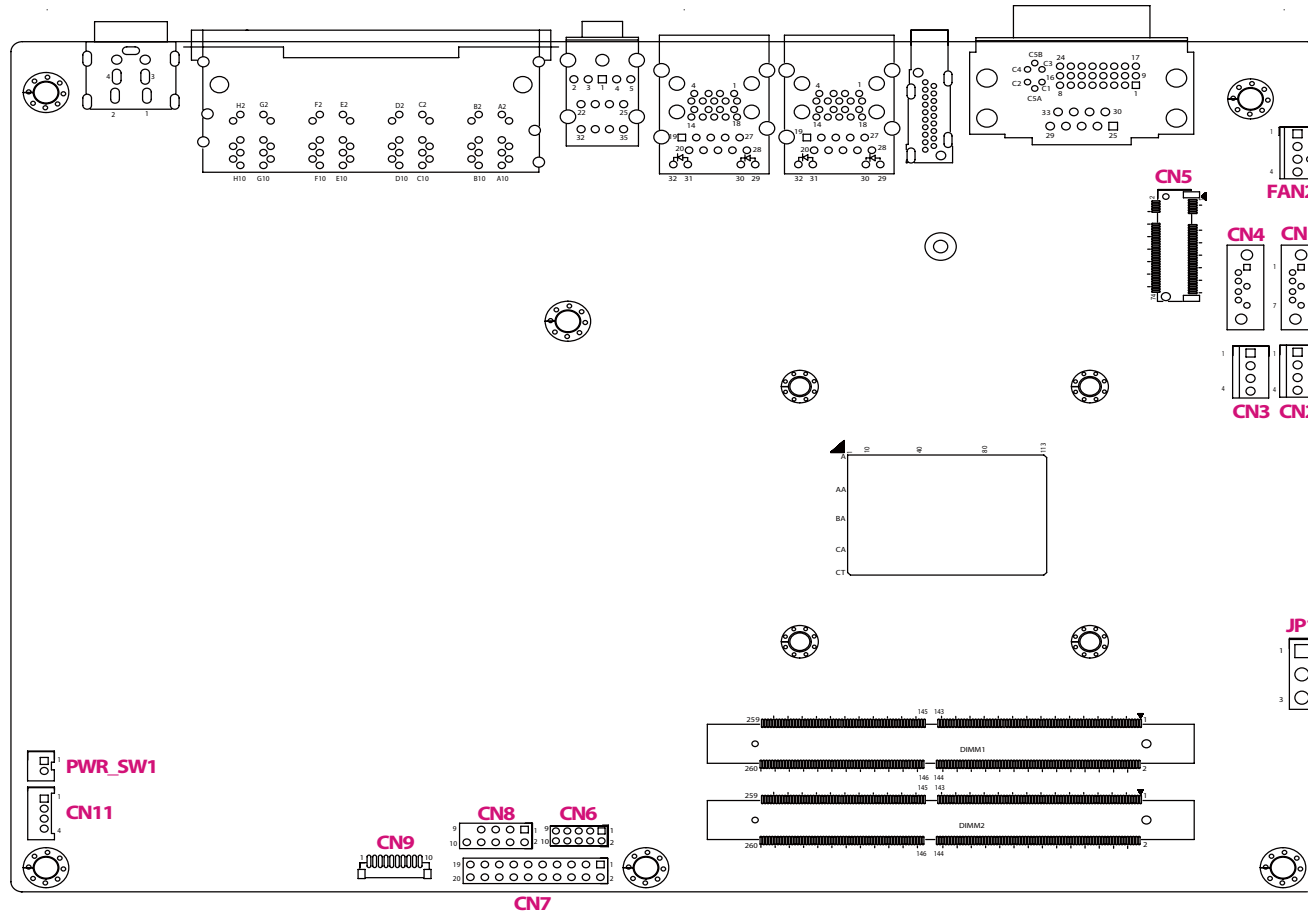

Jumpers

Clear CMOS

Connector type: 1x3 3-pin header

Connector location: JP1

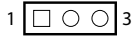

Pin	Settings
1-2	Normal
2-3	Clear CMOS

1-2 On: default

Connector Pin Definitions

54V Power-in Connector (Outside)

Connector type: 2x2 4-pin header

Connector location: CON6

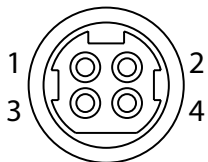

Pin	Definition	Pin	Definition
1	54V-in	2	54V-in
3	GND	4	GND

PoE LAN 8 Ports RJ45 Connector

Connector type: Phone Jack RJ45 2x4 Port PoE

Connector location: CON5

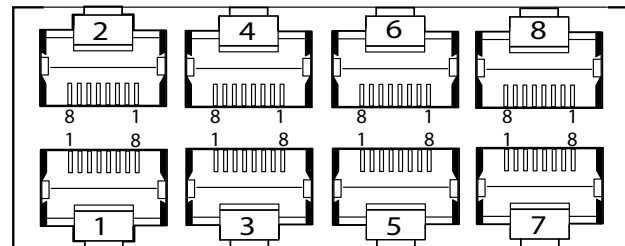

GPIO Connector

Connector type: 2x5 10-pin header

Connector location: CN8

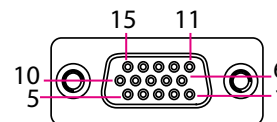
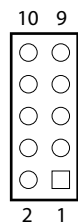

Pin	Definition	Pin	Definition
1	5.0V	2	GND
3	GPIO80	4	GPIO84
5	GPIO81	6	GPIO85
7	GPIO82	8	GPIO86
9	GPIO83	10	GPIO87

Pin	Definition	Pin	Definition
1	5.0V	2	GPIO84
3	GPIO85	4	GPIO86
5	GPIO87	6	GND
7	GPIO80	8	GPIO81
9	GPIO82	10	GPIO83
11	--	12	--
13	--	14	--
15	--		

System Fan

Connector type: 1x4 4-pin header

Connector location: FAN2

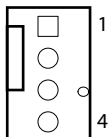

Pin	Definition	Pin	Definition
1	GND	2	+12V
3	SYS2_FAN_TACO	4	SYS2_FAN_PWM

USB2.0 Connector

Connector type: 2x5 10-pin header

Connector location: CN6

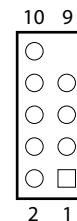

Pin	Definition	Pin	Definition
1	V5P0_USB2_HDR	2	V5P0_USB2_HDR
3	USB2_4_DN_CM	4	USB2_5_DN_CM
5	USB2_4_DP_CM	6	USB2_5_DP_CM
7	GND	8	GND
9	X	10	N/C

HDD/PWR LED Wire

Connector type: 1x4 4-pin header

Connector location: CN11

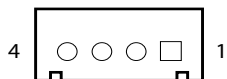

Pin	Definition	Pin	Definition
1	LED_PWR_PU	2	LED_PWR_LOGIC_N
3	LED_HDD_LOGIC_N	4	LED_HDD_PU

SATA Connector

Connector type: 1x4 4-pin header

Connector location: CN1

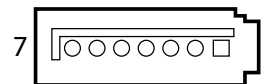

Pin	Definition	Pin	Definition
1	GND	2	SATA_CON1_TXP
3	SATA_CON1_TXN	4	GND
5	SATA_CON1_RXN	6	SATA_CON1_RXP
7	GND		

SATA Connector

Connector type: 1x4 4-pin header

Connector location: CN4

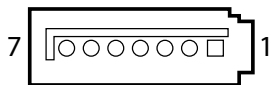

Pin	Definition	Pin	Definition
1	GND	2	SATA_CON2_TXP
3	SATA_CON2_TXN	4	GND
5	SATA_CON2_RXN	6	SATA_CON2_RXP
7	GND		

SATA Power Connector

Connector type: 1x4 4-pin header

Connector location: CN2, CN3

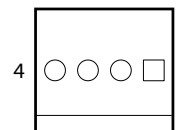

Pin	Definition	Pin	Definition
1	V12P0_SATA	2	GND
3	GND	4	V5P0_SATA

Audio Connectors

Connector location: AUDIO1

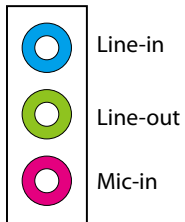

Power SW Connector

Connector type: 1x2 2-pin header
Connector location: PWR_SW1

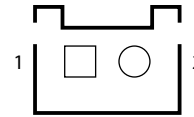

Pin	Definition	Pin	Definition
1	GND	2	PWRBTN_N

COM Port Connector

Connector type: 1x10 10-pin header

Connector location: CN9

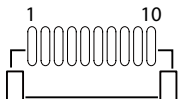

Pin	Definition	Pin	Definition
1	SP2_DCD_N	2	SP2_RXD
3	SP2_TXD	4	SP2_DTR_N
5	GND	6	SP2_DSR_N
7	SP2_RTS_N	8	SP2_CTS_N
9	SP2_RI_N	10	GND

Debug Port Connector

Connector type: 1x10 10-pin header

Connector location: ESPI_DB1

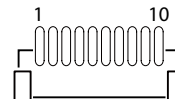

Pin	Definition	Pin	Definition
1	GND	2	PMC_PLTRST_N
3	ESPI_CLK	4	ESPI_CS0_N
5	ESPI_IO3	6	ESPI_IO2
7	ESPI_IO1	8	ESPI_IO0
9	ESPI_RST0_N	10	V3P3A

LAN1 Connector and USB 3.0 Ports

Connector type: RJ45 port with LEDs

Dual USB3.0 ports

Connector location: CON3

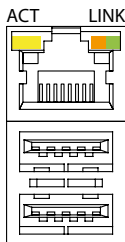

Act	Status
Yellow	Data activity
Off	No activity

Link	Status
Steady Green	2.5Gbps network link
Steady Orange	1000Mbps network link
Off	100Mbps or no link

LAN2 Connector and USB 3.0 Ports

Connector type: RJ45 port with LEDs

Dual USB3.0 ports

Connector location: CON4

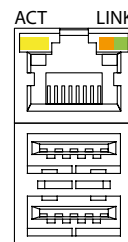

Act	Status
Yellow	Data activity
Off	No activity

Link	Status
Steady Green	1Gbps network link
Steady Orange	100Mbps network link
Off	10Mbps or no link

SPI BIOS Update Connector

Connector type: 2x4 8-pin header

Connector location: JP3

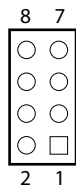

Pin	Definition	Pin	Definition
1	V3P3_V1P8_SPI	2	SPIO_CS_N
3	SPIO_HOLD_N	4	SPIO_MISO_N
5	FSPI_CLK_SPIO	6	SPIO_WP_N
7	SPIO_MOSI_N	8	GND

HDMI Connector

Connector type: HDMI

Connector location: CON2

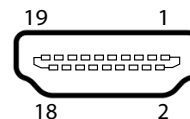

Pin	Definition	Pin	Definition
1	HDMI_TX2_DP_CM	2	GND
3	HDMI_TX2_DN_CM	4	HDMI_TX1_DP_CM
5	GND	6	HDMI_TX1_DN_CM
7	HDMI_TX0_DP_CM	8	GND
9	HDMI_TX0_DN_CM	10	HDMI_CLK_DP_CM
11	GND	12	HDMI_CLK_DN_CM
13	NC	14	NC
15	HDMI_RT_SCL_SNK	16	HDMI_RT_SDA_SNK
17	GND	18	V5P0_HDMI
19	HDMI_RT_HPD_SNK		

DVI-I and RS485 Connector

Connector location: CON1

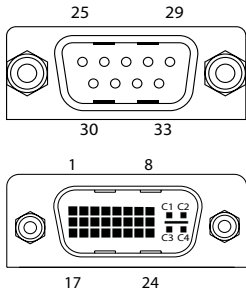

Pin	Definition	Pin	Definition
1	DVI_D2_N	2	DVI_D2_P
3	GND	4	NC
5	NC	6	DVI_DDC_SCL
7	DVI_DDC_SDA	8	VGA_VSYNC_C
9	DVI_D1_N	10	DVI_D1_P
11	GND	12	NC
13	NC	14	+DVI_5V
15	GND	16	DVI_HPD_C
17	DVI_D0_N	18	DVI_D0_P
19	GND	20	VGA_DDCCLK_C
21	VGA_DDCDATA_C	22	GND
23	DVI_CK_P	24	DVI_CK_N
25	SP1_DCD_N	26	SP1_RXD
27	SP1_TXD	28	SP1_DTR_N
29	GND	30	SP1_DSR_N
31	SP1_RTS_N	32	SP1_CTS_N

Pin	Definition	Pin	Definition
33	SP1_R1_N	C1	VGA_RED_C
C2	VGA_GREEN_C	C3	VGA_BLUE_C
C4	VGA_HSYNC_C	C5A	VGA_GND
C5B	GND		

POE 8 Ports LAN LED Connector

Connector type: 2x10 20-pin header

Connector location: CN7

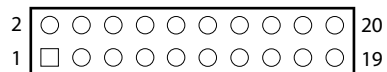

Pin	Definition	Pin	Definition
1	V3P3_IP403	2	V3P3_IP403
3	P1LINK_ACT	4	POE_P1_STATE
5	P2LINK_ACT	6	POE_P2_STATE
7	P3LINK_ACT	8	POE_P3_STATE
9	P4LINK_ACT	10	POE_P4_STATE
11	P5LINK_ACT	12	POE_P5_STATE
13	P6LINK_ACT	14	POE_P6_STATE
15	P7LINK_ACT	16	POE_P7_STATE
17	P8LINK_ACT	18	POE_P8_STATE
19	V3P3_IP403	20	V3P3_IP403

M.2 B Key Connector

Connector location: CN6

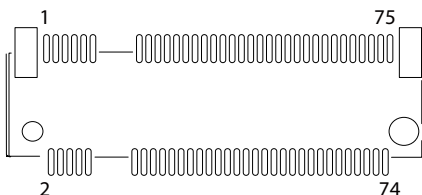

Pin	Definition	Pin	Definition
1	NC	2	V3P3A_M2E
3	GND	4	V3P3A_M2E
5	GND	6	NC
7	NC	8	NC
9	NC	10	M2_SATA_LED_N
11	NC	12	CONNECTOR KEY
13	CONNECTOR KEY	14	CONNECTOR KEY
15	CONNECTOR KEY	16	CONNECTOR KEY
17	CONNECTOR KEY	18	CONNECTOR KEY
19	CONNECTOR KEY	20	NC
21	NC	22	NC
23	NC	24	NC
25	NC	26	NC
27	GND	28	NC
29	NC	30	NC
31	NC	32	NC

Pin	Definition	Pin	Definition
33	GND	34	NC
35	NC	36	NC
37	NC	38	SATA_DEVSLP0
39	GND	40	NC
41	M2_SATA_RP	42	NC
43	M2_SATA_RN	44	NC
45	GND	46	NC
47	M2_SATA_TN	48	NC
49	M2_SATA_TP	50	NC
51	GND	52	NC
53	NC	54	NC
55	NC	56	MFG_DATA
57	GND	58	MFG_CLK
59	NC	60	NC
61	NC	62	NC
63	NC	64	NC
65	NC	66	NC
67	NC	68	M2E_SUSCLK
69	M2E_SEL_N	70	V3P3A_M2E
71	GND	72	V3P3A_M2E
73	GND	74	V3P3A_M2E
75	NC		

PoE Switch Action Guidance

8ch PoE ports 10/100 Mbps, 802.3af/at compliance with a total of 120W max (PSE)

- 802.3af support 8port @ 15W
- 802.3at support 4port @ 30W

PoE Switch Connector Define (Rear IO)

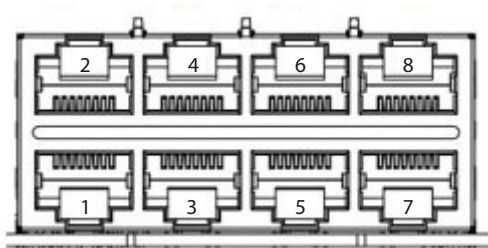

PoE Switch LED Indicator Status (Front Side)



- When the cable is plugged into the PoE port and if the device is detected, then the LED will indicate the corresponding port.
- When PoE overload >120W, the LED of the last plug in PoE port will blink.

PoE Switch Deployment

1. AF Mode

Port 1, 2, 3, 4, 5, 6, 7, 8

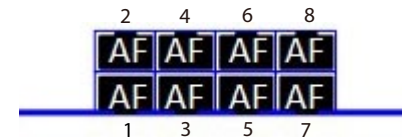

2. AT Mode

Port 1, 2, 3, 4

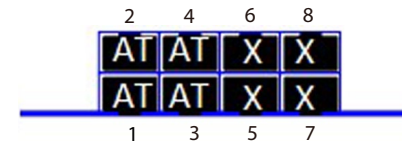

Port 3, 4, 5, 6

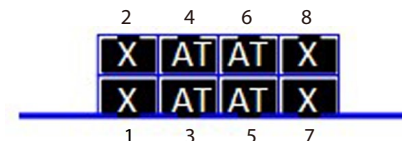

Port 5, 6, 7, 8

3AT + 2AF

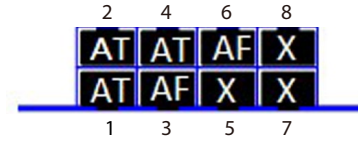
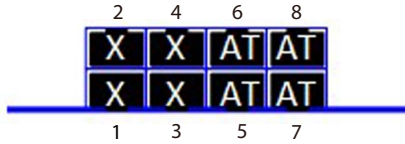

3. AF/AT Multi-mode

1AT + 6AF

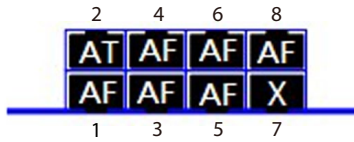

2AT + 4AF

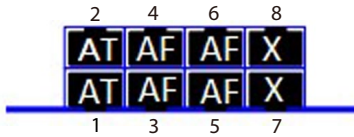

Block Diagram

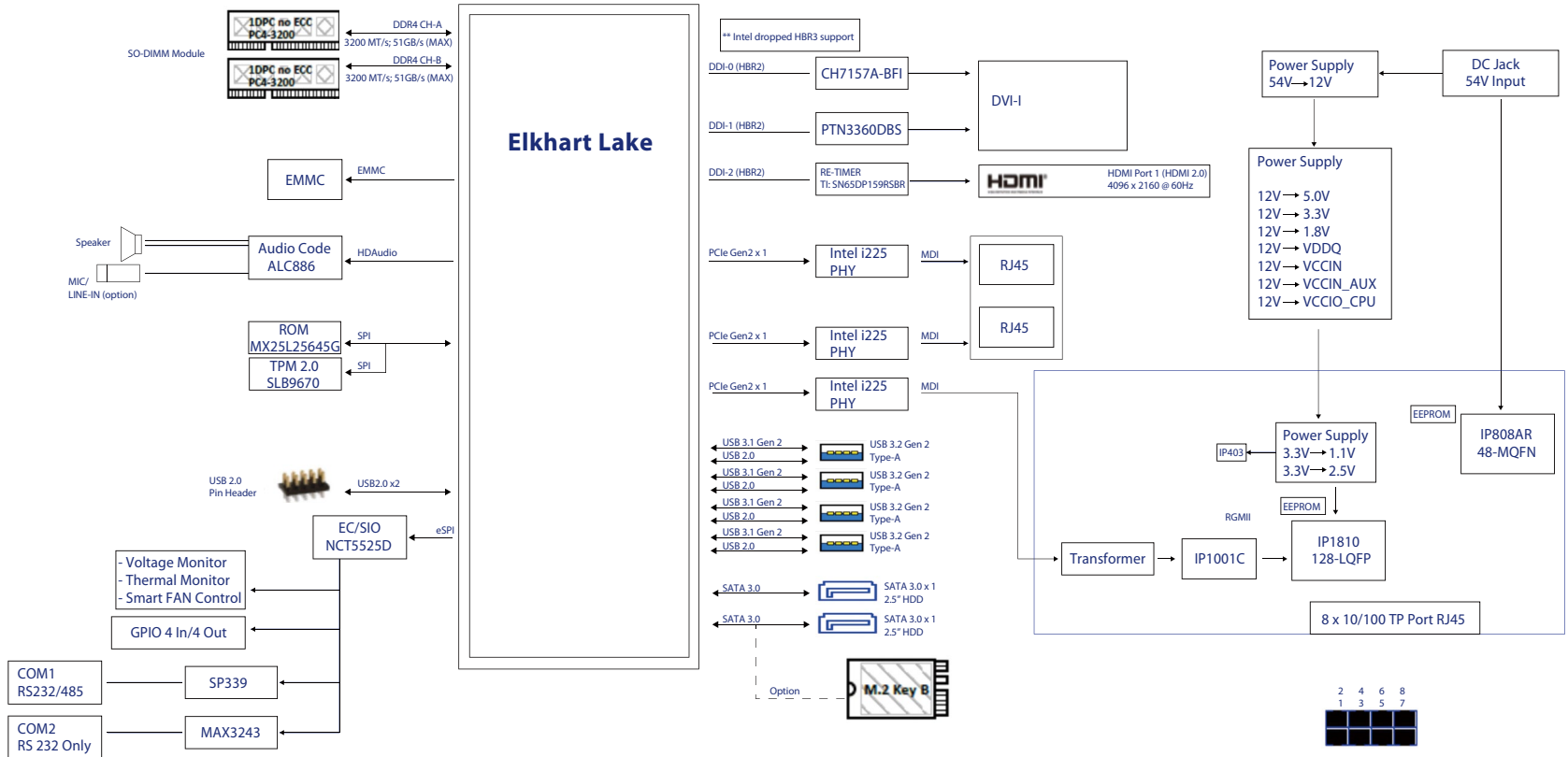

CHAPTER 3: SYSTEM SETUP

Removing the Chassis Cover



Prior to removing the chassis cover, make sure the unit's power is off and disconnected from the power sources to prevent electric shock or system damage.

1. Remove the 11 screws on the system's top cover. (Out of the 11 screws, there are 6 long screws and 5 short screws.)



Short screws

Long screws

2. Remove the top cover.



Short screws

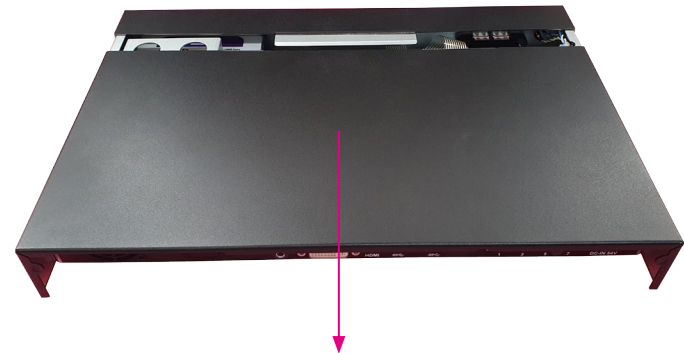

Installing the 3.5" HDD

1. Remove the HDD bracket.

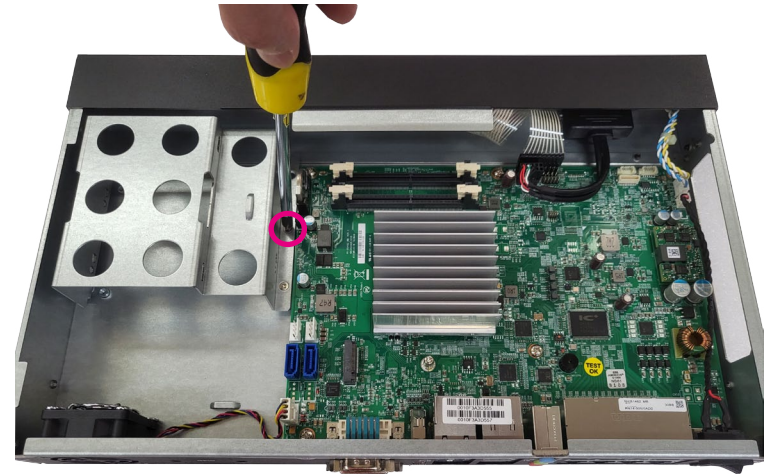
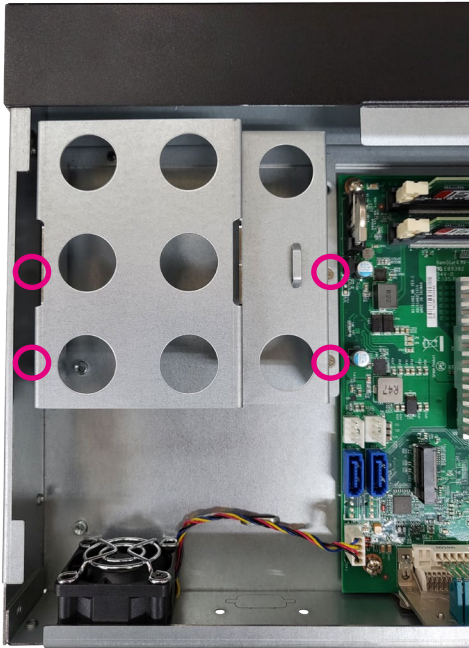

2. Set 3.5" HDD into the HDD bracket. (Use #6-32 type screw)

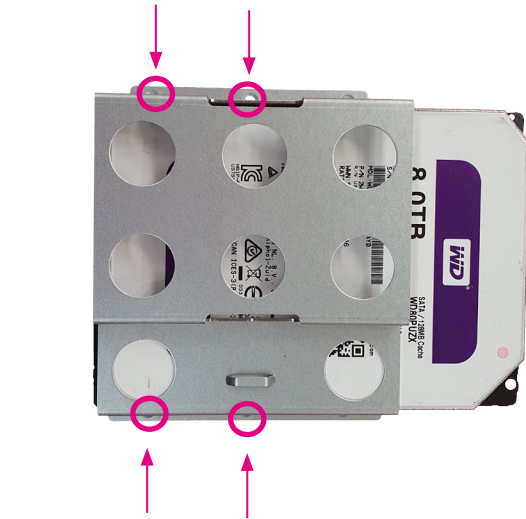

#6-32 screw x4 (3.5" HDD lock on bracket)



3. Plug in the HDD SATA cable and SATA power cable, install the HDD set into the system.

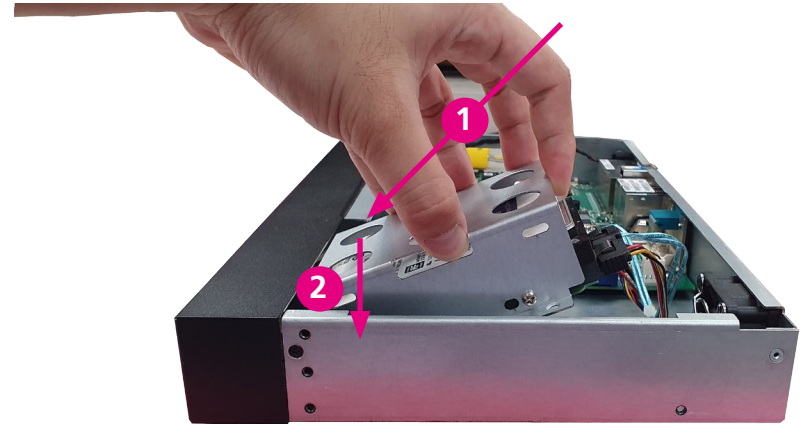
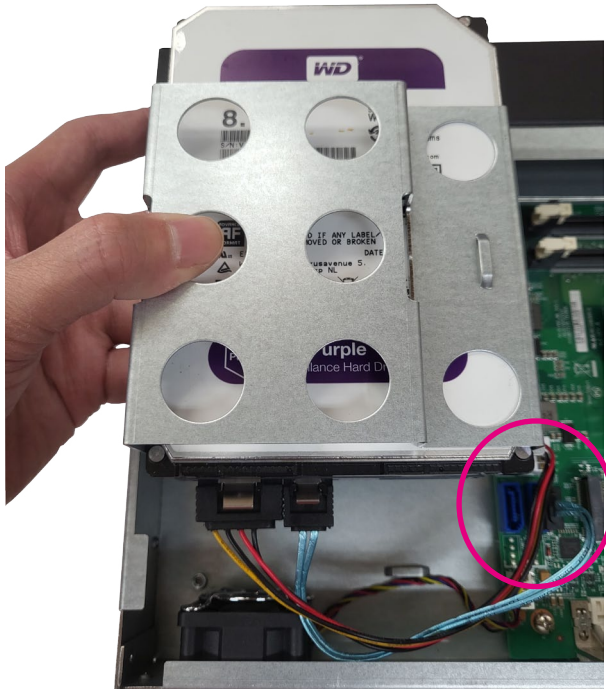

Note: HDD SATA cable should be installed at CN4 of the mainboard. SATA power cable should be installed at CN3 of the mainboard.

4. Lock the screw.



5. Tightening Cable Guidance For 3.5" HDD

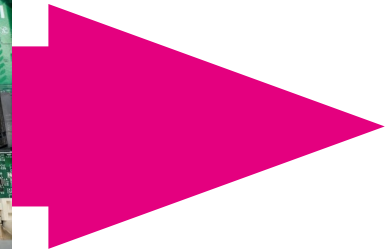
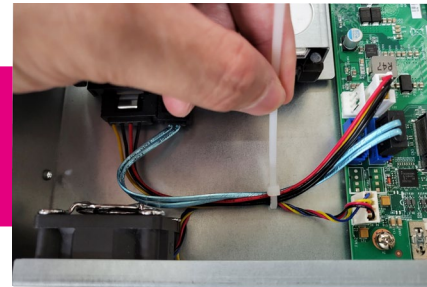
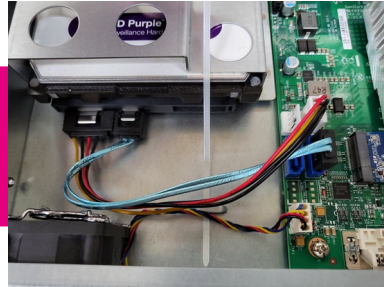
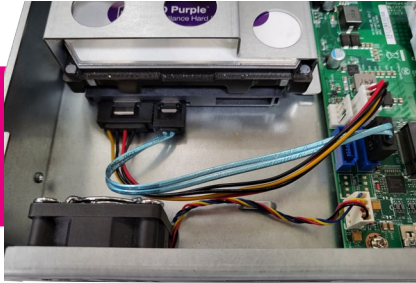

Complete!

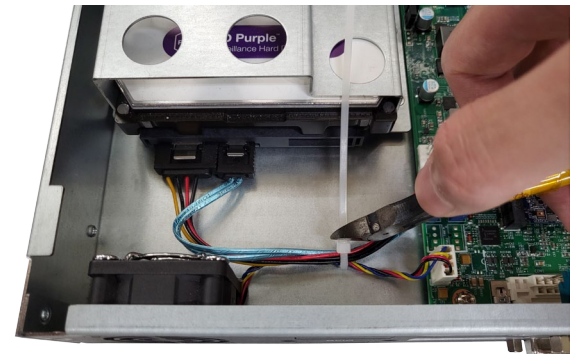

6. Complete!

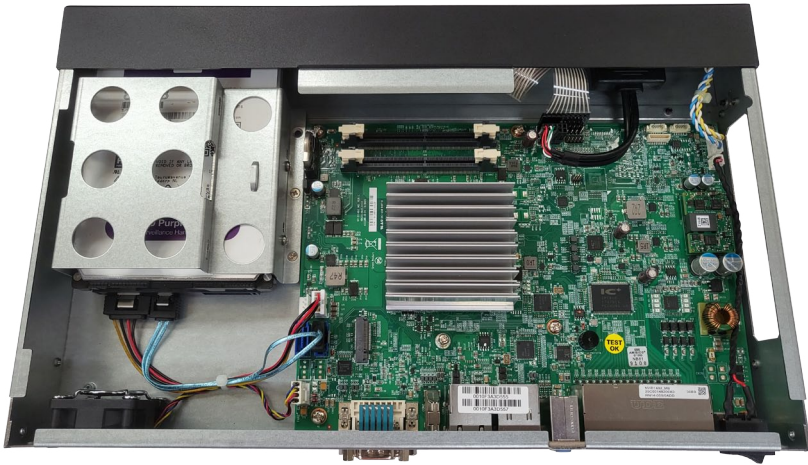

Installing the 2.5" SSD/HDD

1. Remove the HDD bracket.

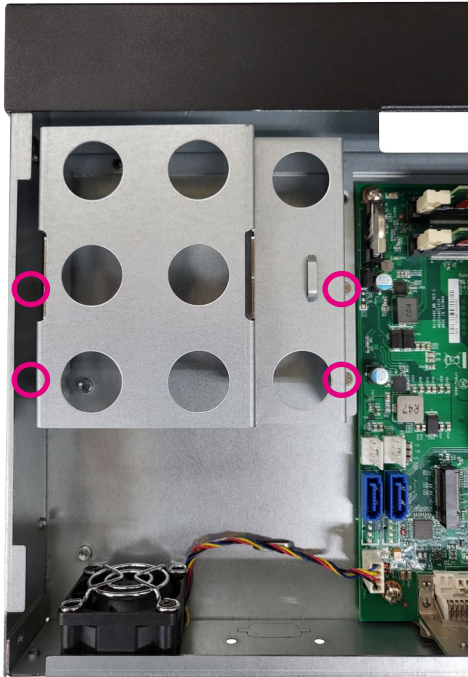

Note:
The SATA port CN1 and M.2 slot cannot be used simultaneously.

2. Set 2.5" SSD/HDD into the HDD bracket. (Use M3 type screw)

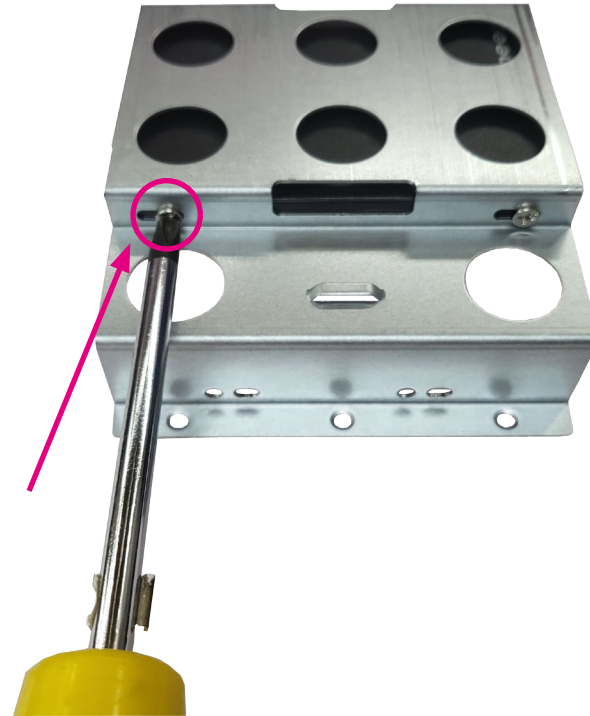
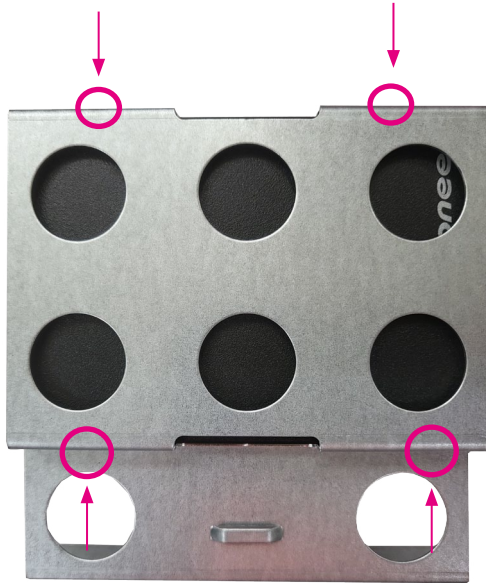

M3 screw x4 (2.5" HDD lock on bracket)

3. Plug in the SATA cable and SATA power cable, install the SSD/HDD set into the system.

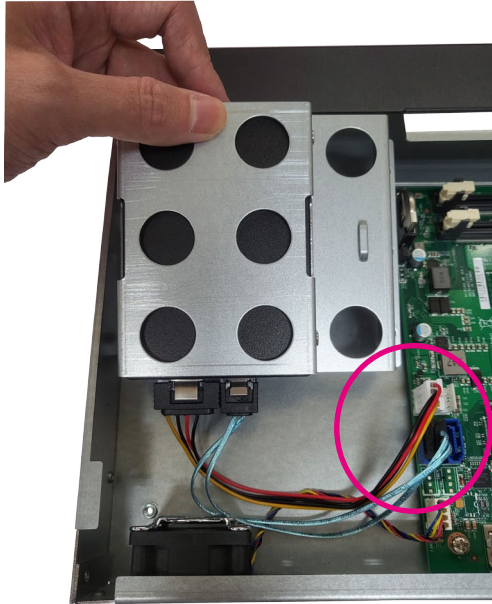

4. Lock the screw.

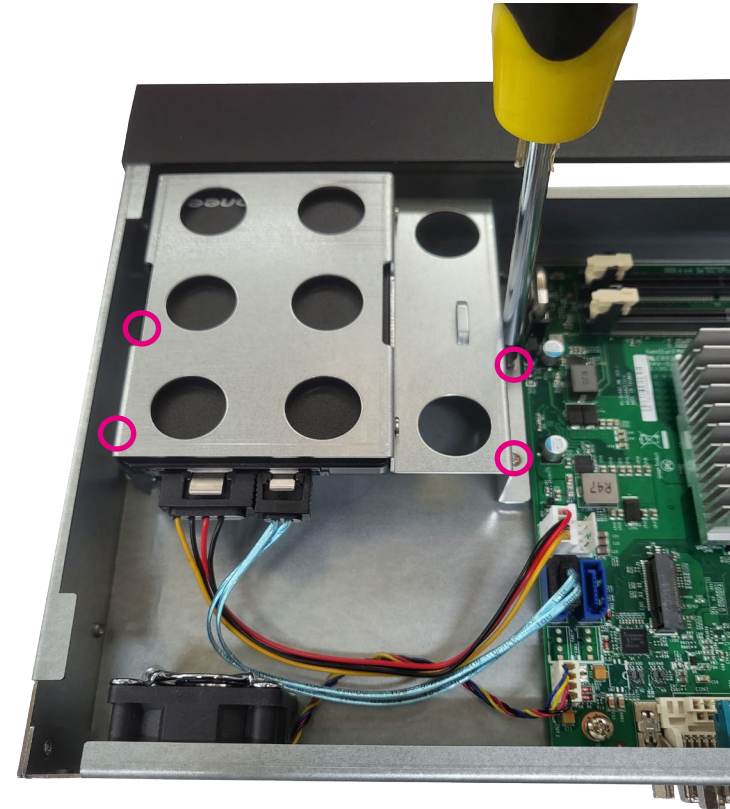

Note: SATA cable should be installed at CN1 of the mainboard. SATA power cable should be installed at CN2 of the mainboard.

5. Tightening Cable Guidance For 2.5" SSD/HDD

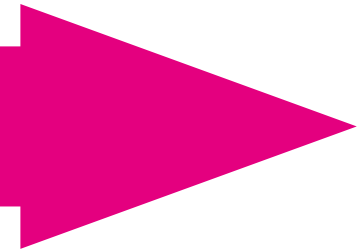
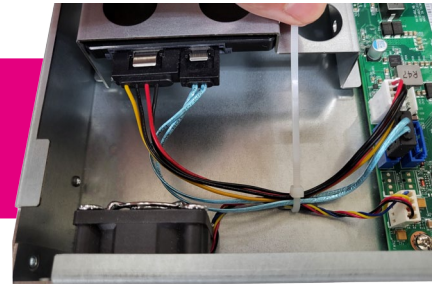
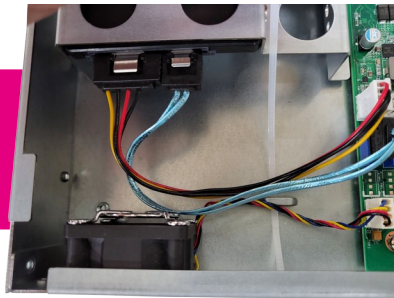
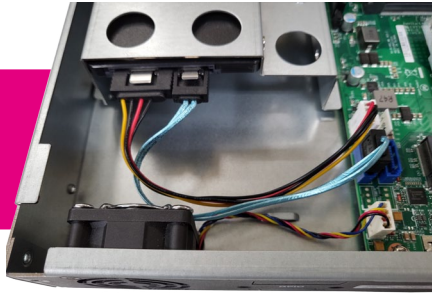

Complete!

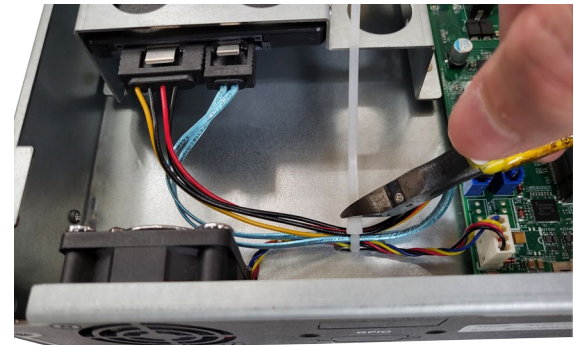

6. Complete!

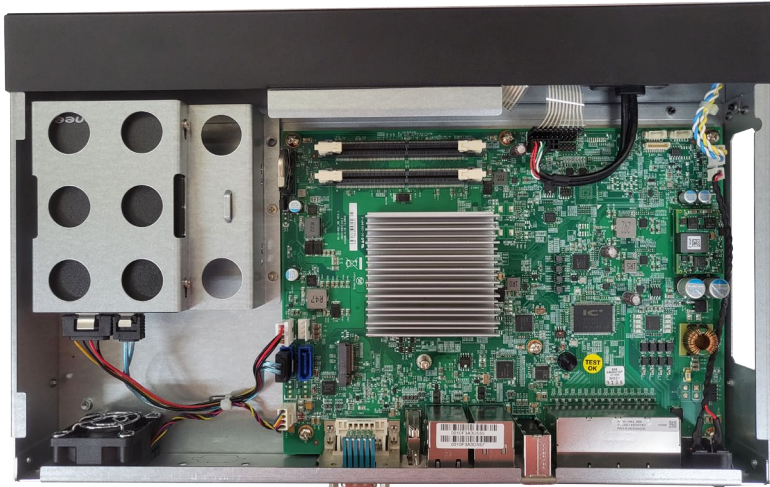

Installing M.2 SSD

1. First, remove the screw on the board.

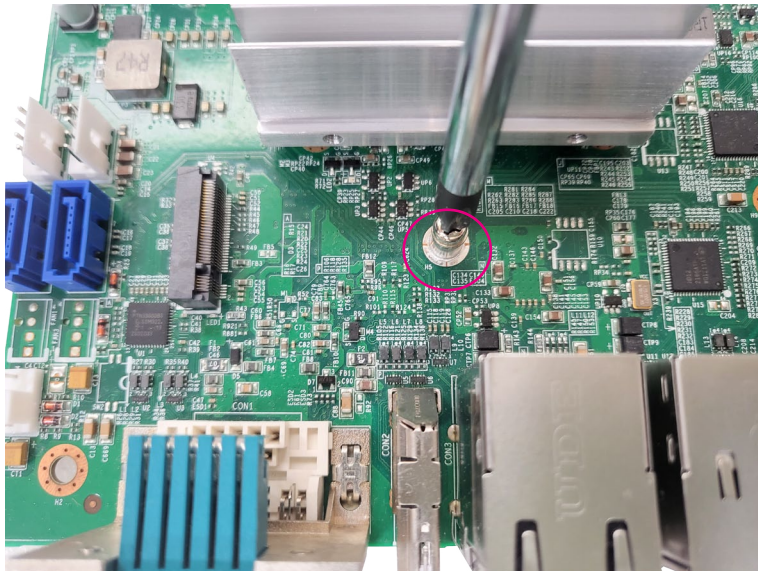

2. Insert the M.2 SSD into the M.2 slot at a 45 degree angle until the gold-plated connector on the edge of the module completely disappears inside the slot.

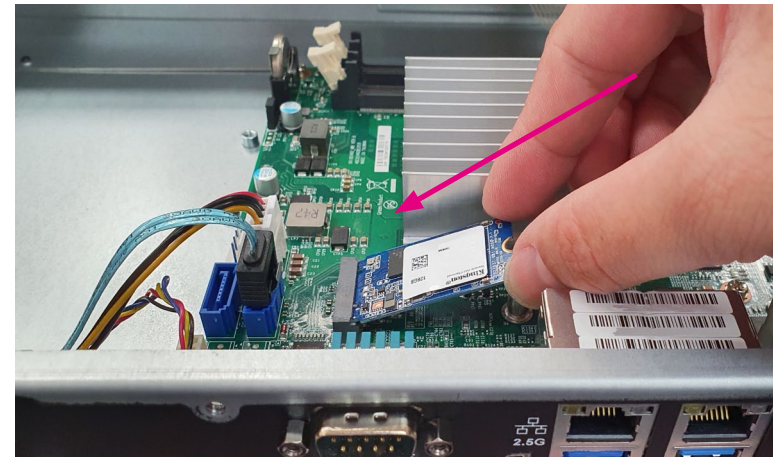

Note:

The SATA port CN1 and M.2 slot cannot be used simultaneously.

3. With the module fully inserted, tighten a screw into the mounting hole on the module to secure it.

4. Complete!

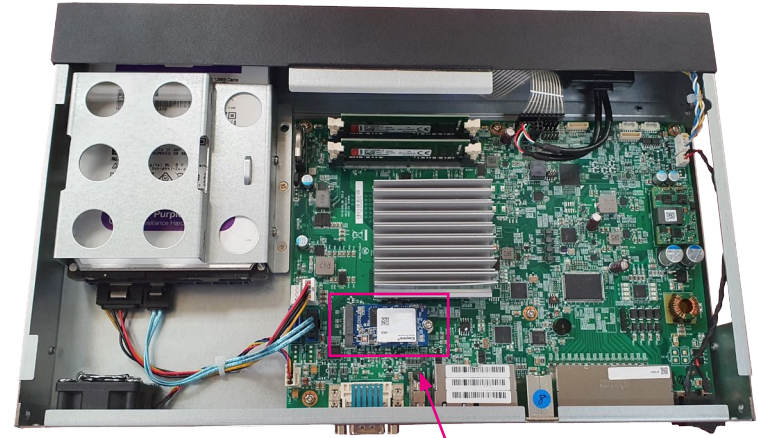

M.2 2242 B-key

Installing Memory SO-DIMM (Use DDR4 SO-DIMM)

1. Locate the DIMM memory sockets.

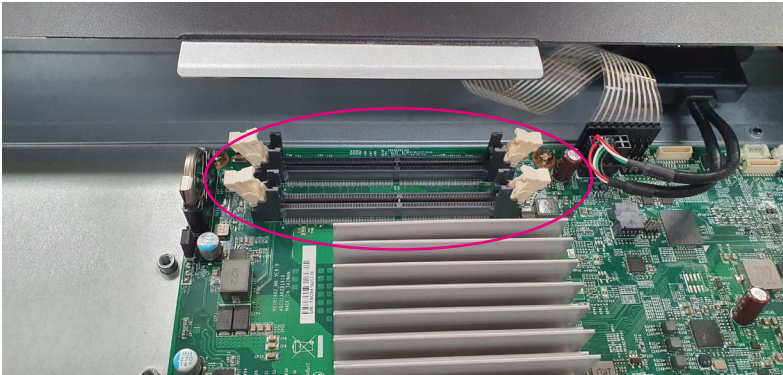

2. Release the locks on the DIMM memory sockets. Insert the modules into the sockets at a 90 degree angle. Apply firm even pressure to each end of the modules until they slip into the sockets.

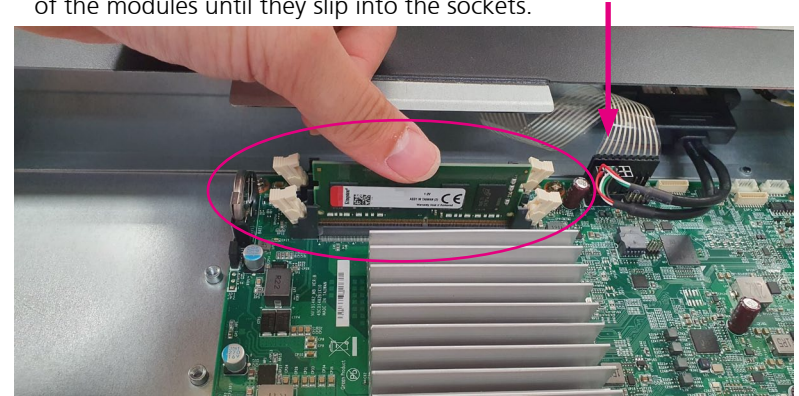

2. Release the locks on the second DIMM memory sockets. Insert the other module into the sockets also at a 90 degree angle. Apply firm even pressure to each end of the modules until they slip into the sockets.



4. Complete!

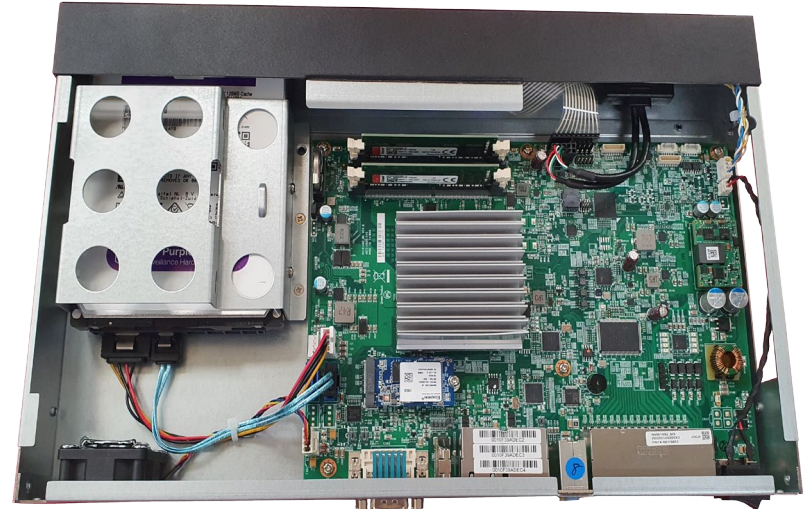

CHAPTER 4: BIOS SETUP

This chapter describes how to use the BIOS setup program for the NViS 1482 series. The BIOS screens provided in this chapter are for reference only and may change if the BIOS is updated in the future.

To check for the latest updates and revisions, visit the NEXCOM website at www.nexcom.com.tw.

About BIOS Setup

The BIOS (Basic Input and Output System) Setup program is a menu driven utility that enables you to make changes to the system configuration and tailor your system to suit your individual work needs. It is a ROM-based configuration utility that displays the system's configuration status and provides you with a tool to set system parameters.

These parameters are stored in non-volatile battery-backed-up CMOS RAM that saves this information even when the power is turned off. When the system is turned back on, the system is configured with the values found in CMOS.

With easy-to-use pull down menus, you can configure such items as:

- Hard drives, diskette drives, and peripherals
- Video display type and display options
- Password protection from unauthorized use
- Power management features

The settings made in the setup program affect how the computer performs. It is important, therefore, first to try to understand all the setup options, and second, to make settings appropriate for the way you use the computer.

When to Configure the BIOS

- This program should be executed under the following conditions:
 - When changing the system configuration
 - When a configuration error is detected by the system and you are prompted to make changes to the setup program
 - When resetting the system clock
 - When redefining the communication ports to prevent any conflicts
 - When making changes to the Power Management configuration
 - When changing the password or making other changes to the security setup

Normally, CMOS setup is needed when the system hardware is not consistent with the information contained in the CMOS RAM, whenever the CMOS RAM has lost power, or the system features need to be changed.

Default Configuration

Most of the configuration settings are either predefined according to the Load Optimal Defaults settings which are stored in the BIOS or are automatically detected and configured without requiring any actions. There are a few settings that you may need to change depending on your system configuration.

Entering Setup











When the system is powered on, the BIOS will enter the Power-On Self Test (POST) routines. These routines perform various diagnostic checks; if an error is encountered, the error will be reported in one of two different ways:

- If the error occurs before the display device is initialized, a series of beeps will be transmitted.
- If the error occurs after the display device is initialized, the screen will display the error message.

Powering on the computer and immediately pressing allows you to enter Setup.

Press the  key to enter Setup:

Legends

Key	Function
	Moves the highlight left or right to select a menu.
	Moves the highlight up or down between sub-menus or fields.
	Exits the BIOS Setup Utility.
	Scrolls forward through the values or options of the highlighted field.
	Scrolls backward through the values or options of the highlighted field.
	Selects a field.
	Displays General Help.
	Load previous values.
	Load optimized default values.
	Saves and exits the Setup program.
	Press <Enter> to enter the highlighted sub-menu

Scroll Bar

When a scroll bar appears to the right of the setup screen, it indicates that there are more available fields not shown on the screen. Use the up and down arrow keys to scroll through all the available fields.

Submenu

When “▶” appears on the left of a particular field, it indicates that a submenu which contains additional options are available for that field. To display the submenu, move the highlight to that field and press  .

BIOS Setup Utility

Once you enter the AMI BIOS Setup Utility, the Main Menu will appear on the screen. The main menu allows you to select from several setup functions and one exit. Use arrow keys to select among the items and press  to accept or enter the submenu.

Main

The Main menu is the first screen that you will see when you enter the BIOS Setup Utility.

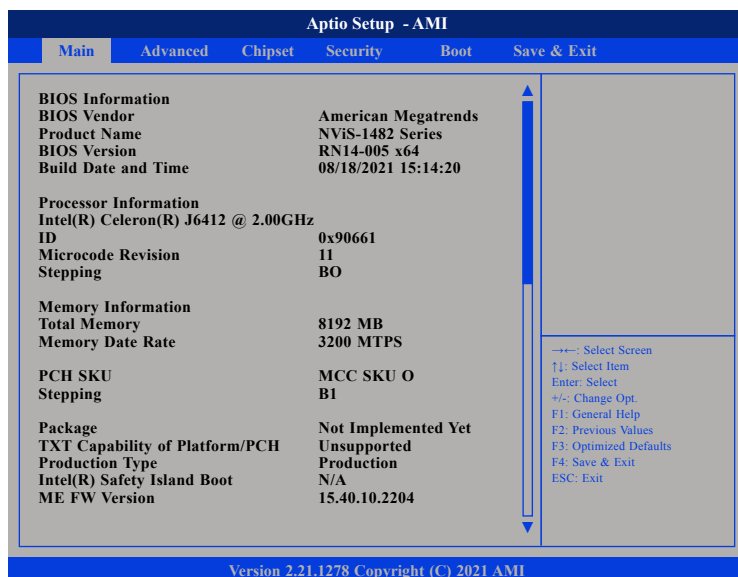

System Date

The date format is <day>, <month>, <date>, <year>. Day displays a day, from Monday to Sunday. Month displays the month, from January to December. Date displays the date, from 1 to 31. Year displays the year, from 1999 to 2099.

System Time

The time format is <hour>, <minute>, <second>. The time is based on the 24-hour military-time clock. For example, 1 p.m. is 13:00:00. Hour displays hours from 00 to 23. Minute displays minutes from 00 to 59. Second displays seconds from 00 to 59.

Advanced

The Advanced menu allows you to configure your system for basic operation. Some entries are defaults required by the system board, while others, if enabled, will improve the performance of your system or let you set some features according to your preference.



Setting incorrect field values may cause the system to malfunction.

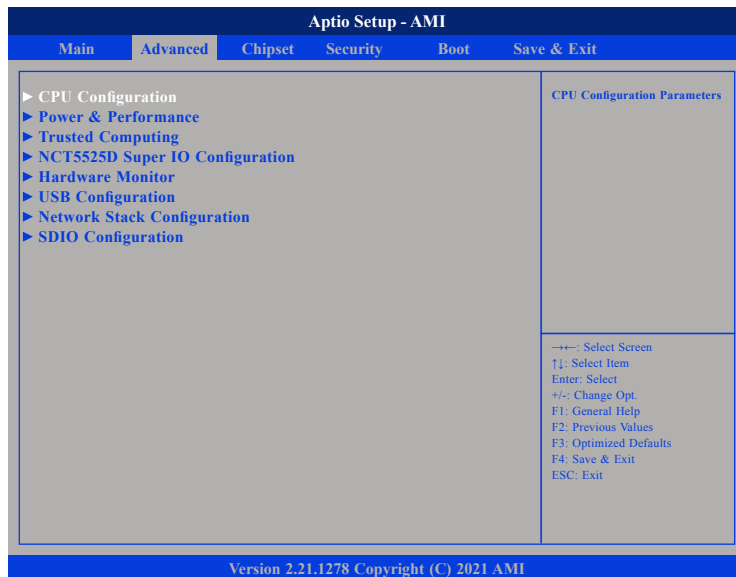

CPU Configuration

This section is used to view CPU status and configure CPU parameters.

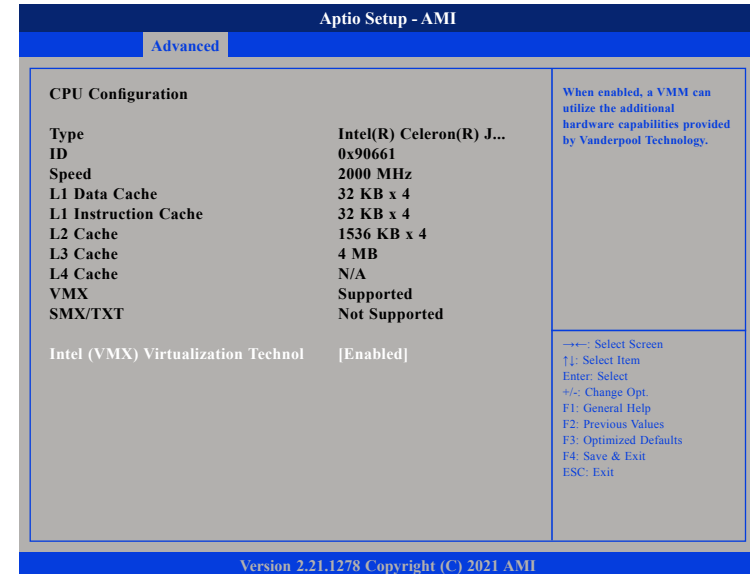

Intel® (VMX) Virtualization Technology

When this field is set to Enabled, the VMM can utilize the additional hardware capabilities provided by Vanderpool Technology.

Power & Performance

This section is used to configure the power management features of the CPU.

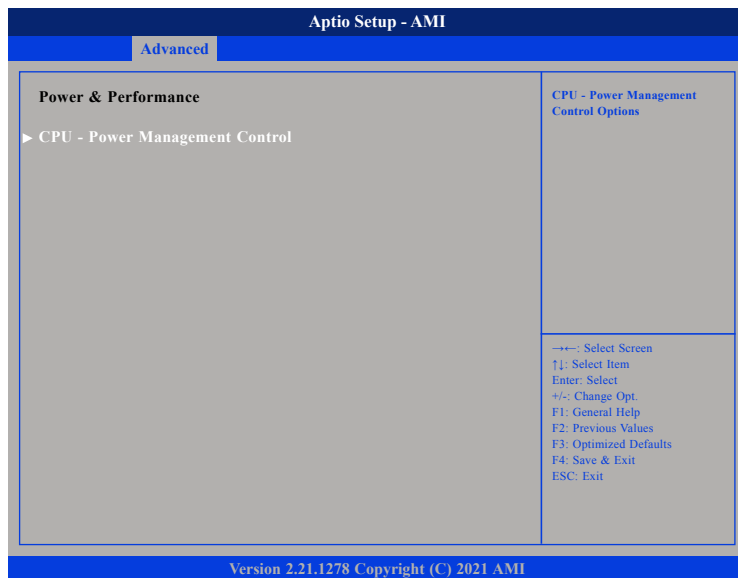

CPU - Power Management Control

Enters the CPU - Power Management Control sub-menu.

CPU - Power Management Control

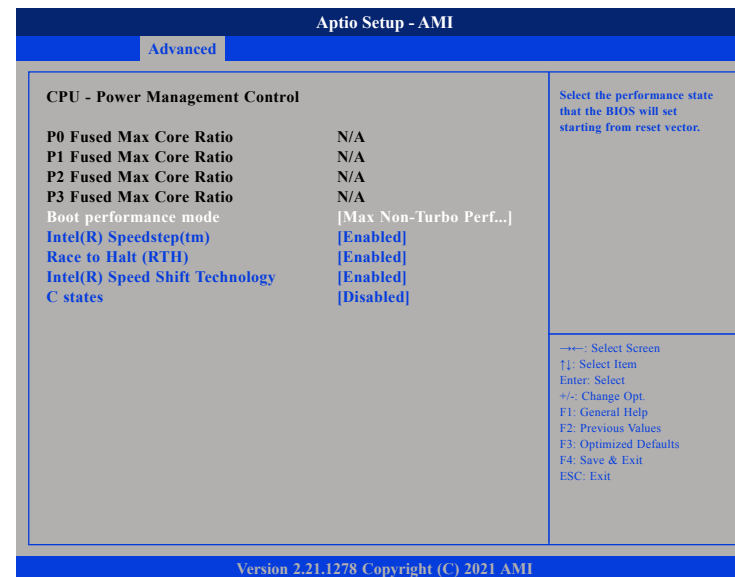

Boot Performance Mode

Configures the performance state that the BIOS will set before OS handoff.

Intel® Speedstep™

Enables or disables Intel SpeedStep technology.

Race to Halt (RTH)

Enables or disables RTH feature. RTH will dynamically increase CPU frequency in order to enter pkg C-State faster to reduce overall power.

Intel® Speed Shift Technology

Enables or disables Intel Speed Shift Technology support. Enabling it will expose the CPPC v2 interface to allow hardware controlled P-states.

C states

Enables or disables CPU C states support for power saving.

Trusted Computing

This section is used to configure Trusted Platform Module (TPM) settings.

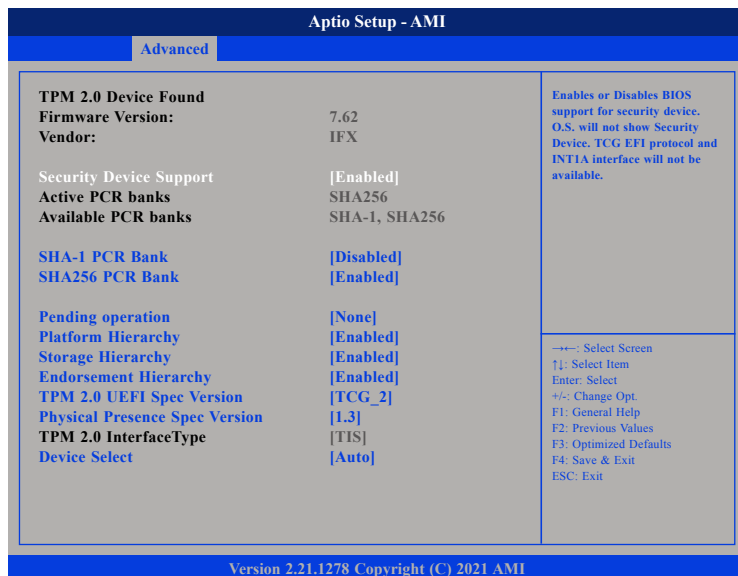

Security Device Support

Enables or disables BIOS support for security device.

SHA-1 PCR Bank

Enables or disables SHA-1 PCR bank.

SHA256 PCR Bank

Enables or disables SHA256 PCR bank.

Pending operation

Scheduling an operation for the security device.

Note: Your computer will reboot during restart in order to change state of security device.

Platform Hierarchy

Enables or disables platform hierarchy.

Storage Hierarchy

Enables or disables storage hierarchy.

Endorsement Hierarchy

Enables or disables endorsement hierarchy.

TPM 2.0 UEFI Spec Version

Select the TCG Spec Version Support.

TCG_1_2: the compatible mode for Win8/Win10.

TCG_2: Support new TCG2 protocol and event format for Win10 or later.

Physical Presence Spec Version

Select to tell O.S. to support PPI Spec Version 1.2 or 1.3.

Note some HCK tests might not support 1.3.

Device select

TPM 1.2 will restrict support to TPM 1.2 devices. TPM 2.0 will restrict support to TPM 2.0 devices. Auto will support both with the default set to TPM 2.0 devices if not found, TPM 1.2 devices will be enumerated.

NCT5525D Super IO Configuration

This section is used to configure the serial port.

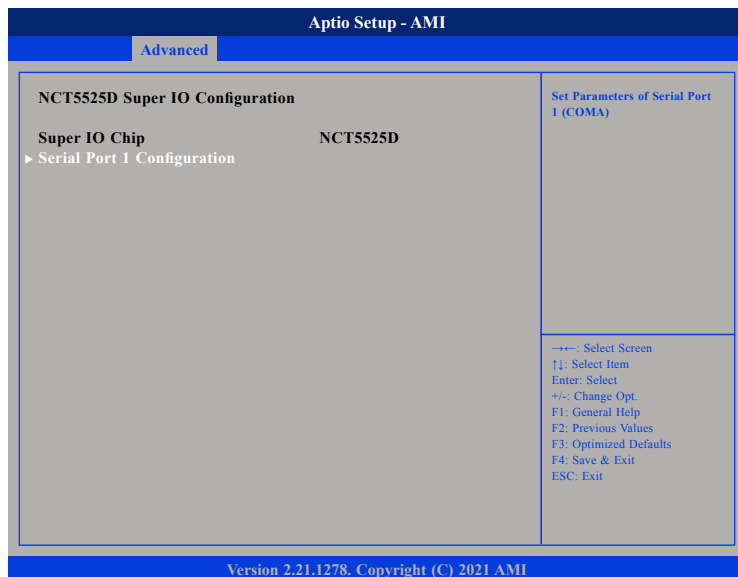

Super IO Chip

Displays the Super I/O chip used on the board.

Serial Port 1 Configuration

Configuration settings for serial port 1.

Serial Port 1 Configuration

This section is used to configure serial port 1.

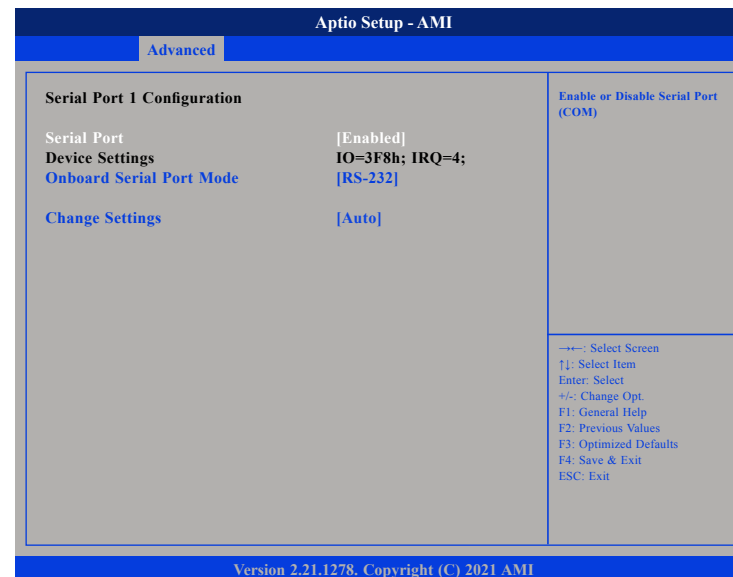

Serial Port

Enables or disables serial port.

Onboard Serial Port Mode

This field is used to configure the mode of serial port as RS232 or RS485.

Change Settings

Select an optimal settings for Super IO Device.

Hardware Monitor

This section is used to monitor hardware such as temperature, fan speed and voltages.

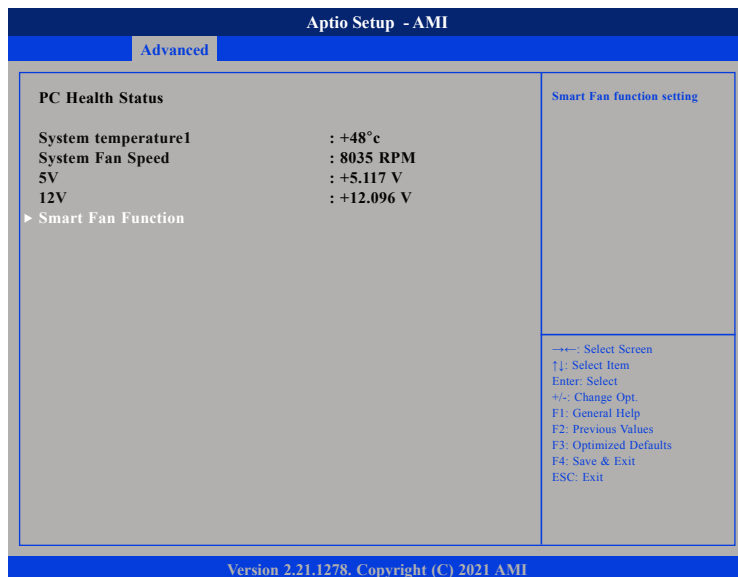

System temperature

Detects and displays current system temperature.

System Fan Speed

Detects and displays current system fan speed.

5V to 12V

Detects and displays the output voltages.

Smart Fan Function

Configures the smart fan function settings.

System Fan Setting

This section is used to configure system fan settings.

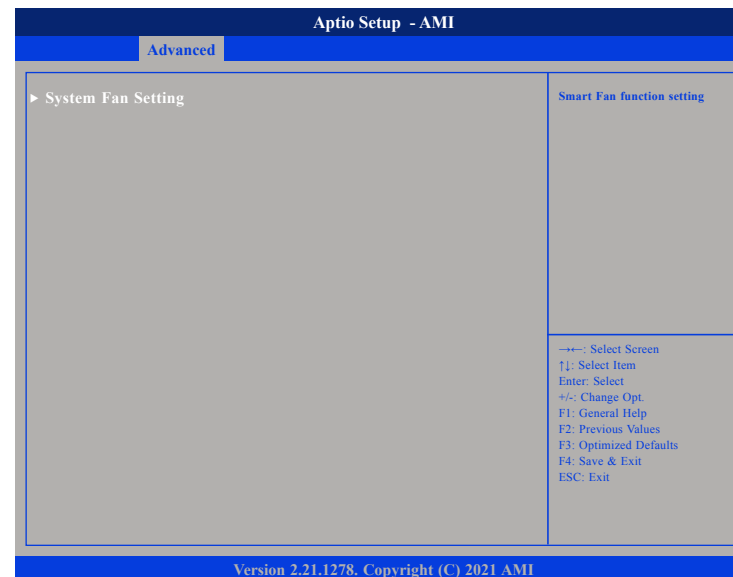

System Fan Setting

Configures smart fan function settings.

System Fan Setting

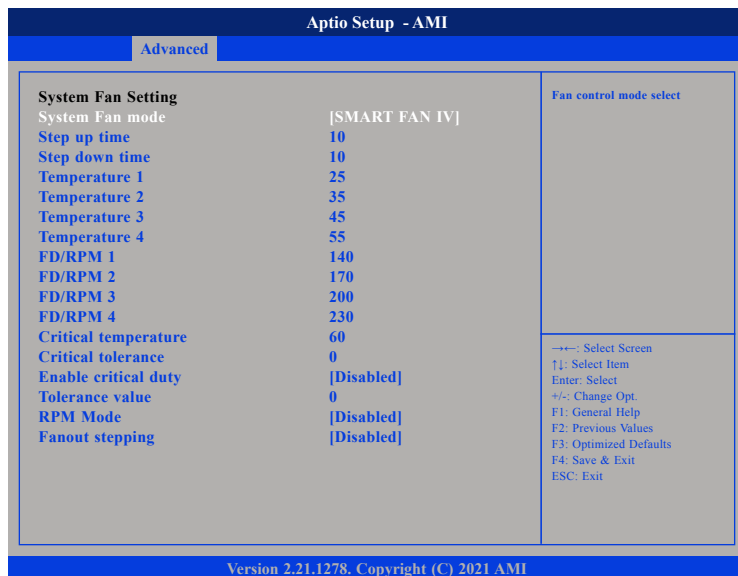

System Fan mode

Configures the fan mode. The options are Manual Mode, Thermal Cruise Mode (automatic fan mode), Speed Cruise Mode or Smart Fan IV Mode.

Step up time

The amount of time fan takes to increase its value by one step. (Units are intervals of 0.1 second)

Step down time

The amount of time fan takes to decrease its value by one step. (Units are intervals of 0.1 second)

Temperature 1 to Temperature 4

Configures the temperature setting.

FD/RPM 1 to FD/RPM 4

The value of Fan Duty/RPM when temperature is T1 to T4.

Critical temperature

Configures the time that Fan Out requires for reducing its value by one step.

Critical tolerance

Configures the tolerance of critical temperature.

Enable critical duty

Enables critical duty, if enabled, it will use critical duty value for fan out. If not will use full speed for fan out.

RPM Mode

Enables or disables Smart Fan IV close loop fan control RPM Mode.

Fanout stepping

Enables or disables Smart Fan IV stepping.

USB Configuration

This section is used to configure USB parameters.

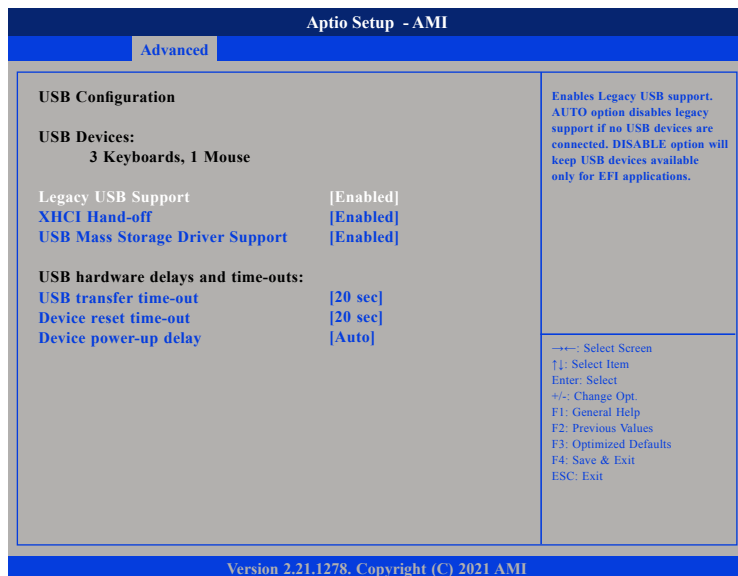

Legacy USB Support

Enables Legacy USB.

Auto Disables support for Legacy when no USB devices are connected.

Disable Keeps USB devices available only for EFI applications

XHCI Hand-off

This is a workaround for Oses without XHCI hand-off support. The XHCI ownership change should be claimed by XHCI driver.

USB Mass Storage Driver Support

Enables or disables USB Mass Storage Driver Support.

USB Transfer Time-out

The time-out value for control, bulk, and interrupt transfers.

Device Reset Time-Out

Selects the USB mass storage device start unit command time-out.

Device Power-up Delay

Maximum time the device will take before it properly reports itself to the Host Controller. 'Auto' uses default value: for a Root port it is 100ms, for a Hub port the delay is taken from Hub descriptor.

Network Stack

This section is used to configure the network stack.

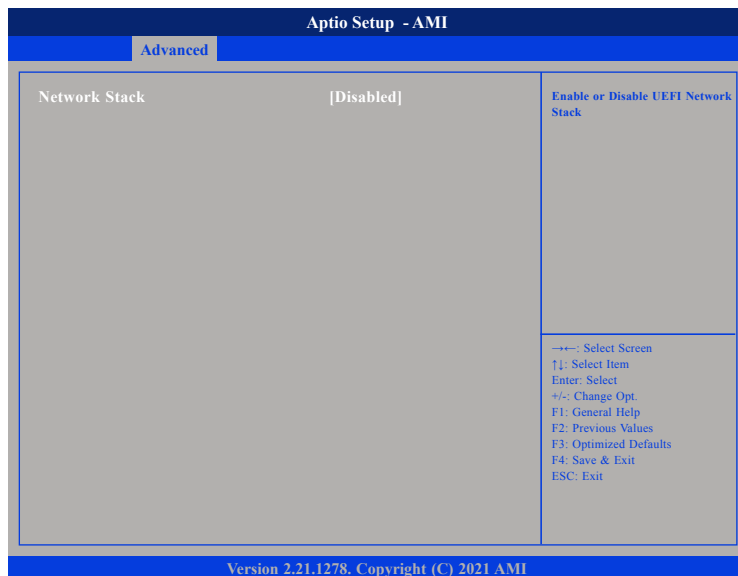

Network Stack

Enables or disables UEFI network stack.

SDIO Configuration

This section is used to configure the SDIO access mode.

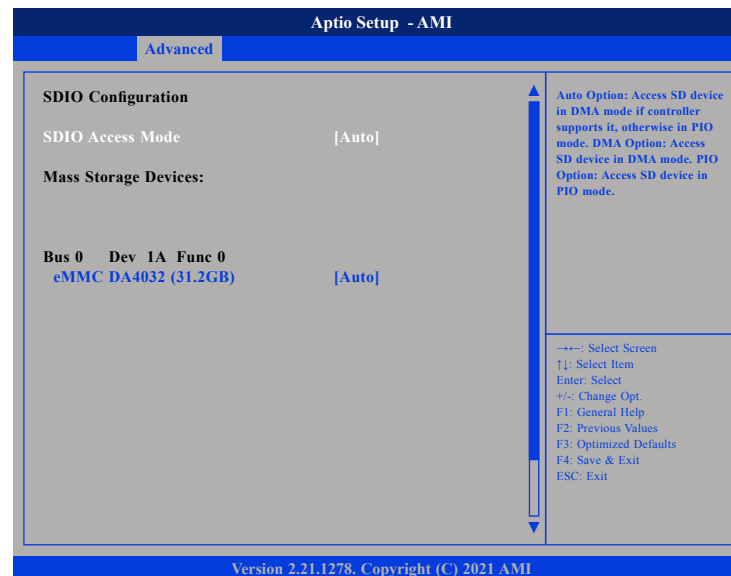

SDIO Access Mode

Auto option: Access SD device in DMA mode if controller supports it, otherwise in PIO mode.

DMA option: Access SD device in DMA mode.

PIO option: Access SD device in PIO mode.

eMMC DA4032 (31.2GB)

Mass storage device emulation type. 'Auto' enumerates devices less than 530MB as floppies. Forced FDD option can be used to force HDD formatted drive to boot as FDD.

Chipset

This section gives you functions to configure the system based on the specific features of the chipset. The chipset manages bus speeds and access to system memory resources.

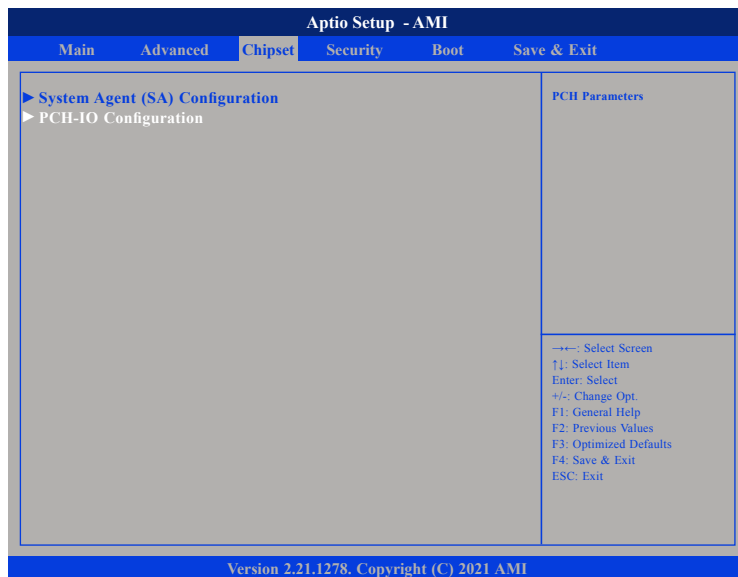

System Agent (SA) Configuration

System Agent (SA) parameters.

PCH-IO Configuration

PCH-IO parameters.

System Agent (SA) Configuration

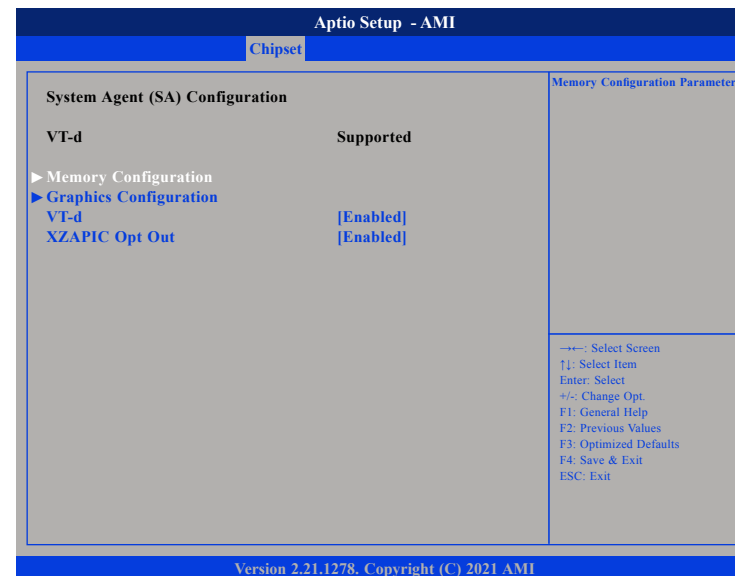

Memory Configuration

Configures the memory settings.

Graphics Configuration

Configures the graphics chip settings.

VT-d

Enables or disables the VT-d.

XZAPIC Opt Out

Enables or disables XZAPIC mode.

Memory Configuration

Aptio Setup - AMI	
Chipset	
Memory Configuration	
Memory RC Version	0.0.4.104
Memory Data Rate	3200 MTPS
Memory Timings (tCL-tRCD-tRP-tRAS)	22-22-22-52
Channel 0 Slot 0	Populated & Enabled
Size	4096 MB (Unknown)
Number of Ranks	1
Manufacturer	Kingston
Channel 0 Slot 1	Not Populated/Disab...
Channel 1 Slot 0	Populated & Enabled
Size	4096 MB (Unknown)
Number of Ranks	1
Manufacturer	Kingston
Channel 1 Slot 1	Not Populated / Disab...
Memory ratio/reference clock optio	
Safe Mode Support	[Disabled]
Maximum Memory Frequency	[Auto]
Safe Mode enable support. Option will be used for changes/WAS that may affect an stable MRC	
←→: Select Screen ↑↓: Select Item Enter: Select +/-: Change Opt. F1: General Help F2: Previous Values F3: Optimized Defaults F4: Save & Exit ESC: Exit	
Version 2.21.1278. Copyright (C) 2021 AMI	

Memory Configuration

Detects and displays information of the memory installed in the system.

Safe Mode Support

Safe Mode enables support.

Option will be used for changes/WAs that may affect an stable MRC.

Maximum Memory Frequency

Configures the maximum frequency of the memory.

Graphics Configuration

Aptio Setup - AMI	
Chipset	
Graphics Configuration	
Graphics Turbo IMON Current	31
Internal Graphics	[Auto]
GTT Size	[8MB]
Aperture Size	[256MB]
PSMI SUPPORT	[Disabled]
DVMT Pre-Allocated	[60M]
DVMT Total Gfx Mem	[256M]
DiSM Size	[0GB]
Graphics turbo IMON current values supported (14-31)	
←→: Select Screen ↑↓: Select Item Enter: Select +/-: Change Opt. F1: General Help F2: Previous Values F3: Optimized Defaults F4: Save & Exit ESC: Exit	
Version 2.21.1278. Copyright (C) 2021 AMI	

Graphics Turbo IMON Current

Configures the graphics turbo IMON value. The supported range is 14 to 31.

Internal Graphics

Keep IGFX enabled based on the setup options.

GTT Size

Configures the GTT memory size.

Aperture Size

Configures the Aperture size.

Note: above 4MB MMIO BIOS assignment is automatically enabled when selecting 2048MB aperture. To use this feature, please disable CSM Support.

PSMI Support

Enables or disables PSMI.

DVMT Pre-Allocated

Select DVMT 5.0 Pre-Allocated (fixed) graphics memory size used by the internal graphics device.

DVMT Total Gfx Mem

Configures the DVMT5.0 Total Graphic Memory size used by the IGD.

DiSM Size

Configures the DiSM Size for 2LM SKU.

PCH-IO Configuration

This section is used to configure PCH-IO configuration.

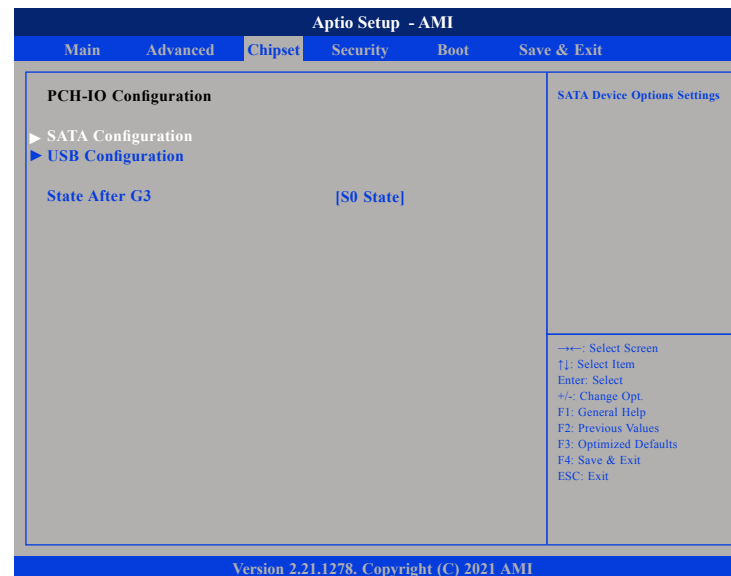

SATA Configuration

Configures SATA drives.

USB Configuration

Configures the USB.

State After G3

Configures the power state when power is re-applied after a power failure (G3 state).

SATA Configuration

This section is used to configure the SATA device option settings.

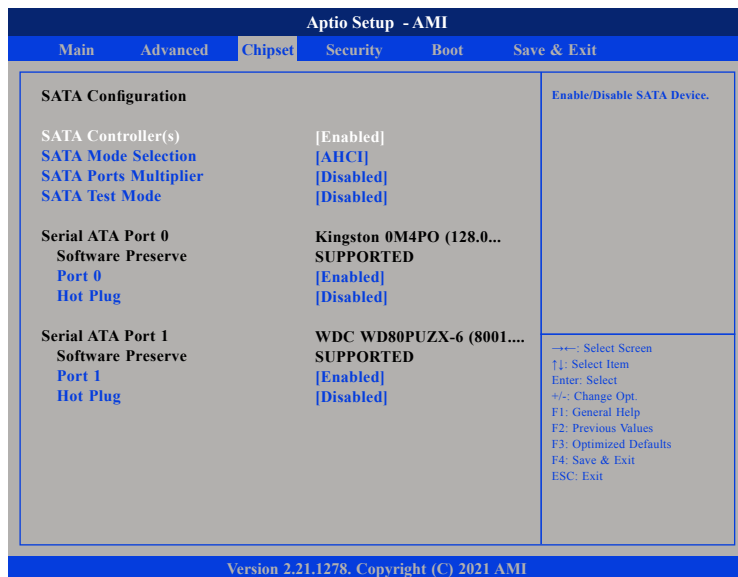

SATA Controller(s)

Enables or disables the SATA controller.

SATA Mode Selection

Configures the SATA as AHCI mode.

AHCI This option configures the Serial ATA drives to use AHCI (Advanced Host Controller Interface). AHCI allows the storage driver to enable the advanced Serial ATA features which will increase storage performance.

SATA Ports Multiplier

Enables or disables ports multiplier.

SATA Test Mode

Enables or disables test mode.

Port 0 to Port 1

Enables or disables SATA Port 0 to 1.

Hot Plug

Enables or disables hot plugging feature on SATA port 0 to port 1.

USB Configuration

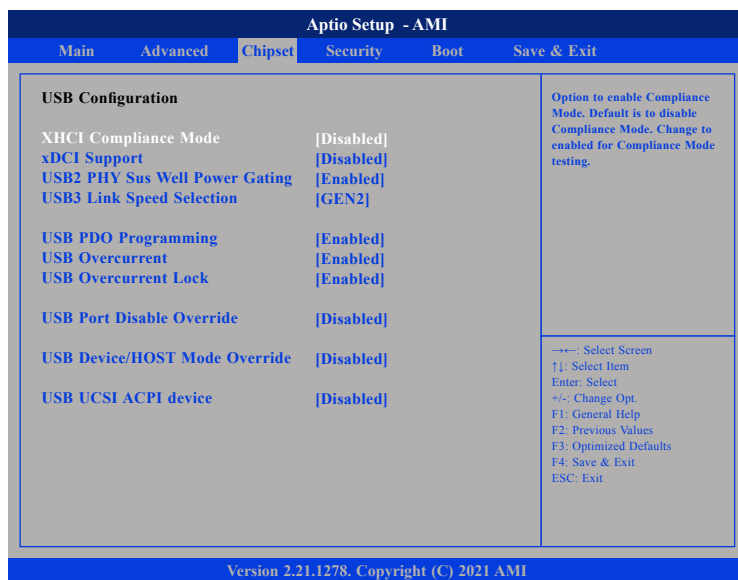

XHCI Compliance Mode

Option to enable compliance mode, default is to disable compliance mode.

xDCI Support

Enables or disables xDCI (USB OTG Device)

USB2 PHY Sus Well Power Gating

Select 'Enabled' to enable SUS Well PG for USB2 PHY. This option has no effect on PCH-H.

USB3 Link Speed Selection

This option is to select USB3 Link Speed Gen1 or Gen2.

USB PDO Programming

Select 'Enabled' if port disable override functionality is used.

USB Overcurrent

Select 'Disabled' for pin-based debug. If pin-based debug is enabled but USB overcurrent is not disabled, USB DbC does not work.

USB Overcurrent Lock

Select 'Enabled' if overcurrent functionality is used. Enabling this will make xHCI controller consume the overcurrent mapping data.

USB Port Disable Override

Selectively enable or disable the corresponding USB port from reporting a device connection to the controller.

USB Device/HOST Mode Override

Selectively enable or disable the corresponding USB 2.0 and USB 3.0 port device mode.

USB UCSI ACPI device

Enables or disables USB UCSI ACPI device

PCH-IO Configuration

This section is used to configure PCH-IO configuration.

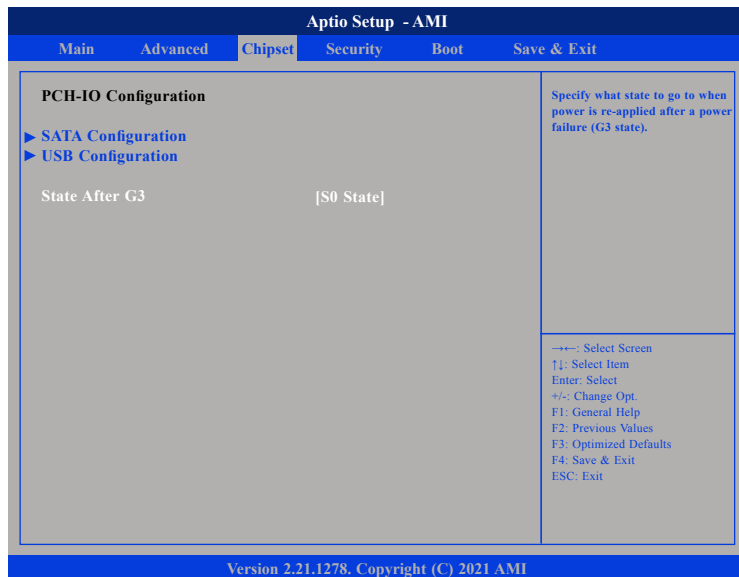

State after G3

Specify what state to go to when power is re-applied after a power failure.

Security

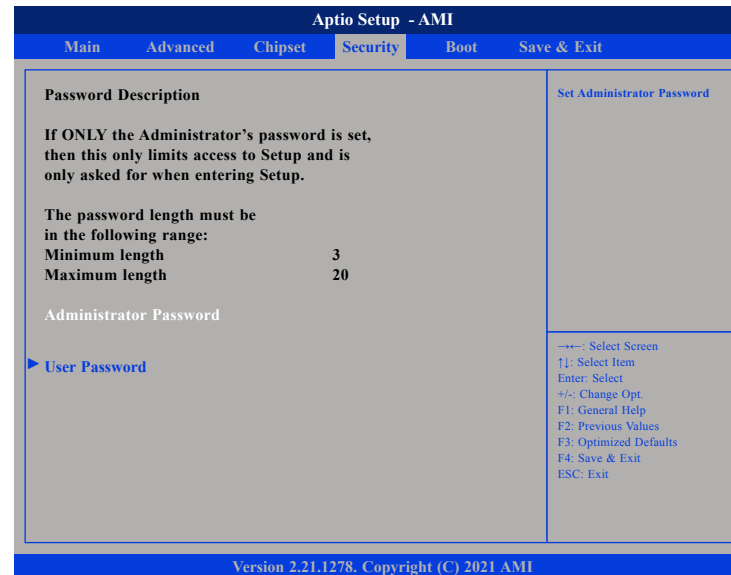

Administrator Password

Select this to reconfigure the administrator's password.

User Password

Select this to reconfigure the user's password.

Secure Boot

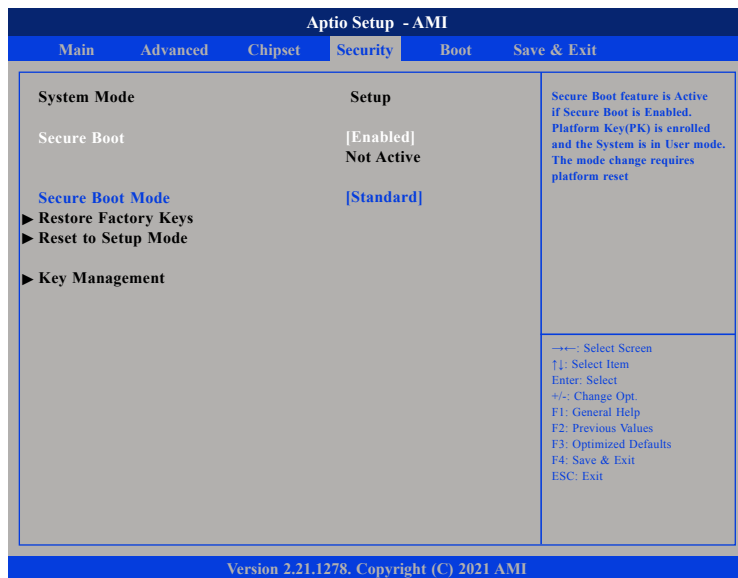

Secure Boot

Select this to enable or disable Secure Boot. Secure Boot only works when the system runs in user mode.

Secure Boot Mode

Select this to configure the Secure Boot mode.

Standard	Fixed secure boot policy.
Custom	Secure boot policy variables can be configured by a physically present user without full authentication.

Boot

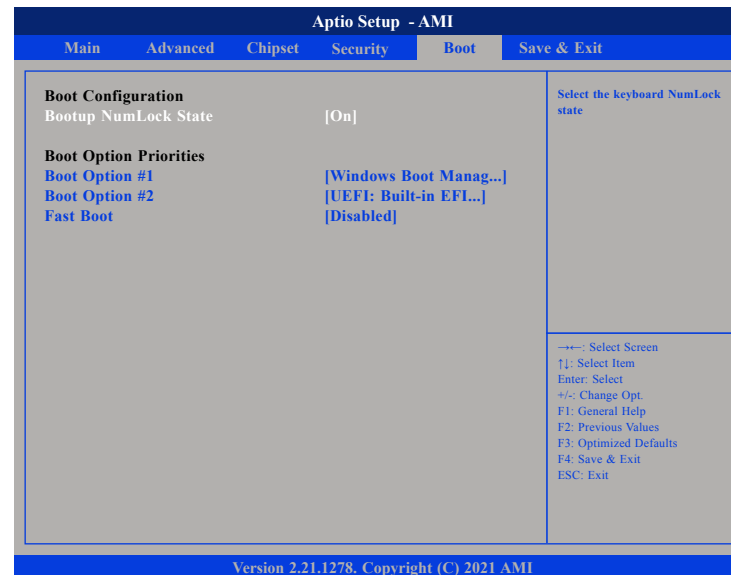

Bootup NumLock State

This allows you to determine the default state of the numeric keypad. By default, the system boots up with NumLock on wherein the function of the numeric keypad is the number keys. When set to Off, the function of the numeric keypad is the arrow keys.

Boot Option Priorities

Adjust the boot sequence of the system. Boot Option #1 is the first boot device that the system will boot from, next will be #2 and so forth.

Fast Boot

When enabled, the BIOS will shorten or skip some check items during POST. This will decrease the time needed to boot the system.

Save & Exit

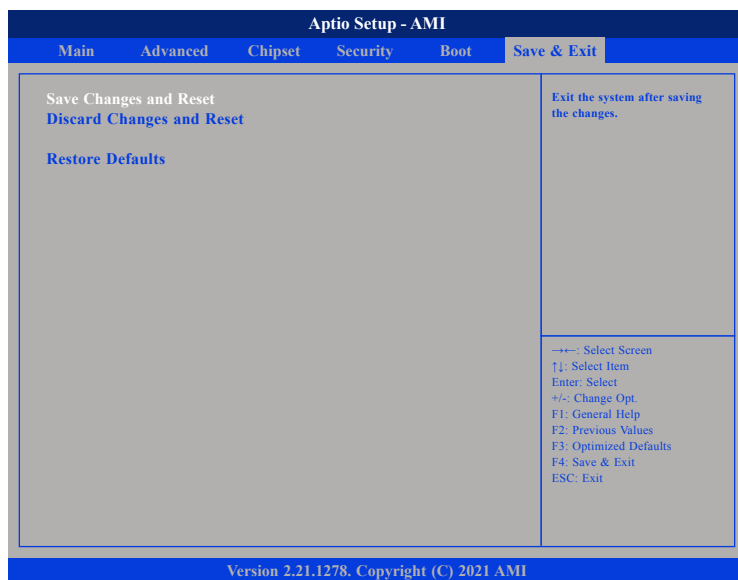

Save Changes and Reset

To save the changes and restart the system, select this field then press <Enter>. A dialog box will appear. Confirm by selecting Yes. You can also press <F4> to save and exit Setup.

Discard Changes and Reset

To exit the Setup utility without saving the changes and restart the system, select this field then press <Enter>. You may be prompted to confirm again before exiting.

Restore Defaults

To restore the BIOS to default settings, select this field then press <Enter>. A dialog box will appear. Confirm by selecting Yes.