

iTXL-H42EA (MH42EAT-SI)

Thin Mini-ITX Motherboard

User's Manual 1st Ed

Copyright Notice

This document is copyrighted, 2022. All rights are reserved. The original manufacturer reserves the right to make improvements to the products described in this manual at any time without notice.

No part of this manual may be reproduced, copied, translated, or transmitted in any form or by any means without the prior written permission of the original manufacturer. Information provided in this manual is intended to be accurate and reliable. However, the original manufacturer assumes no responsibility for its use, or for any infringements upon the rights of third parties that may result from its use.

The material in this document is for product information only and is subject to change without notice. While reasonable efforts have been made in the preparation of this document to assure its accuracy, GIGAIPC assumes no liabilities resulting from errors or omissions in this document, or from the use of the information contained herein.

GIGAIPC reserves the right to make changes in the product design without notice to its users.

Acknowledgement

All other products' name or trademarks are properties of their respective owners.

- Microsoft Windows is a registered trademark of Microsoft Corp.
- Intel, Pentium, Celeron, and Xeon are registered trademarks of Intel Corporation
- Core, Atom are trademarks of Intel Corporation
- ITE is a trademark of Integrated Technology Express, Inc.
- IBM, PC/AT, PS/2, and VGA are trademarks of International Business Machines Corporation.

All other product names or trademarks are properties of their respective owners.

Packing List

Before setting up your product, please make sure the following items have been shipped:

Item	Quantity
iTXL-H42EA MB	1
SATA power cable	2
Standard I/O Shield	1
Low-Profile I/O Shield	1

If any of these items are missing or damaged, please contact your distributor or sales representative immediately.

About this Document

This User's Manual contains all the essential information, such as detailed descriptions and explanations on the product's hardware and software features (if any), its specifications, dimensions, jumper/connector settings/definitions, and driver installation instructions (if any), to facilitate users in setting up their product.

Users may refer to the GIGAIPC.com for the latest version of this document.

Safety Precautions

Please read the following safety instructions carefully. It is advised that you keep this manual for future references

1. All cautions and warnings on the device should be noted.
2. Make sure the power source matches the power rating of the device.
3. Position the power cord so that people cannot step on it. Do not place anything over the power cord.
4. Always completely disconnect the power before working on the system's hardware.
5. No connections should be made when the system is powered as a sudden rush of power may damage sensitive electronic components.
6. If the device is not to be used for a long time, disconnect it from the power supply to avoid damage by transient over-voltage.
7. Always disconnect this device from any AC supply before cleaning.
8. While cleaning, use a damp cloth instead of liquid or spray detergents.
9. Make sure the device is installed near a power outlet and is easily accessible.
10. Keep this device away from humidity.
11. Place the device on a solid surface during installation to prevent falls
12. Do not cover the openings on the device to ensure optimal heat dissipation.

13. Watch out for high temperatures when the system is running.
14. Do not touch the heat sink or heat spreader when the system is running
15. Never pour any liquid into the openings. This could cause fire or electric shock.
16. As most electronic components are sensitive to static electrical charge, be sure to ground yourself to prevent static charge when installing the internal components. Use a grounding wrist strap and contain all electronic components in any static-shielded containers.
17. If any of the following situations arises, please the contact our service personnel:
 - i. Damaged power cord or plug
 - ii. Liquid intrusion to the device
 - iii. Exposure to moisture
 - iv. Device is not working as expected or in a manner as described in this manual
 - v. The device is dropped or damaged
 - vi. Any obvious signs of damage displayed on the device
- 18. DO NOT LEAVE THIS DEVICE IN AN UNCONTROLLED ENVIRONMENT WITH TEMPERATURES BEYOND THE DEVICE'S PERMITTED STORAGE TEMPERATURES (SEE CHAPTER 1) TO PREVENT DAMAGE.**

FCC Statement

Warning!



This device complies with Part 15 FCC Rules. Operation is subject to the following two conditions: (1) this device may not cause harmful interference, and (2) this device must accept any interference received including interference that may cause undesired operation.

Caution:

There is a danger of explosion if the battery is incorrectly replaced. Replace only with the same or equivalent type recommended by the manufacturer. Dispose of used batteries according to the manufacturer's instructions and your local government's recycling or disposal directives.

Attention:

Il y a un risque d'explosion si la batterie est remplacée de façon incorrecte. Ne la remplacer qu'avec le même modèle ou équivalent recommandé par le constructeur. Recycler les batteries usées en accord avec les instructions du fabricant et les directives gouvernementales de recyclage.

China RoHS Requirements (CN)

产品中有毒有害物质或元素名称及含量

GIGAIPC Main Board/ Daughter Board/ Backplane

部件名称	有毒有害物质或元素					
	铅 (Pb)	汞 (Hg)	镉 (Cd)	六价铬 (Cr(VI))	多溴联苯 (PBB)	多溴二苯醚 (PBDE)
印刷电路板 及其电 子组件	○	○	○	○	○	○
外部信号 连接器 及线材	○	○	○	○	○	○

○: 表示该有毒有害物质在该部件所有均质材料中的含量均在 SJ/T 11363-2006 标准规定的限量要求以下。
 X: 表示该有毒有害物质至少在该部件的某一均质材料中的含量超出 SJ/T 11363-2006 标准规定的限量要求。
 备注: 此产品所标示之环保使用期限, 系指在一般正常使用状况下。

China RoHS Requirement (EN)

Poisonous or Hazardous Substances or Elements in Products GIGAIPC Main Board/ Daughter Board/ Backplane

Component	Poisonous or Hazardous Substances or Elements					
	Lead (Pb)	Mercury (Hg)	Cadmium (Cd)	Hexavalent Chromium (Cr(VI))	Polybrominated Biphenyls (PBB)	Polybrominated Diphenyl Ethers (PBDE)
PCB & Other Components	○	○	○	○	○	○
Wires & Connectors for External Connections	○	○	○	○	○	○

○ : The quantity of poisonous or hazardous substances or elements found in each of the component's parts is below the SJ/T 11363-2006-stipulated requirement.
 X: The quantity of poisonous or hazardous substances or elements found in at least one of the component's parts is beyond the SJ/T 11363-2006-stipulated requirement.
 Note: The Environment Friendly Use Period as labeled on this product is applicable under normal usage only

Table Contents

Thin Mini-ITX Motherboard User's Manual 1st Ed	1
Copyright Notice	2
Acknowledgement	3
Packing List.....	4
About this Document	5
Safety Precautions	6
FCC Statement.....	8
China RoHS Requirements (CN).....	9
China RoHS Requirement (EN)	10
Chapter 1 - Product Specifications	14
1.1 Specifications	16
Chapter 2 – Hardware Information	18
2.1 Jumpers and Connectors	19
2.2.1 IO Connector Information.....	23
2.2.2 DC_IN (DC In Jack).....	24
2.2.3 DC_IN2 (ATX 2x2 Pin Power Connector).....	25
2.2.4 USB31_1, USB31_2 (USB 3.2 Gen 1 Type A connector x 4)	26
2.2.5 LAN1, LAN2 (GbE Ethernet LAN Ports x 2).....	27
2.2.6 HDMI_DP (HDMI + DP connector)	28
2.2.7 SATA0, 1, 2, 3 (SATA 6Gb/s Connector x 4).....	29
2.2.8 Battery (Battery Connector)	30

2.2.9	FP_AUDIO (Front Panel Audio Header)	31
2.2.10	SPKR (Speaker Out Connector)	32
2.2.11	M2E (M.2 Slot, 2230 E-Key)	33
2.2.12	PCIEX8 (PCIe Gen3 x8)	34
2.2.13	CPU_FAN (CPU FAN Connector)	35
2.2.14	FUSB2_2 (USB 2.0 Header)	36
2.2.15	FUSB2_1 (USB 2.0 Header).....	37
2.2.16	SYS_FAN (System Fan Connector)	38
2.2.17	LSW (LVDS Resolution Jumper)	39
2.2.18	EDP (Embedded Display Port connector)	40
2.2.19	BKL_CN (Backlight Control Connector)	41
2.2.20	LVDS (LVDS Connector)	42
2.2.21	SYS_PANEL (System Panel Header).....	43
2.2.22	GPIO_CNT (General purpose input/output Connector)	44
2.2.23	COM1 (COM header RS-232/422/485 & RI/5V/12V)	45
2.2.24	JCOM1 (RI# pin RI#/5V/12V Select for COM1 Port)	46
2.2.25	AT_CN (AT/ATX mode select jumper).....	47
2.2.26	COM2 (COM header (RS-232))	48
2.2.27	FUSB2_3 (USB 2.0 Header)	49
2.2.28	ATX_CTL (ATX Control Header, Support PS-ON Signal of Power Supply Unit)	50
2.2.29	SATA_PWR1, SATA_PWR2 (SATA Power Connector x2)	51
2.2.30	CLR_CMOS (Clear CMOS Jumper).....	52
2.2.31	ME_EN (ME Enable Jumper)	53

2.2.32	SODIMM1, SODIMM2 (2 x DDR4 SO-DIMM Sockets) ...	54
2.2.33	M2_M (M.2 Slot, 2280 M-Key)	55

Chapter 3 – BIOS **56**

3.1	Introduction	57
3.2	The Main Menu.....	58
3.3	Advanced	59
3.3.1	TPM Configuration.....	60
3.3.2	IT8786 Super IO Configuration	62
3.3.3	Hardware Monitor	63
3.3.4	S5 RTC Wake Settings	64
3.3.5	CPU Configuration	65
3.3.6	SATA And RST Configuration.....	66
3.3.7	AMI Graphic Output Protocol Policy.....	67
3.3.8	Network Stack Configuration.....	68
3.3.9	NVMe Configuration.....	69
3.3.10	Offboard SATA Controller Configuration	70
3.3.11	Digital IO Port Configuration	71
3.4	Chipset	72
3.5	Security	74
3.6	Boot.....	77
3.7	Save & Exit	78

Chapter 1

Chapter 1 - Product Specifications

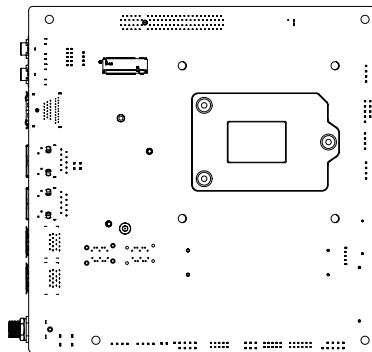
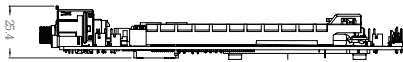
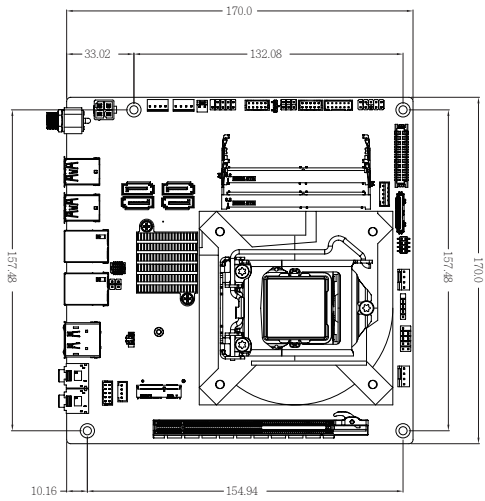
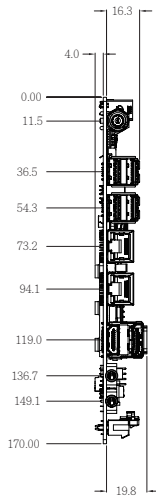

1.1 Specifications

Motherboard	iTXL-H42EA (MH42EAT-SI)
Form Factor	Thin Mini-ITX 170W x 170D (mm)
CPU	Support for 10th Generation Intel® Core™ i9/i7/i5/i3 processors, Pentium® & Celeron® processors in the LGA1200 package TDP under 65W L3 cache varies with CPU
Socket	1 x LGA 1200
Chipset	Intel® H420E Express Chipset
Memory	2 x DDR4 SO-DIMM sockets, Max. Capacity 64GB Support Dual channel DDR4 2933/2666/2400 MHz memory modules
Ethernet	2 x GbE LAN Ports (Intel® I219V & Intel® I211AT)
Video	Integrated Graphics Processor - Intel® HD Graphics support: 1 x HDMI 2.0 port, supporting a maximum resolution of 4096x2160 @60Hz 1 x DP port, supporting a maximum resolution of 4096x2160 @60Hz 1 x LVDS port, supporting a maximum resolution of 1920x1080 @60Hz 1 x eDP port, supporting a maximum resolution of 4096x2160 @60Hz * eDP connector is alternative with LVDS port, only one can be worked at the same time (2 independent display outputs)
Audio	Realtek® ALC897
Storage	4 x SATA 6Gb/s Ports
Raid	—
Expansion Slots	1 x PCIe x16 (Gen3 x8) 1 x 2280 M.2 M-Key (PCIe x2) 1 x 2230 M.2 E-Key

Motherboard	iTXL-H42EA (MH42EAT-SI)
Internal I/O	1 x 4-pin ATX main power connector 2 x SATA Power connectors 1 x CPU fan header 1 x System fan header 1 x Front panel header 1 x Front panel audio header 1 x 2W Speaker out header 5 x USB 2.0 headers 1 x COM header (RS-232) 1 x COM header (RS-232/422/485 & RI/5V/12V) 1 x GPIO (8 bits) & SMBus header 1 x Clear CMOS header 1 x Backlight Control header 1 x ATX Control header 1 x AT/ATX mode select jumper
Rear I/O	2 x Audio Jacks (Line out, Mic in) 1 x HDMI 1 x Display Port 2 x RJ45 LAN Ports 4 x USB 3.2 Gen 1 1 x DC Jack (+12V/+19V~24VDC)
TPM	1 x TPM header
OS Compatibility	Windows® 10 (x64)
Operating Properties	Operating temperature: 0°C to 60°C Operating humidity: 0-90% (non-condensing) Non-operating temperature: -40°C to 85°C Non-operating humidity: 0%-95% (non-condensing)
Order Information	Motherboard: 9MH42EATMR-SI
Optional kit:	TPM 2.0 module : 9CTM000NR-00 TPM Cable : 25CRZ-100600-S9R

Chapter 2

Chapter 2 – Hardware Information

2.1 Jumpers and Connectors

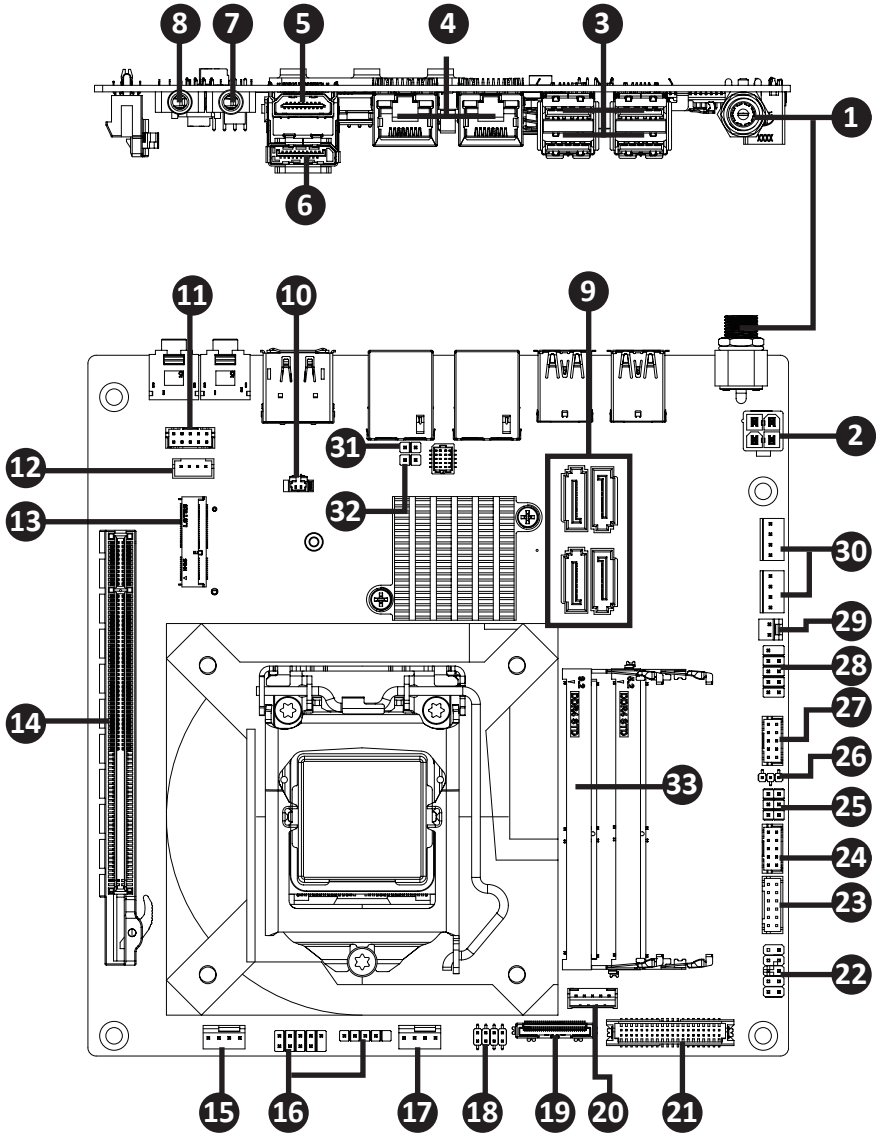

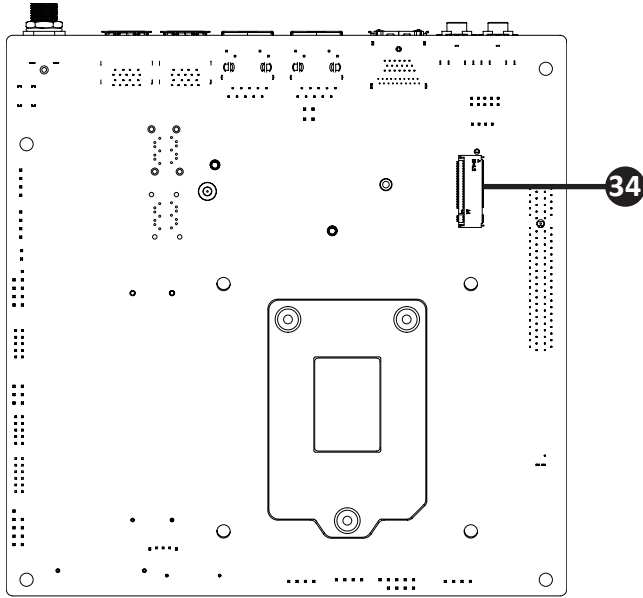

No	Code	Description
1	DC_IN	DC In Jack
2	DC_IN2	ATX 2x2 Pin Power Connector
3	USB31_1, USB31_2,	USB 3.2 Gen 1 Type A Connector x 4
4	LAN1, LAN2	GbE Ethernet LAN ports x 2
5	HDMI_DP	HDMI Connector
6		Display Port Connector
7	LINE_OUT	Line Out port (Green)
8	MIC_IN	Mic In port (Pink)

No	Code	Description
9	SATA0, 1, 2, 3	SATA 6Gb/s Connector x 4
10	Battery	Battery Connector
11	FP_AUDIO	Front Panel Audio Header
12	SPKR	Speaker out Connector
13	M2E	M.2 Slot, 2230 E-Key
14	PCIEX8	PCIe Gen3 x8
15	CPU_FAN	CPU FAN Connector
16	FUSB2_1	USB 2.0 Header
16	FUSB2_2	USB 2.0 Header
17	SYS_FAN	System Fan Connector
18	LSW	LVDS Resolution Jumper
19	EDP	Embedded Display Port connector
20	BKL_CN	Backlight Control Connector
21	LVDS	LVDS Connector
22	SYS_PANEL	System Panel Header
23	GPIO_CNT	General purpose input/out Connector
24	COM1	COM header (RS-232/422/485 & RI/5V/12V)
25	JCOM1	RI# pin RI#/5V/12V Select for COM1 port
26	AT_CN	AT/ATX mode select jumper
27	COM2	COM header (RS-232)
28	FUSB2_3	USB 2.0 Header
29	ATX_CTL	ATX Control Header, Support PS-ON Signal of Power Supply Unit

No	Code	Description
30	SATA_PWR1 SATA_PWR2	SATA Power Connector x 2
31	CLR_CMOS	Clear CMOS Jumper
32	ME_EN	ME Enable jumper
33	SODIMM1, SODIMM2	2 x DDR4 SO-DIMM Sockets
34	M2_M	M.2 Slot, 2280 M-Key

2.2.1 IO Connector Information

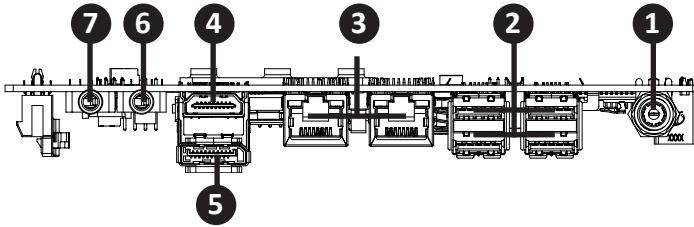

	Code	Description
1	DC_IN	DC In Jack
2	USB31_1, USB31_2,	USB 3.2 Gen 1 Type A Connector x 4
3	LAN1, LAN2	GbE Ethernet LAN Port x 2
4	HDMI_DP	HDMI Connector
5		Display Port Connector
6	LINE_OUT	Line Out port (Green)
7	MIC_IN	Mic In port (Pink)

2.2.2 DC_IN (DC In Jack)

1

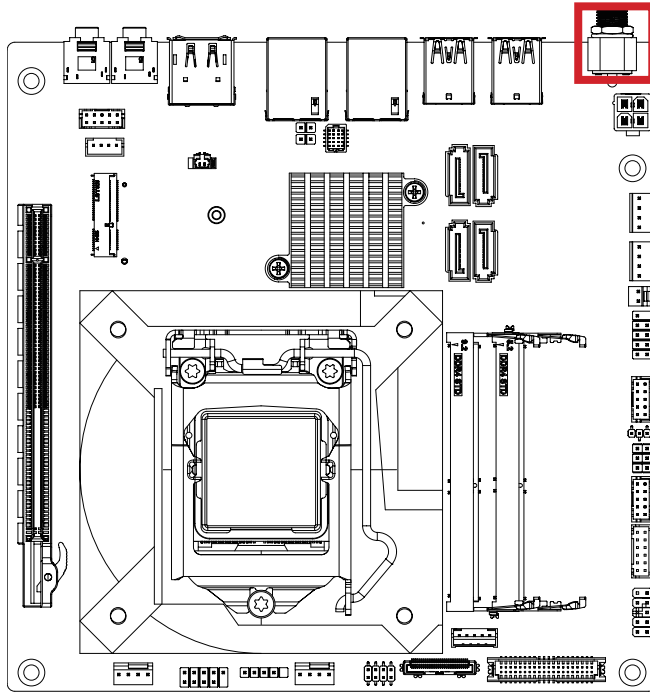

DC In Jack Connector



Connector PN

655-360-000

Vendor

SHEN-MING

2.2.3 DC_IN2 (ATX 2x2 Pin Power Connector)

2

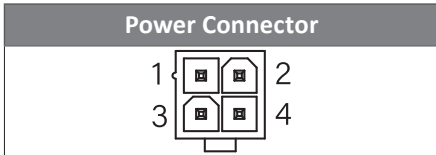
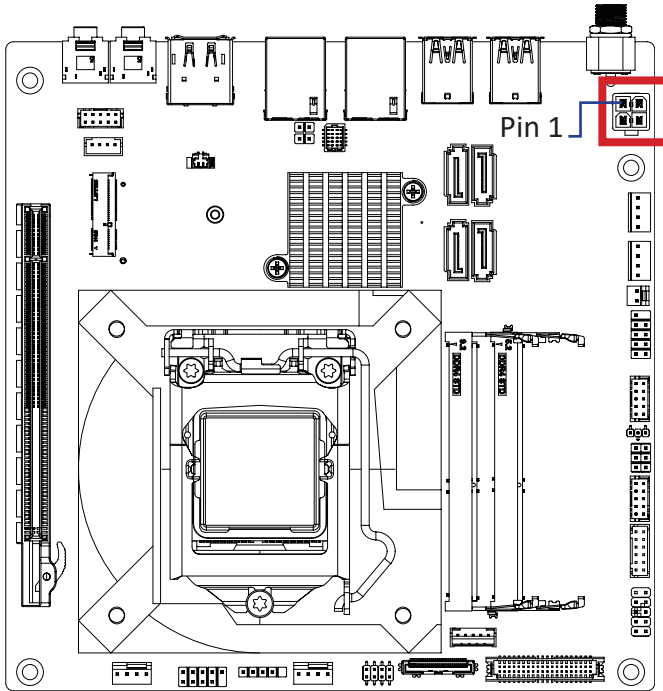

Connector PN	Vendor
740-81-04TW56	PINREX

Pin No.	Definition
1	GND
2	GND
3	DC IN
4	DC IN

2.2.4 USB31_1, USB31_2 (USB 3.2 Gen 1 Type A connector x 4)

3

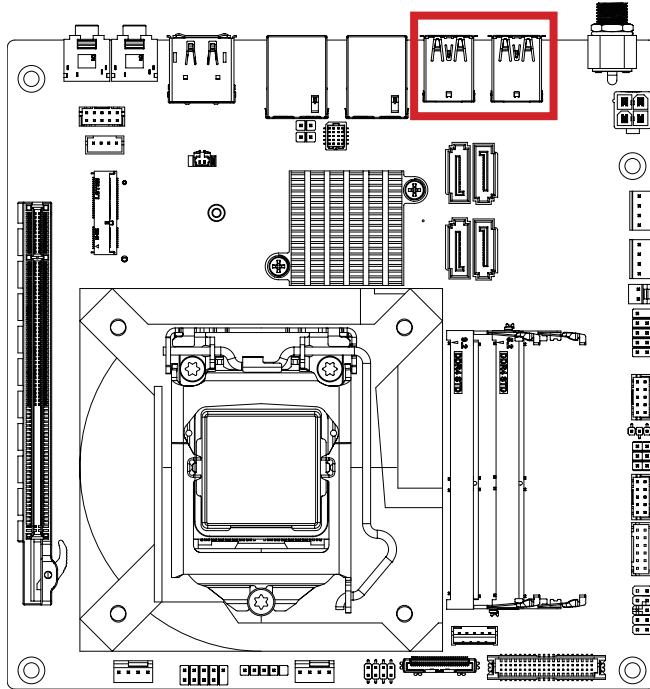

USB Connector



Connector PN

UEA11121-8FS6-4F

Vendor

FOXCONN

ABA-USB-079-K01

LOTES

Pin No.	Definition	Pin No.	Definition
1	5V	10	5V
2	D1n	11	D0n
3	D1p	12	D0p
4	GND	13	GND
5	USB3_RX1n	14	USB3_RX2n
6	USB3_RX1p	15	USB3_RX2p
7	GND	16	GND
8	USB3_TX1n	17	USB3_TX2n
9	USB3_TX1p	18	USB3_TX2p

2.2.5 LAN1, LAN2 (GbE Ethernet LAN Ports x 2)

4

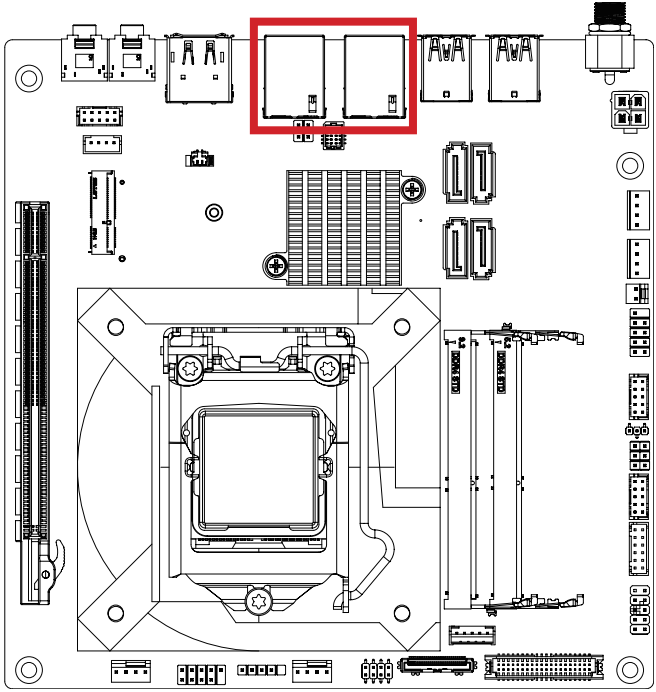

LAN Connector

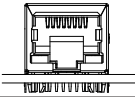

Pin No.	Definition	Pin No.	Definition
1	TX1+	4	TX3+
2	TX1-	5	TX3-
3	TX2+	7	TX4+
6	TX2-	8	TX4-

State	Description
Orange On	1Gbps data rate
Green On	100Mbps data rate
Off	10Mbps data rate

Connector PN	Vendor
RB1-13NB5N5A	UDE

2.2.6 HDMI_DP (HDMI + DP connector)

5 6

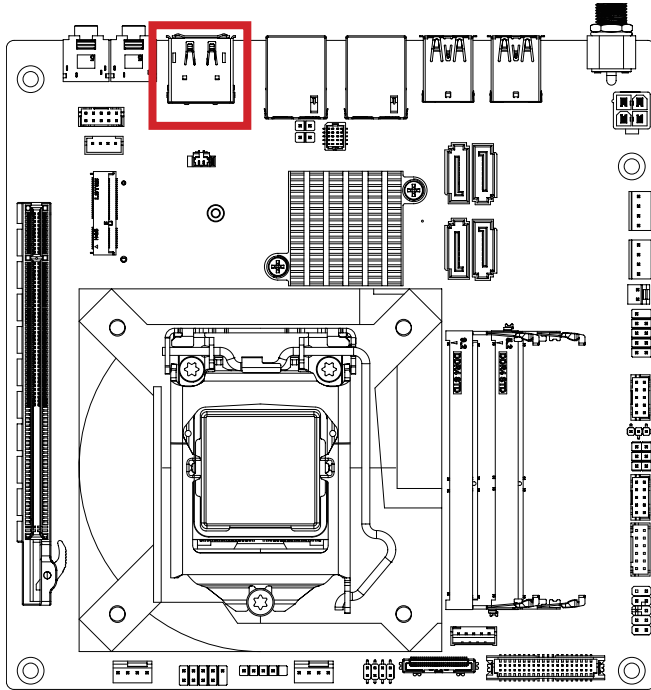

HDMI + DP Connector



HDMI Connector			
Pin No.	Definition	Pin No.	Definition
1	TX2p	11	GND
2	GND	12	CLKn
3	TX2n	13	NC
4	TX1p	14	NC
5	GND	15	SCL
6	TX1n	16	SDA
7	TX0p	17	GND
8	GND	18	5V
9	TX0n	19	Hot Plug Detect
10	CLKp		

DP Connector			
Pin No.	Definition	Pin No.	Definition
1	TX0p	11	GND
2	GND	12	TX3n
3	TX0n	13	GND
4	TX1p	14	GND
5	GND	15	AUXp
6	TX1n	16	GND
7	TX2p	17	AUXn
8	GND	18	Hot Plug Detect
9	TX2n	19	3.3V
10	TX3p	20	3.3V

2.2.7 SATA0, 1, 2, 3 (SATA 6Gb/s Connector x 4)

9

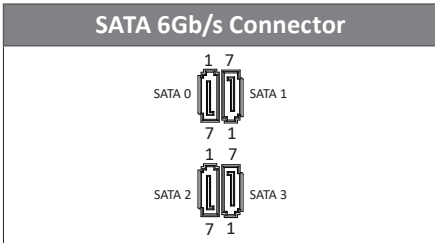
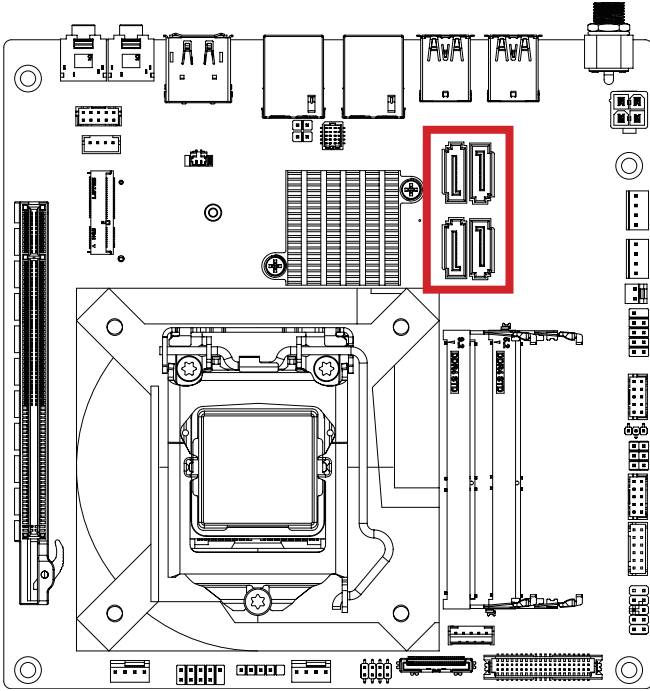

Connector PN	Vendor
WATM-07ABNB2BAUW3	WINWIN
770-83-07SW19	PINREX

Pin No.	Definition
1	GND
2	TXp
3	TXn
4	GND
5	RXn
6	RXp
7	GND

2.2.8 Battery (Battery Connector)

10

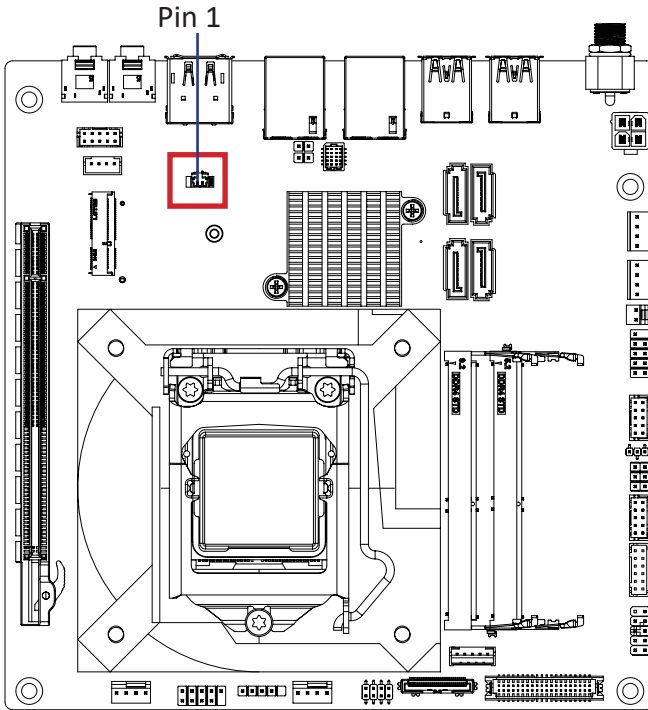

Battery Connector

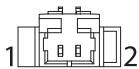

Pin No.	Definition
1	3V
2	GND

2.2.9 FP_AUDIO (Front Panel Audio Header)

11

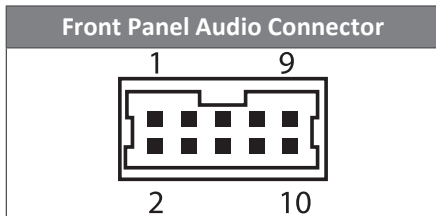
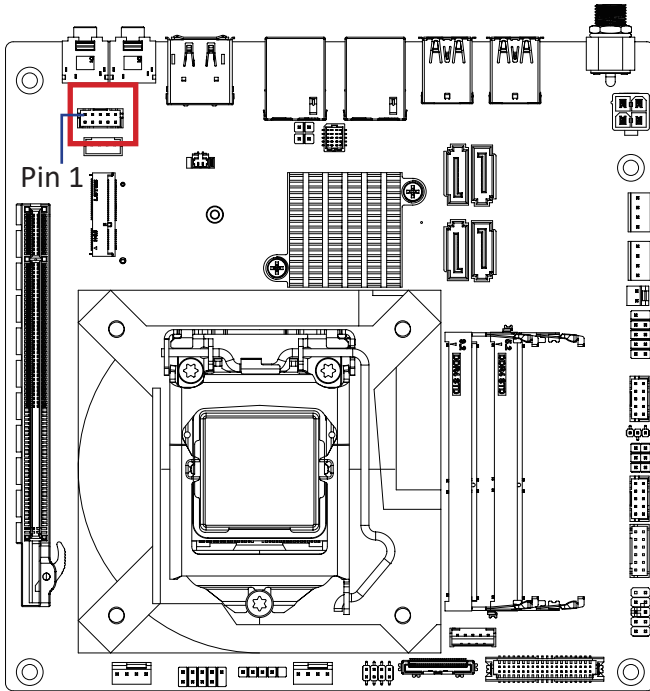

Connector PN	Vendor
725-81-10TW00	PINREX
A2004WV-2X05P46	JOINT-TECH

Pin No.	Definition	Pin No.	Definition
1	MIC-LEFT	6	GND
2	GND	7	JACKSENCE DELTECT
3	MIC-RIGHT	8	NC
4	DELTECT	9	LINE-LEFT
5	LINE-RIGHT	10	GND

2.2.10 SPKR (Speaker Out Connector)

12

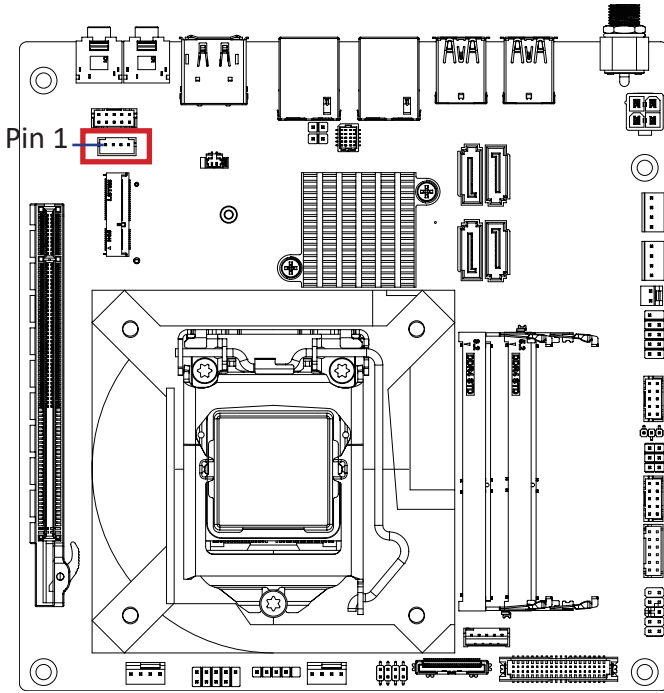

Speaker Out Connector

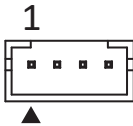

Pin No.	Definition
1	SPEAKER L+
2	SPEAKER L-
3	SPEAKER R-
4	SPEAKER R+

Connector PN

Vendor

721-81-045W00

PINREX

A2001WV-04P146

JOINT-TECH

2.2.11 M2E (M.2 Slot, 2230 E-Key)

13

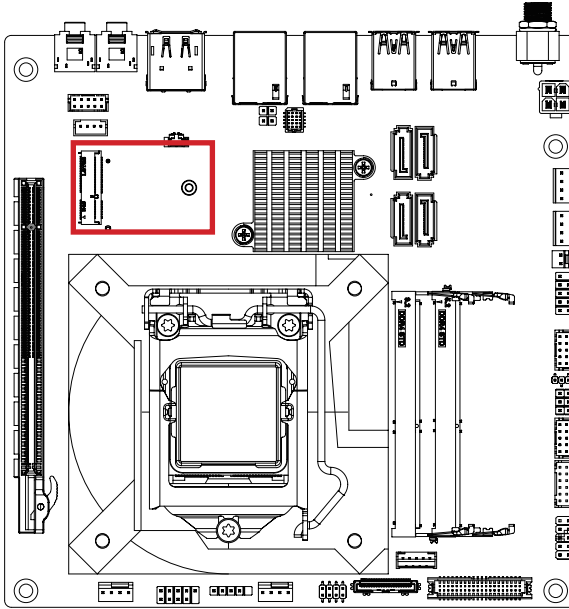

M.2 E Key Connector

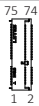

Pin No.	Definition	Pin No.	Definition
1	GND	2	3.3V
3	D1p	4	3.3V
5	D1n	6	NC
7	GND	8	NC
9	NC	10	NC
11	NC	12	NC
13	GND	14	NC
15	NC	16	NC
17	NC	18	GND
19	GND	20	NC
21	NC	22	NC
23	NC		

Pin No.	Definition	Pin No.	Definition
33	GND	32	NC
35	PCIE_TXp	34	NC
37	PCIE_TXn	36	NC

39	GND	38	CL_Reset
41	PCIE_RXp	40	CL_DATA
43	PCIE_RXn	42	CL_Clock
45	GND	44	NC
47	PCIE CLOCKp	46	NC
49	PCIE CLOCKn	48	NC
51	GND	50	SUSCLK
53	PCIE Clock Request	52	PCIRST
55	PCIE wake up	54	BT_Disable
57	GND	56	WLAN_DISABLE
59	NC	58	NC
61	NC	60	NC
63	GND	62	NC
65	NC	64	NC
67	NC	66	NC
69	GND	68	NC
71	NC	70	NC
73	NC	72	3.3V
75	GND	74	3.3V

Connector PN	Vendor
80152-8521	BELLWETHER
2E0BC21-S85BE-7H	FOXCONN

2.2.12 PCIEX8 (PCIe Gen3 x8)

14

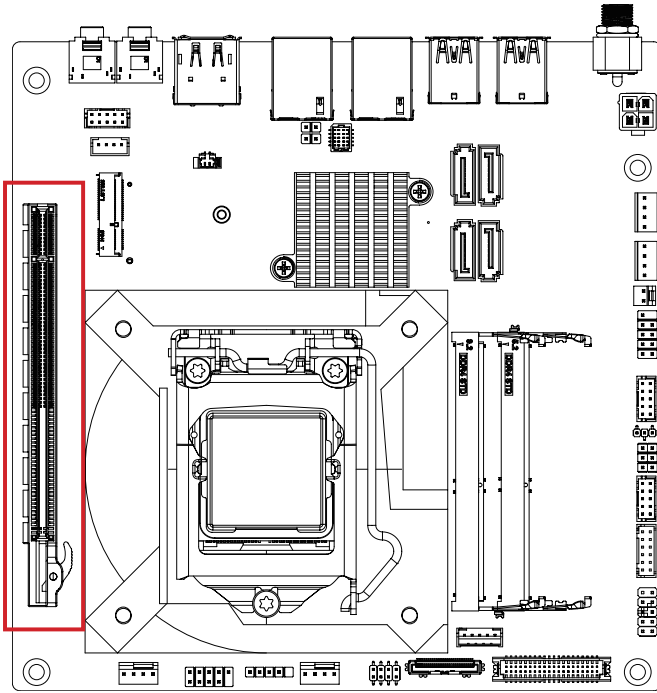

PCIEX16 connector

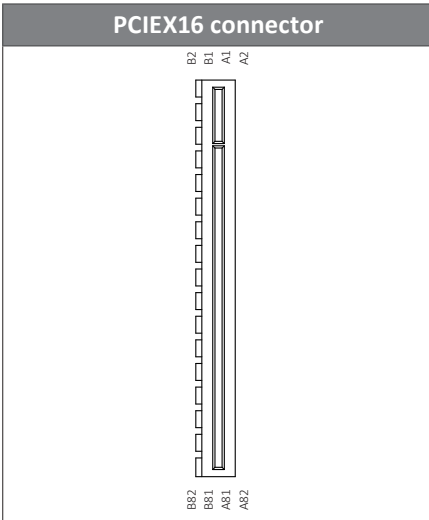

2.2.13 CPU_FAN (CPU FAN Connector)

15

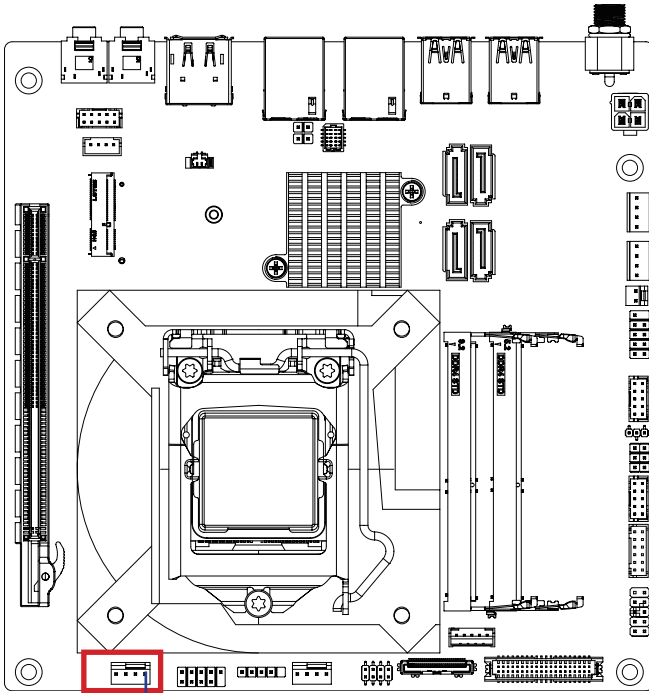

Pin 1

CPU Fan Connector	
4	1

Connector PN	Vendor
744-81-045W11	PINREX

Pin No.	Definition
1	GND
2	12V
3	Detect
4	Speed Control

2.2.14 FUSB2_2 (USB 2.0 Header)

16

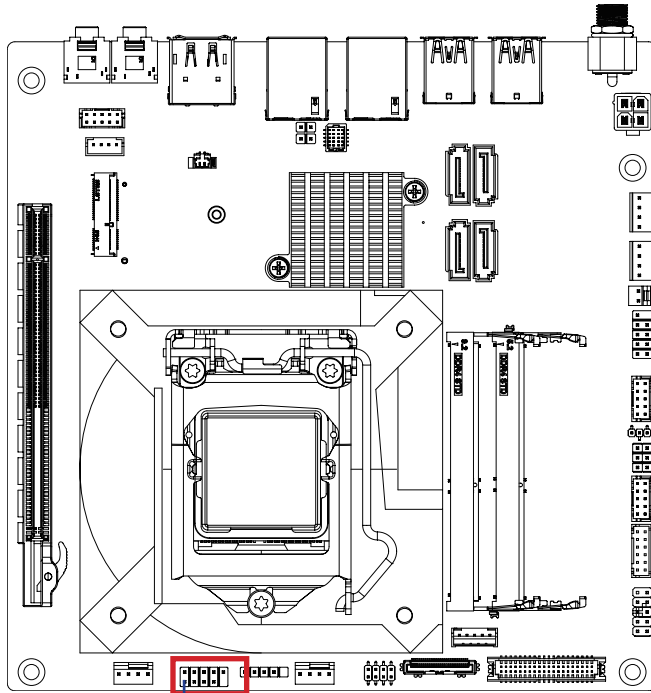

Pin 1

USB 2.0 Header

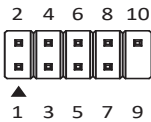

Connector PN

210-92-05GB04

PH10R53BAZ009

Vendor

PINREX

HORNGTONG

Pin No.	Definition
1	5V
2	5V
3	D2n
4	D1n
5	D2p
6	D1p
7	GND
8	GND
9	No Pin
10	NC

2.2.15 FUSB2_1 (USB 2.0 Header)

16

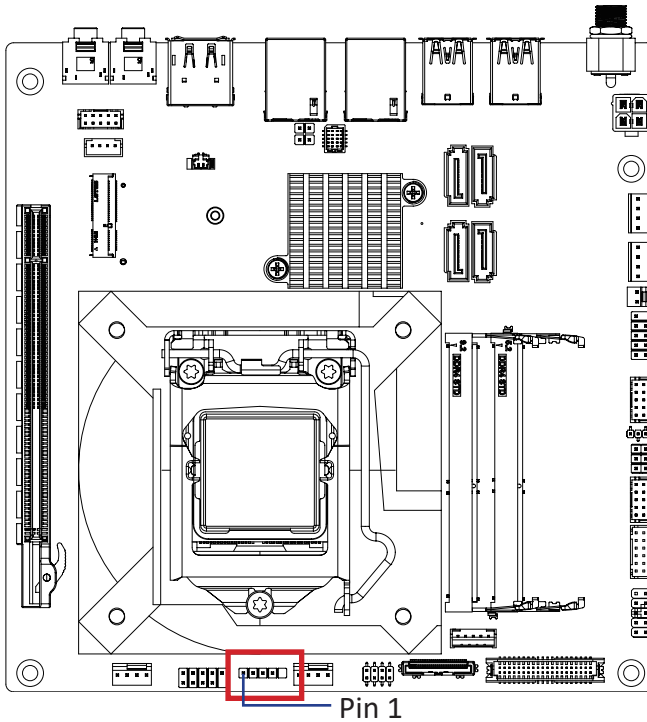

Pin 1

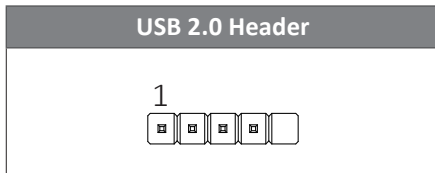

Connector PN	Vendor
210-91-05GB02	PINREX
PH05R23BAZ005	HORNGTONG

Pin No.	Definition
1	5V
2	Dn
3	Dp
4	GND

2.2.16 SYS_FAN (System Fan Connector)

17

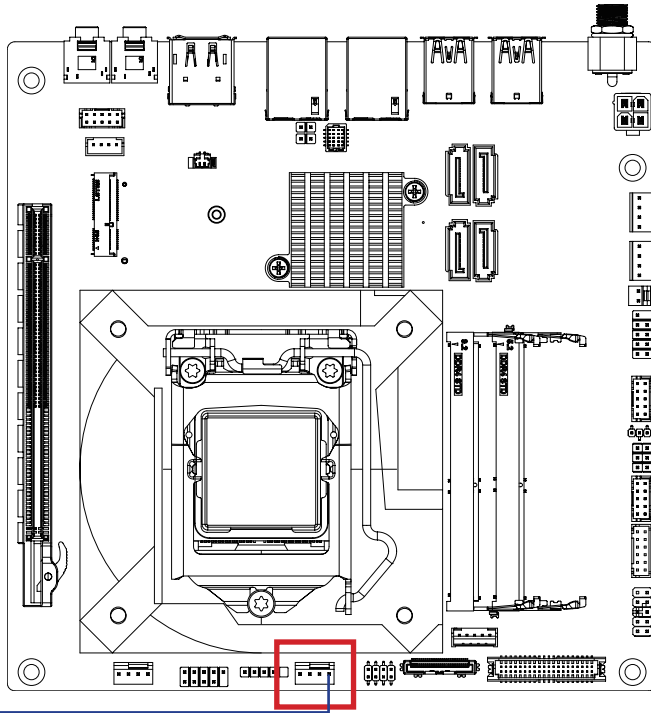

Pin 1

System FAN connector		
4		1









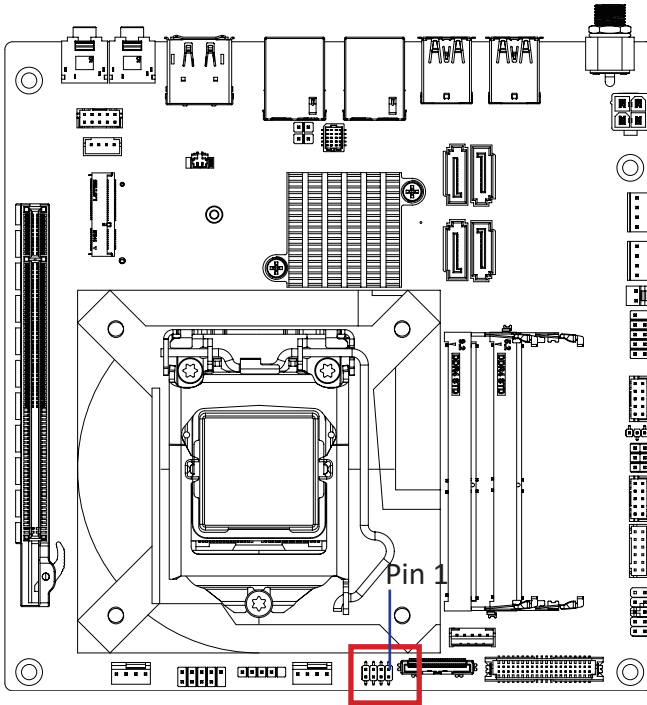







Connector PN	Vendor
744-81-045R11	PINREX
WF04R22RJQ105	HORNGTONG

Pin No.	Definition
1	GND
2	12V
3	Detect
4	Speed Control

2.2.17 LSW (LVDS Resolution Jumper)

18



LVDS Resolution Jumper			
Jumper Setting	Resolution	Jumper Setting	Resolution
8  1	800 x 600 18bit	8  1	1366 x 768 24bit
8  1	1024 x 768 18bit	8  1	1440 x 900 24bit
8  1	1024 x 768 24bit	8  1	1400 x 1050 24bit
8  1	1024 x 600 18bit	8  1	1600 x 900 24bit
8  1	1280 x 800 18bit	8  1	1680 x 1050 24bit
8  1	1280 x 960 18bit	8  1	1600 x 1200 24bit
8  1	1280 x 1024 24bit	8  1	1920 x 1080 24bit
8  1	1366 x 768 18bit	8  1	1920 x 1200 24bit

Connector PN	Vendor
222-97-04GBE1	PINREX

2.2.18 EDP (Embedded Display Port connector)

19

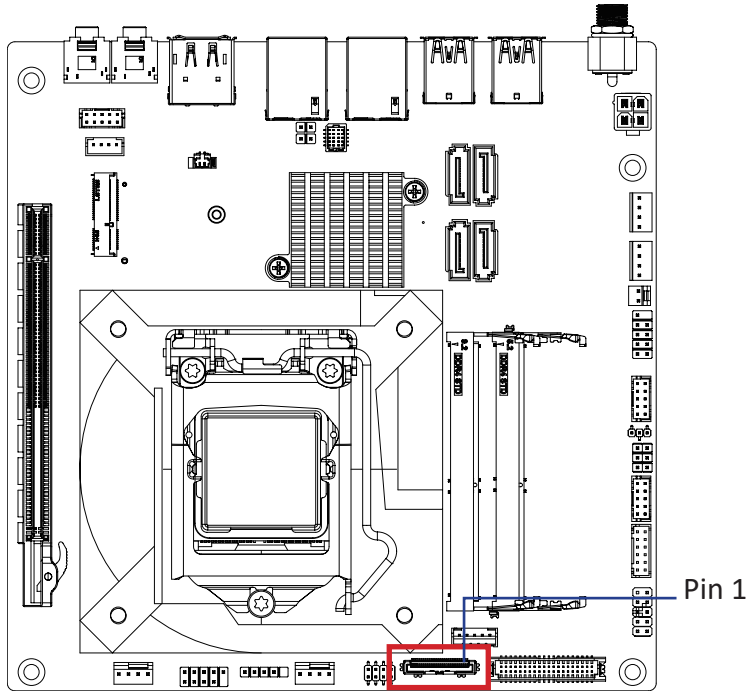

Embedded Display Port connector

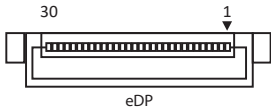

Pin No.	Definition	Pin No.	Definition
1	GND	16	GND
2	TX0n	17	Hot Plug Detect
3	TX0p	18	Backlight Enable
4	GND	19	GND
5	TX1n	20	Backlight control
6	TX1p	21	GND
7	GND	22	3.3V
8	TX2n	23	3.3V
9	TX2p	24	3.3V

Pin No.	Definition	Pin No.	Definition
10	GND	25	3.3V
11	TX3n	26	GND
12	TX3p	27	5V
13	GND	28	5V
14	AUXn	29	5V
15	AUXp	30	5V

Connector PN	Vendor
115B30-000040-G4-R	STARCONN

2.2.19 BKL_CN (Backlight Control Connector)

20

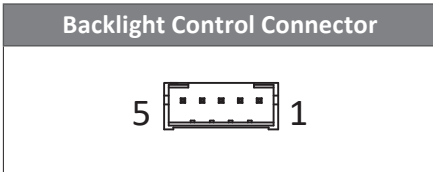
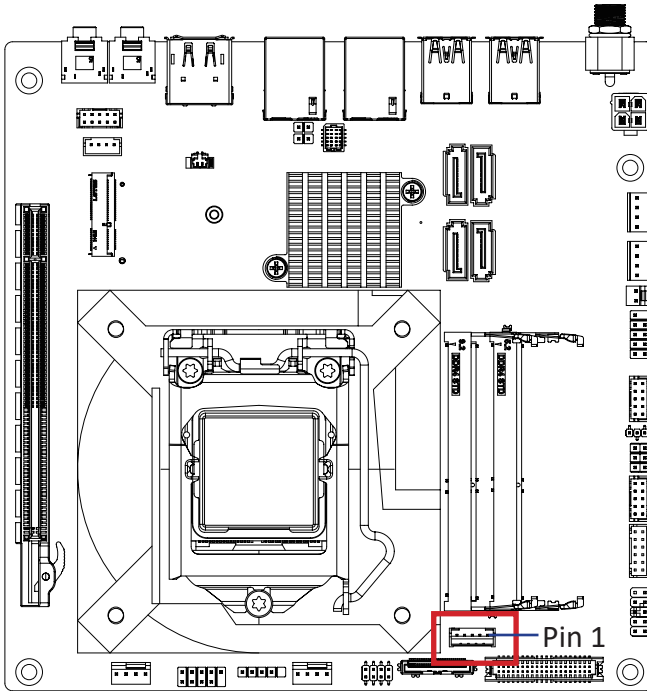

Connector PN	Vendor
721-81-05TW00	PINREX
A2001WV-05P146	JOINT-TECH

Pin No.	Definition
1	5V
2	PWM
3	Backlight enable
4	GND
5	12V

2.2.20 LVDS (LVDS Connector)

21

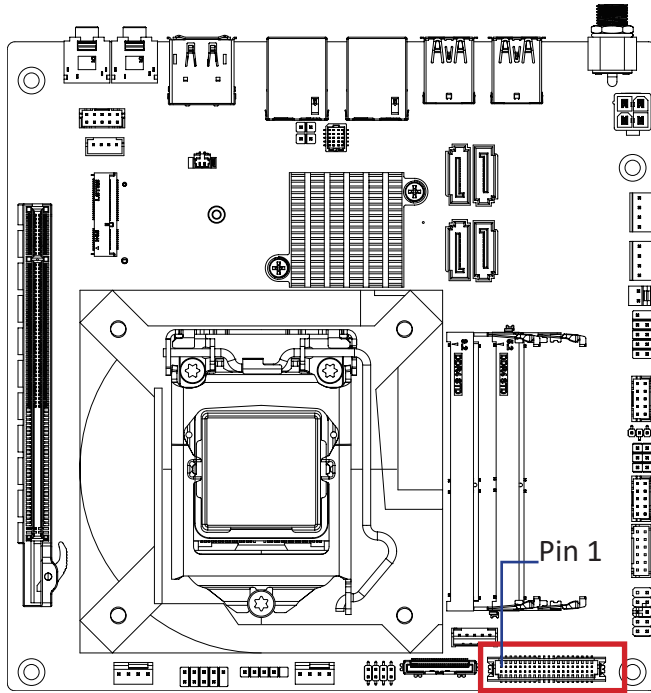

LVDS Connector

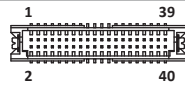

Pin No.	Definition	Pin No.	Definition
1	3.3V	21	A5+
2	5V	22	A4+
3	3.3V	23	A5-
4	5V	24	A4-
5	SPECO	25	GND
6	SPEDO	26	GND
7	GND	27	A7+
8	GND	28	A6+
9	A1+	29	A7-
10	A0+	30	A6-
11	A1-	31	GND
12	A0-	32	GND
13	GND	33	CLK2+
14	GND	34	CLK1+
15	A3+	35	CLK2-
16	A2+	36	CLK1-

Pin No.	Definition	Pin No.	Definition
17	A3-	37	GND
18	A2-	38	GND
19	GND	39	12V
20	GND	40	12V

Connector PN	Vendor
712-76-40GWE0	PINREX
A1252WV-SF-2X20PD01	JOINT-TECH

For each model support LVDS function. But below model no need to add. A0~A3 is odd channel 0~3, A4~A7 is even channel.

Note: *The LVDS output connector of the unit is only intended to be connected to an UL/IEC/EN approval equipment with fire enclosure.

2.2.21 SYS_PANEL (System Panel Header)

22

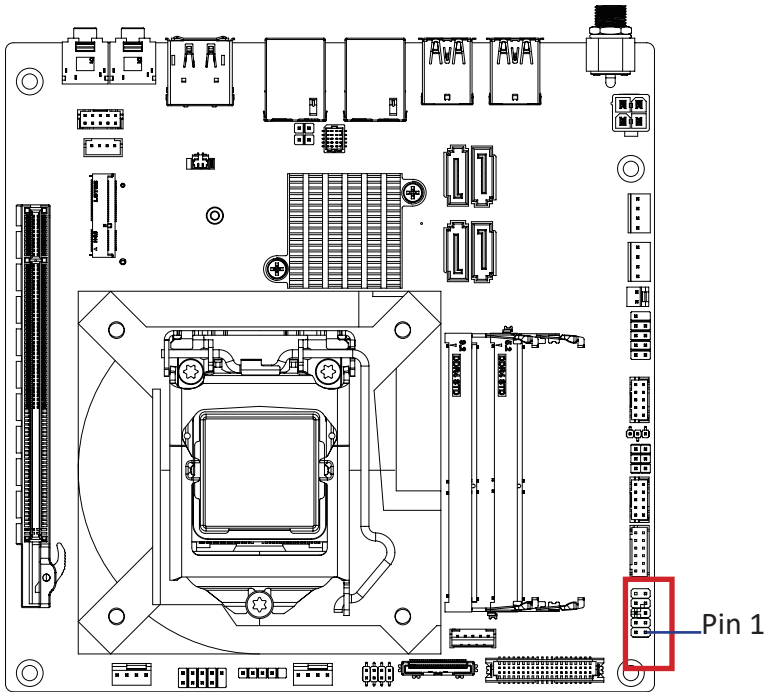

System Panel Header	

Connector PN	Vendor
210-92-05GW5W	PINREX

Pin No.	Definition
1	HD-p
2	MPD-p
3	HD-n
4	MPD-n
5	GND
6	POWER-ON
7	Reset
8	GND
9	Reserved
10	NC

2.2.22 GPIO_CNT (General purpose input/output Connector)

23

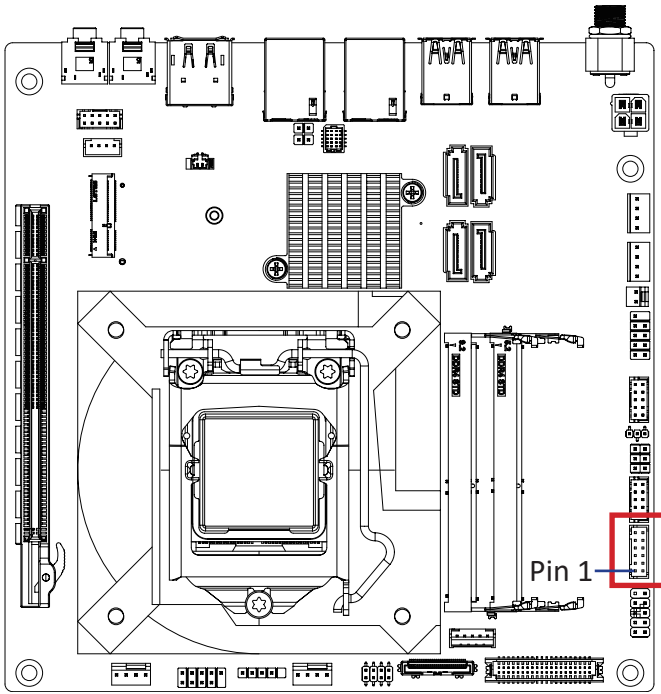

GPIO Connector

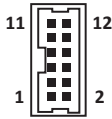

Pin No.	Definition
1	GPIO-output_1
2	GPIO-input_1
3	GPIO-output_2
4	GPIO-input_2
5	GPIO-output_3
6	GPIO-input_3
7	GPIO-output_4
8	GPIO-input_4

Pin No.	Definition
9	SMBus Clock
10	SMBus DATA
11	5V
12	GND

Connector PN	Vendor
725-81-12TW00	PINREX
A2004WV-2X06P46	JOINT-TECH

2.2.23 COM1 (COM header RS-232/422/485 & RI/5V/12V)

24

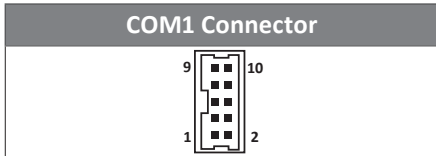
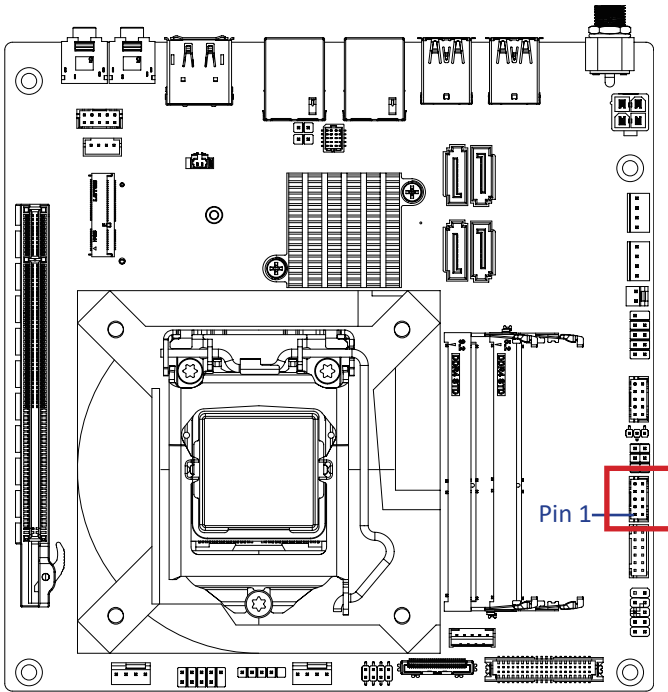

Connector PN	Vendor
725-81-10TW00	PINREX
A2004WV-2X05P46	JOINT-TECH

Pin No.	RS-232	RS-422 Full Duplex	RS-485 Half Duplex
1	RXD	TXD+	D+
2	DCD	TXD-	D-
3	DTR	RXD-	-
4	TXD	RXD+	-
5	DSR	-	-
6	GND	-	-
7	CTS	-	-
8	RTS	-	-
9	No Connect	-	-
10	RI	-	-

2.2.24 JCOM1 (RI# pin RI#/5V/12V Select for COM1 Port)

25

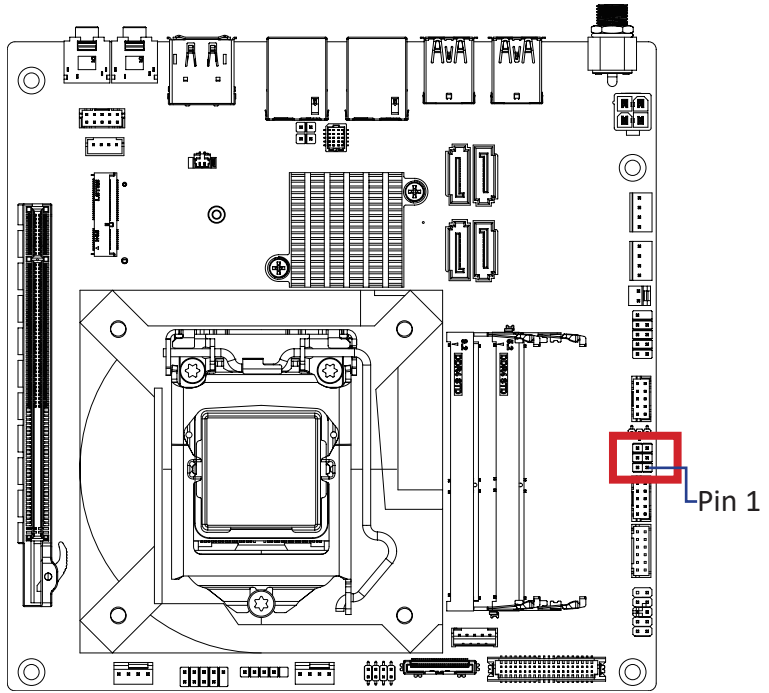

JCOM1 Jumper Select	
	1-2 Close: 5V (Power COM)
	3-4 Close: RI (Stand COM)
	5-6 Close: 12V (Power COM)

Connector PN	Vendor
210-92-03GB01	PINREX
PH06R53BAZ000	HORNGTONG

2.2.25 AT_CN (AT/ATX mode select jumper)

26

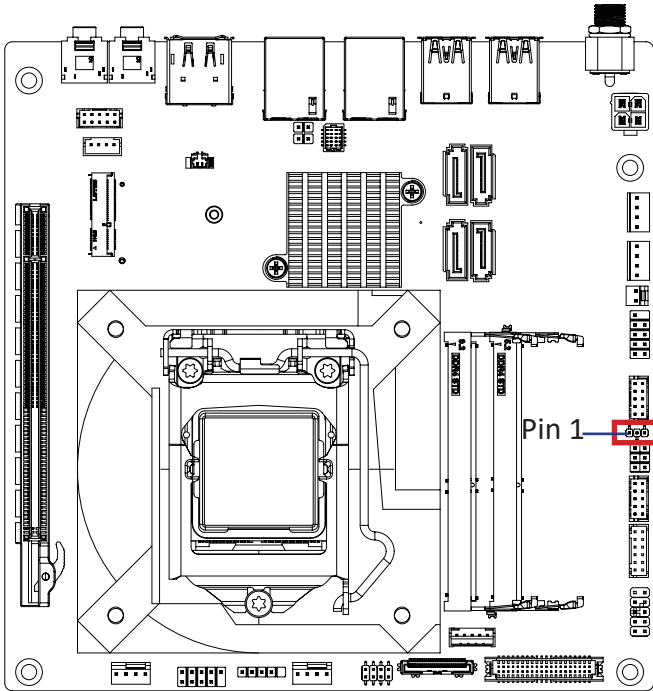

AT/ATX mode select jumper



1

Connector PN

222-96-03GBE1

Vendor

PINREX

Pin No.	Definition
1	AT MODE
2	Detect
3	ATX MODE

Jumper setting
 1-2 Close : AT mode.
 2-3 Close : ATX mode.(Default setting)

2.2.26 COM2 (COM header (RS-232))

27

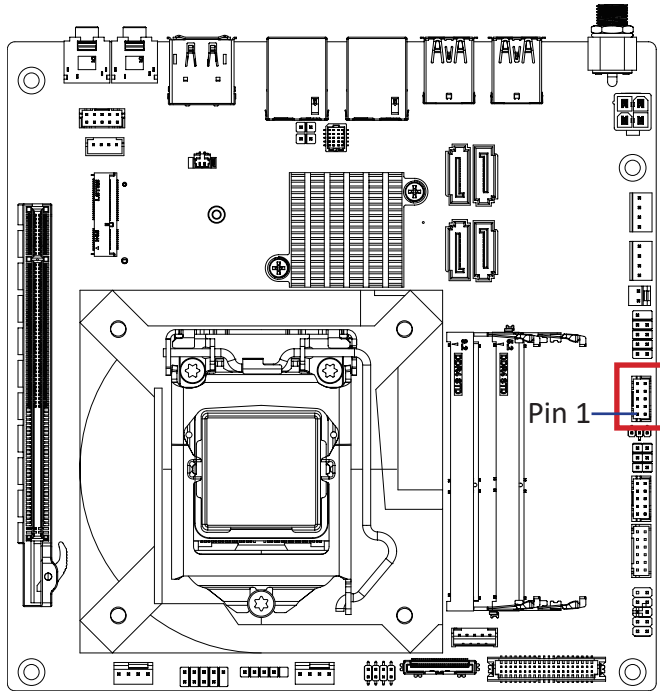

COM2 Header

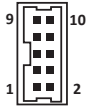

Connector PN

725-81-10TW00

A2004WV-2X05P46

Vendor

PINREX

JOINT-TECH

Pin No.	Definition
1	RXD
2	DCD
3	DTR
4	TXD
5	DSR
6	GND
7	CTS
8	RTS
9	NC
10	RI

2.2.27 FUSB2_3 (USB 2.0 Header)

28

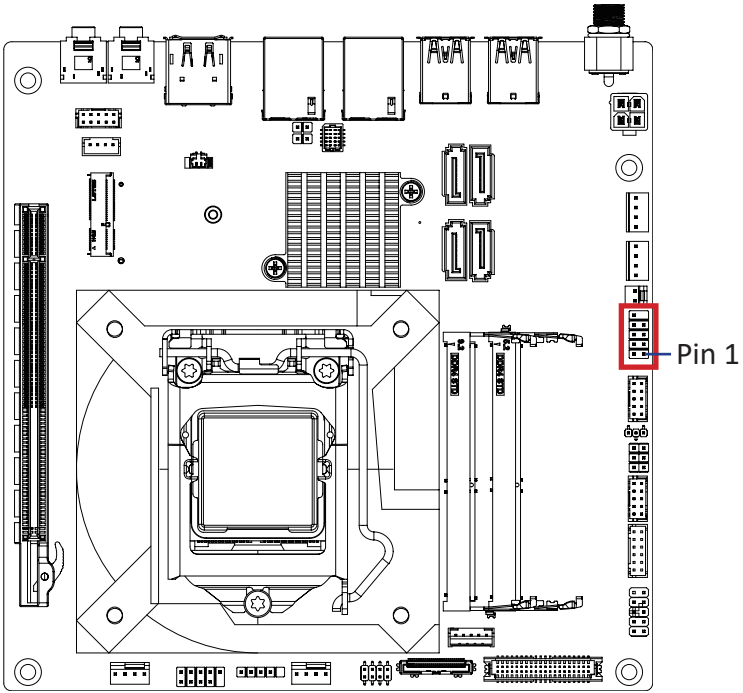

USB 2.0 Header

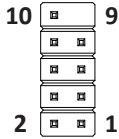

Connector PN

210-92-05GB04
PH10R53BAZ009

Vendor

PINREX
HORNGTONG

Pin No.	Definition
1	5V
2	5V
3	D2n
4	D1n
5	D2p
6	D1p
7	GND
8	GND
9	No Pin
10	NC

2.2.28 ATX_CTL (ATX Control Header, Support PS-ON Signal of Power Supply Unit)

29

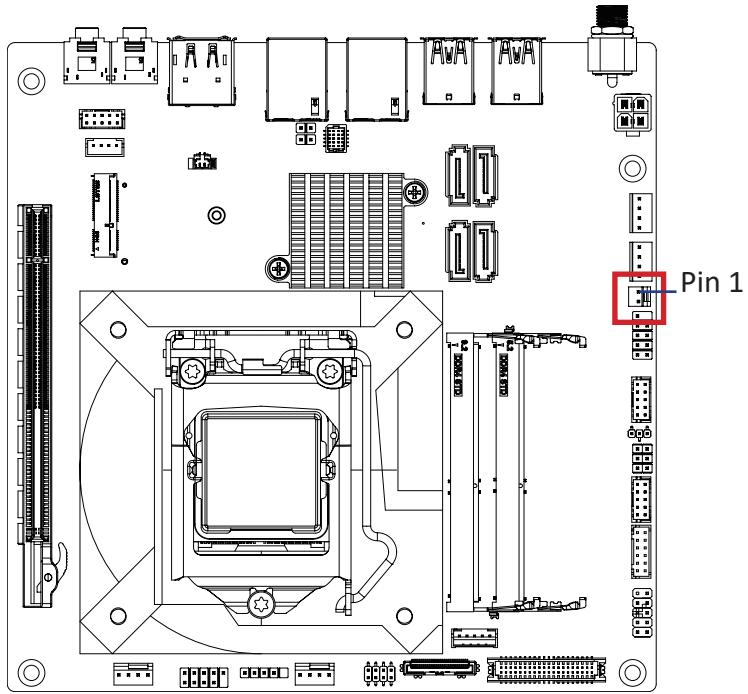

ATX Control Header

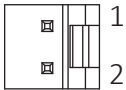

Connector PN

744-81-02TW10

Vendor

PINREX

Pin No.	Definition
1	PSON#
2	5V

2.2.29 SATA_PWR1, SATA_PWR2 (SATA Power Connector x2)

30

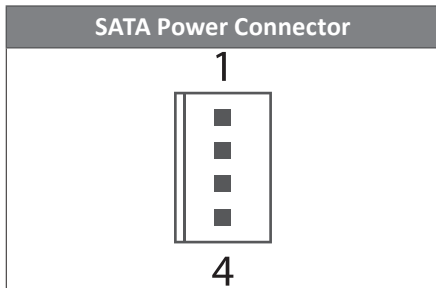
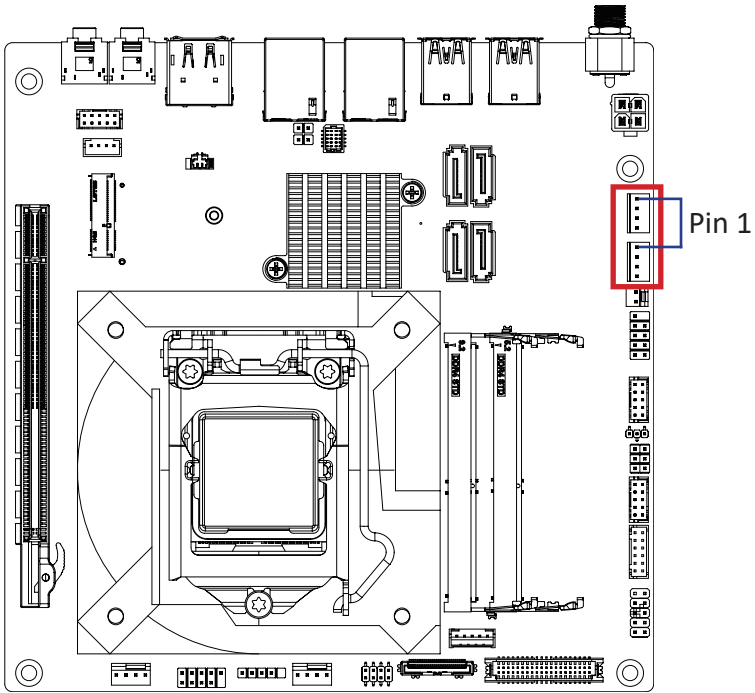

Connector PN	Vendor
743-81-04TW00	PINREX
WF04Q2-3BJQ000	HORNGTONG

Pin No.	Definition
1	5V
2	GND
3	GND
4	5V

2.2.30 CLR_CMOS (Clear CMOS Jumper)

31

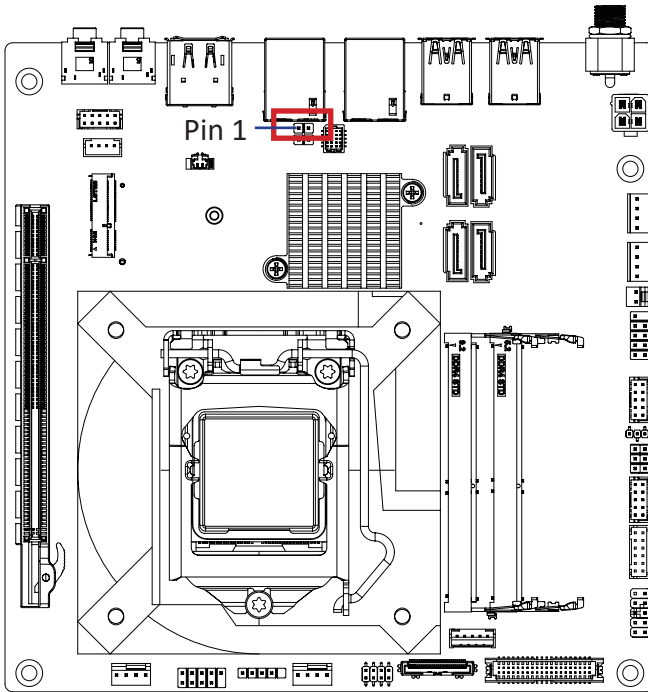

Clear CMOS Jumper



Pin No.	Definition
1	Clear CMOS
2	GND
Open: Normal Operation (Default setting) Close: Clear CMOS data.	

2.2.31 ME_EN (ME Enable Jumper)

32

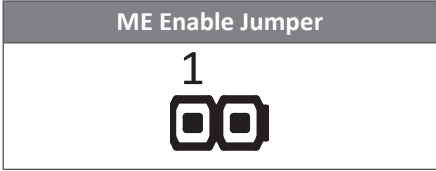
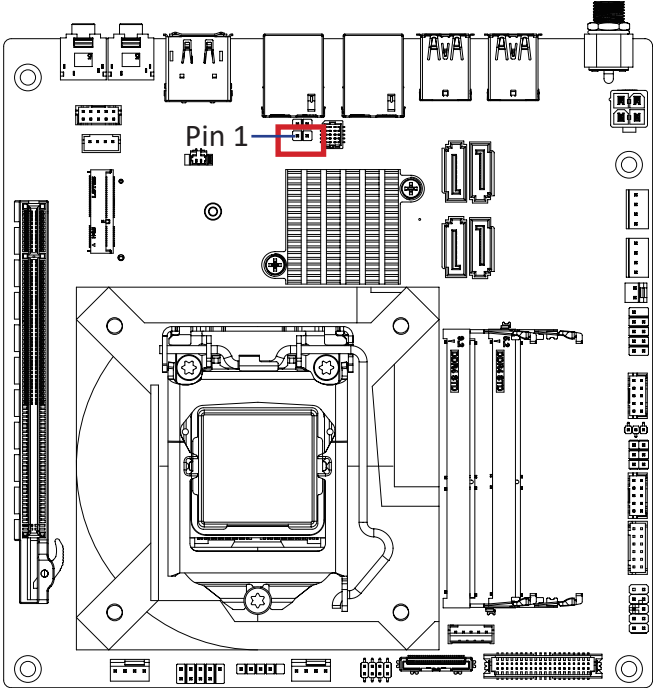

ME Enable Jumper	
	Enable
	Disable

2.2.32 SODIMM1, SODIMM2 (2 x DDR4 SO-DIMM Sockets)

33

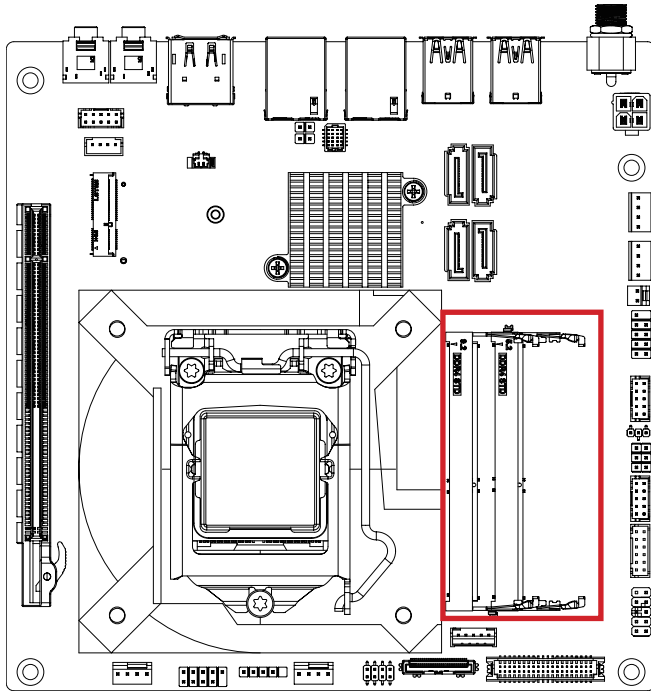

2.2.33 M2_M (M.2 Slot, 2280 M-Key)

34

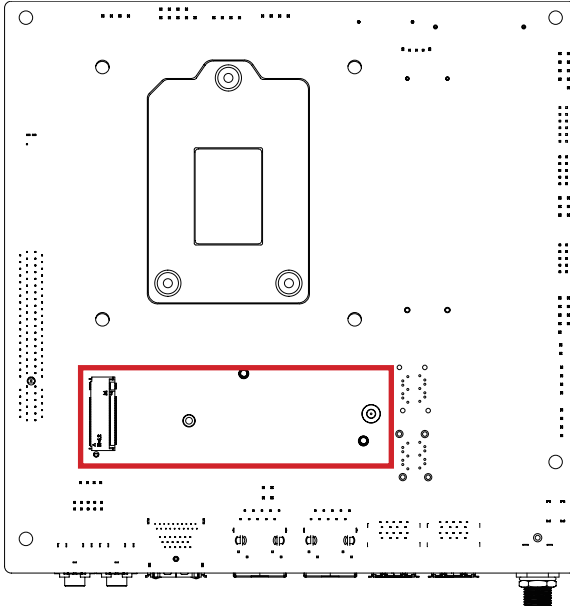

M.2 M Key Connector



Pin No.	Definition	Pin No.	Definition
1	GND	2	3.3V
3	GND	4	3.3V
5	PCIE3 RXn	6	NC
7	PCIE3 RXp	8	NC
9	GND	10	NC
11	PCIE3 TXn	12	3.3V
13	PCIE3 TXp	14	3.3V
15	GND	16	3.3V
17	PCIE2 RXn	18	3.3V
19	PCIE2 RXp	20	NC
21	GND	22	NC
23	PCIE2 TXn	24	NC
25	PCIE2 TXp	26	NC
27	GND	28	NC
29	PCIE1 RXn	30	NC
31	PCIE1 RXp	32	NC
33	GND	34	NC

Pin No.	Definition	Pin No.	Definition
35	PCIE1 TXn	36	NC
37	PCIE2 TXp	38	DEVSLP
39	GND	40	SMB Clock
41	PCIE0 RXn	42	SMB DATA
43	PCIE0 RXp	44	SMB ALT
45	GND	46	NC
47	PCIE0 TXn	48	NC
49	PCIE0 TXp	50	PCI Reset
51	GND	52	PCIE Clock Request
53	PCIE Clock-	54	NC
55	PCIE Clock+	56	NC
57	GND	58	NC

Pin No.	Definition	Pin No.	Definition
67	NC	68	SUSCLK
69	Detect	70	3.3V
71	GND	72	3.3V
73	GND	74	3.3V
75	GND		

Connector PN	Vendor
APCI0073-P001A	LOTES
AS0BC21-S40BM-7H	FOXCONN

Chapter 3

Chapter 3 – BIOS

3.1 Introduction

BIOS (Basic input/output system) provides hardware detailed information and boot-up options, which include firmware to control, set-up and test all hardware settings. Therefore, BIOS is the communication bridge between OS/application software and hardware.

3.1.1 How to Entering into BIOS menu

Once the system is power on, press the key as soon as possible to access into BIOS Setup program.

3.1.2 Function Keys to setup in BIOS Setup program

Function keys	Description
→←	Select Screen
↑↓	Select Item
Enter	Execute command or enter the submenu
+	Increase the numeric value or make changes
—	Decrease the numeric value or make changes
F1	General Help
F2	Previous Values
F3	Load Optimized Defaults Settings
F4	Save changes & Exit the BIOS Setup program
ESC	Exit the BIOS Setup program

3.2 The Main Menu

The main menu shows the basic system information. Use arrow keys to move among the items.

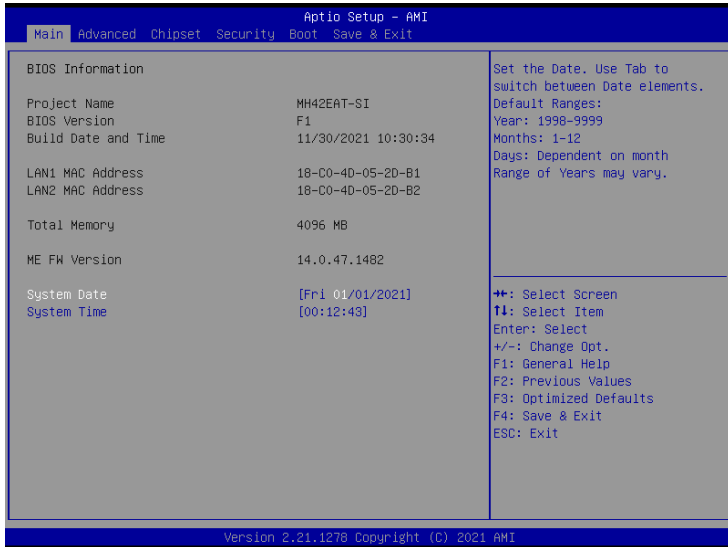

Items	Description
Project Name	Shows Project name information
BIOS Version	Shows the BIOS version of the system
Build Date and Time	Shows the Build Date and Time when the BIOS was created.
LAN1 MAC Address	Shows LAN 1 MAC Address information
LAN2 MAC Address	Shows LAN 2 MAC Address information
Total Memory	Shows the total memory size of the installed memory
ME FW version	Shows ME firmware version
System Date	Set the Date for the system (Format : Week - Month - Day - Year)
System Time	Set the time for the system (Format : Hour - Minute - Second)

3.3 Advanced

The Advanced menu is to configure the functions of hardware settings through submenu. Use arrow keys to move among the items, and press <Enter> to access into the related submenu.

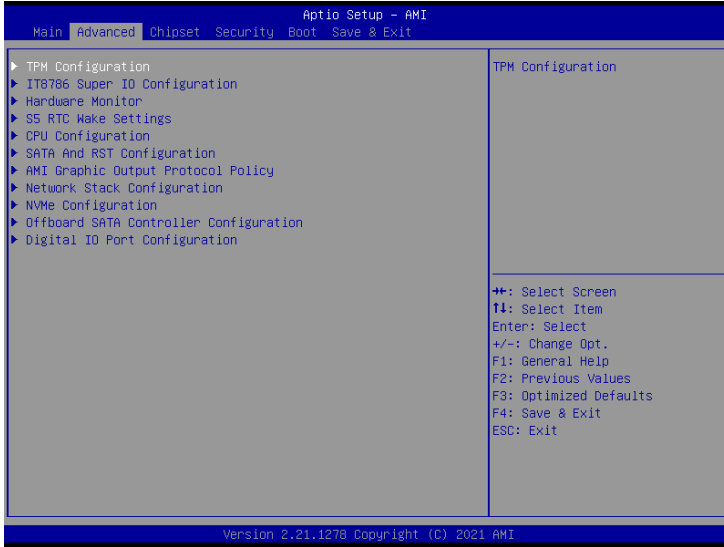

3.3.1 TPM Configuration

Use TPM Configuration submenu to choose TPM interface.



Item	Description
TPM Device Selection	PTT : Internal TPM (Default setting) dTPM : External TPM (When using External TPM module or having TPM chip on MB)

Trusted Computing : Shows TPM information, and TPM module configuration setting.

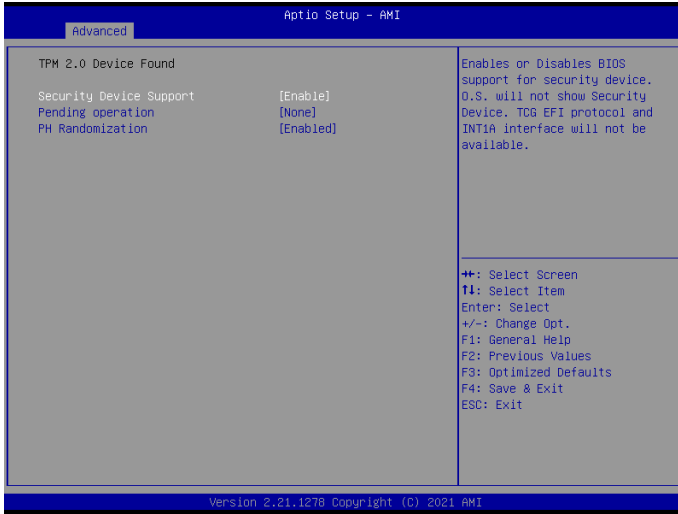

Item	Description
Security Device Support	Enabled : Enables TPM feature (Default setting) Disabled : Disables TPM feature
Pending operation	None : No execution will be conducted (Default setting) TPM clear : Set to clear data on TPM
PH Randomization	Enabled : Enables Platform Hierarchy (PH) Randomization. (Default setting) Disabled : Disables Platform Hierarchy (PH) Randomization.

3.3.2 IT8786 Super IO Configuration

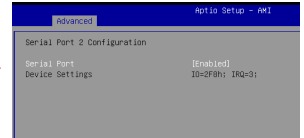
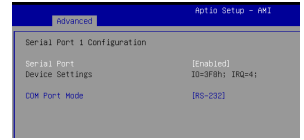
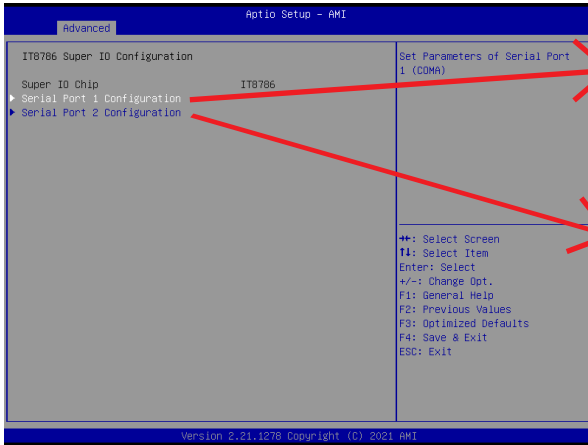

Item	Description
Super IO Chip	Shows Super I/O chip model
Serial Port 1 Configuration	<p>Press [Enter] to configure advanced items :</p> <p>Serial Port : Enabled : Enables allows you to configure the serial port settings Disabled : if Disabled, displays no configuration for the serial port</p> <p>Device settings : Display the specified Serial Port base I/O address and IRQ</p> <p>COM Port Mode : Choose RS-232, RS-422, or RS-485 feature</p>
Serial Port 2 Configuration	<p>Press [Enter] to configure advanced items :</p> <p>Serial Port : Enabled : Enables allows you to configure the serial port settings Disabled : if Disabled, displays no configuration for the serial port</p> <p>Device settings : Display the specified Serial Port base I/O address and IRQ</p>

3.3.3 Hardware Monitor

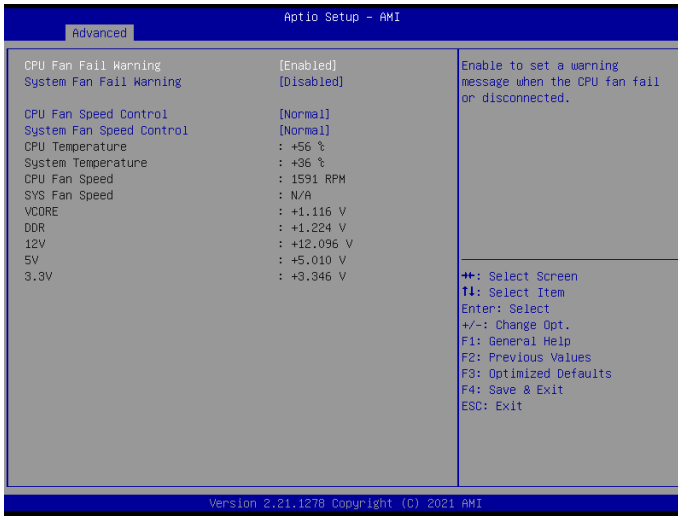

Item	Description
CPU Fan Fail Warning	Enabled : Enables CPU FAN Fail warning alert function (Default setting) Disabled : Disables CPU FAN Fail warning alert function
System Fan Fail Warning	Enabled : Enables System FAN Fail warning alert function Disabled : Disables System FAN Fail warning alert function (Default setting)
CPU Fan Speed Control	Normal : Fan speed set by BIOS default (Default setting) Full Speed : Set Fan operates at full speed
System Fan Speed Control	Normal : Fan speed set by BIOS default (Default setting) Full Speed : Set Fan operates at full speed
CPU Temperature	Shows current CPU temperature
System Temperature	Shows current system temperature
CPU Fan Speed	Shows current CPU fan Speed
SYS Fan Speed	Shows current System fan Speed

3.3.4 S5 RTC Wake Settings



Item	Description
<p>Wake system from S5</p>	<p>Enable or Disable System to wake on a specific time. Disabled : Disables system to wake on a specific time (Default setting) Fixed Time : Enables system to wake on a specific time (Format : hr : min : sec)</p>

3.3.5 CPU Configuration

This submenu shows detailed CPU informations.

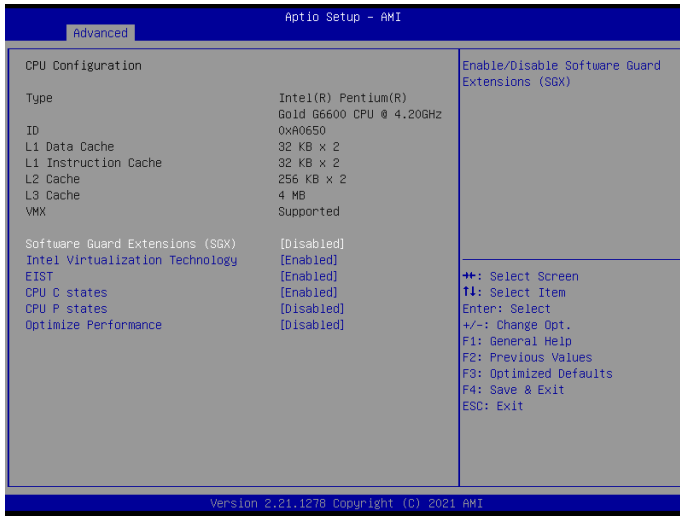

Item	Description
Software Guard Extensions (SGX)	Disabled : Disables Software Guard Extensions (SGX) (Default setting) Enabled : Enables Software Guard Extensions (SGX) Software Controlled : If this item is selected, SGX will be controlled by SGX application for UEFI boot OS
Intel Virtualization Technology	Virtualization enhanced by Intel® Virtualization Technology will allow a platform to run multiple operating systems and applications in independent partitions. With virtualization, one computer system can function as multiple virtual systems. Enabled : Enables Intel Virtualization Technology (Default setting) Disabled : Disables Intel Virtualization Technology
EIST	According to System loading, Enhanced Intel SpeedStep Technology (EIST) will automatically adjust the CPU voltage and core frequency to decrease heat and power consumption for power saving. Enabled : Enables EIST Technology (Default setting) Disabled : Disables EIST Technology
CPU C states	Command CPU to enter into low power consumption mode when CPU is under idle mode. Enabled : Enables CPU C states function (Default setting) Disabled : Disables CPU C states function
CPU P states	CPU will adjust frequency depends on it's loading. Enabled : Enables CPU P states function Disabled : Disables CPU P states function (Default setting)
Optimize Performance	To optimize CPU performance. Enabled : Enables optimize performance function Disabled : Disables optimize performance function (Default setting)

3.3.6 SATA And RST Configuration

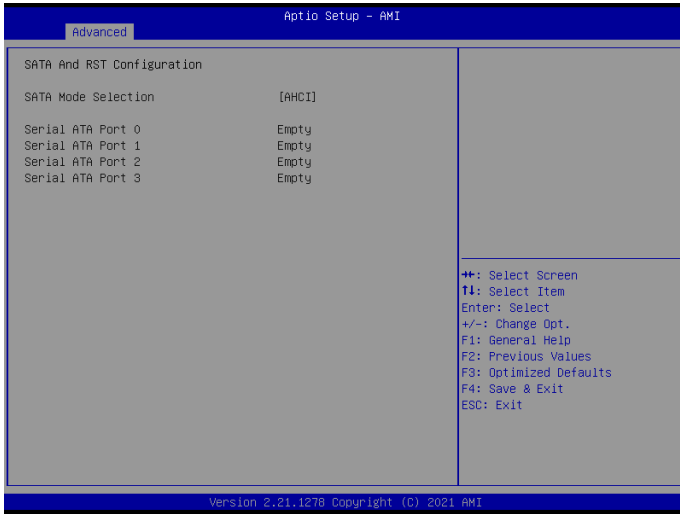

Item	Description
SATA Mode Selection	Set SATA controller to AHCI mode
Serial ATA Port 0	shows 2.5" SATA HDD/SSD information
Serial ATA Port 1	
Serial ATA Port 2	
Serial ATA Port 3	

3.3.7 AMI Graphic Output Protocol Policy

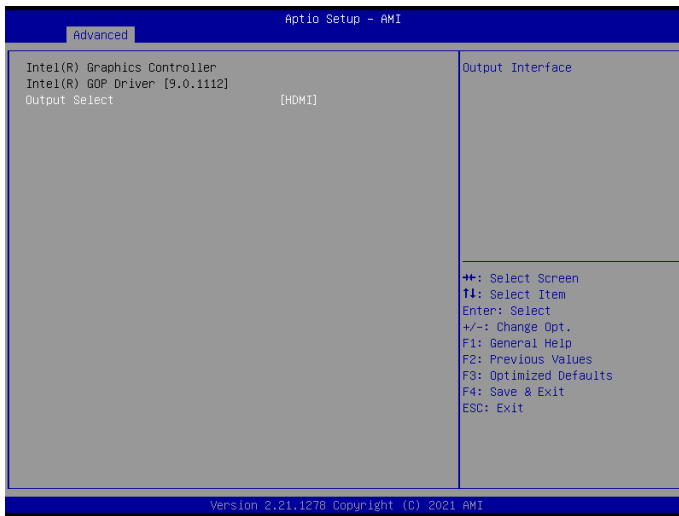

Item	Description
Output Select	Choose default monitor output when there are more than one monitor plugged on the motherboard.

3.3.8 Network Stack Configuration

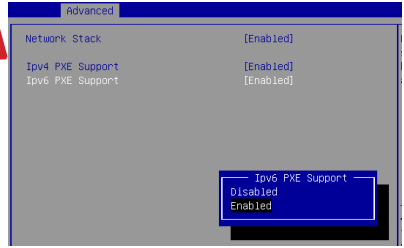
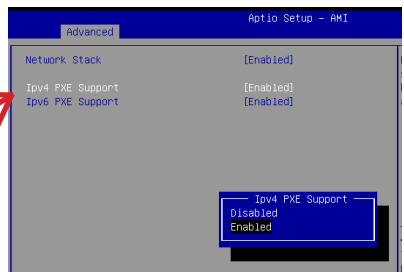
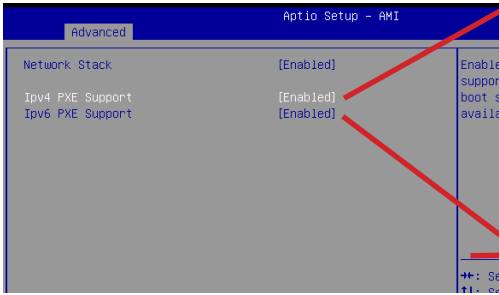
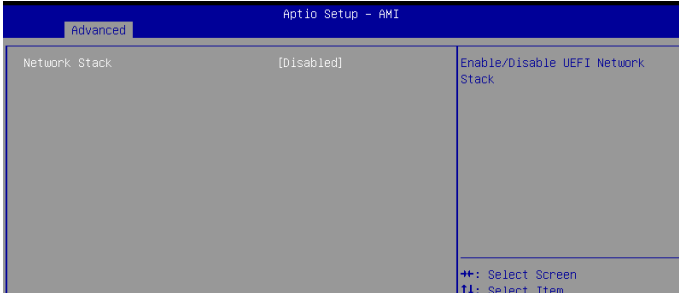

Item	Description
Network Stack	When system is power on, install LAN driver under UEFI mode Disabled : Disables UEFI Network Stack (Default setting) Enabled : Enables UEFI Network Stack
Ipv4 PXE Support	When Network stack is enabled : Disabled : Disables Ipv4 PXE Support Enabled : Enables Ipv4 PXE Support
Ipv6 PXE Support	When Network stack is enabled : Disabled : Disables Ipv6 PXE Support Enabled : Enables Ipv6 PXE Support

3.3.9 NVMe Configuration

NVMe Configuration shows information when your M.2 NVMe PCIe SSD is installed.

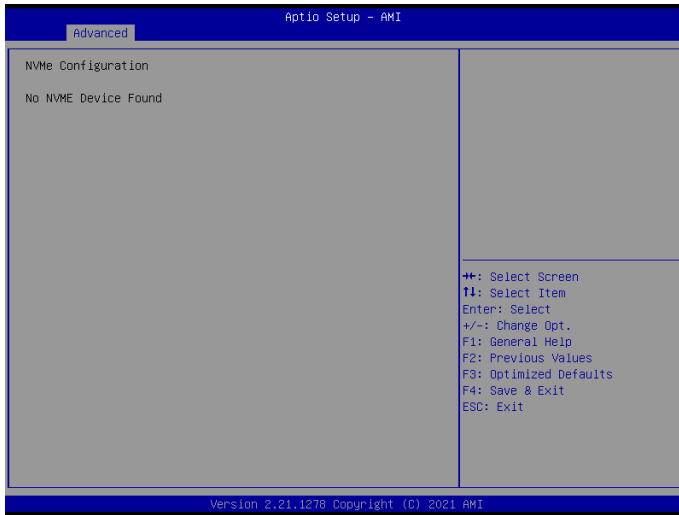

3.3.10 Offboard SATA Controller Configuration

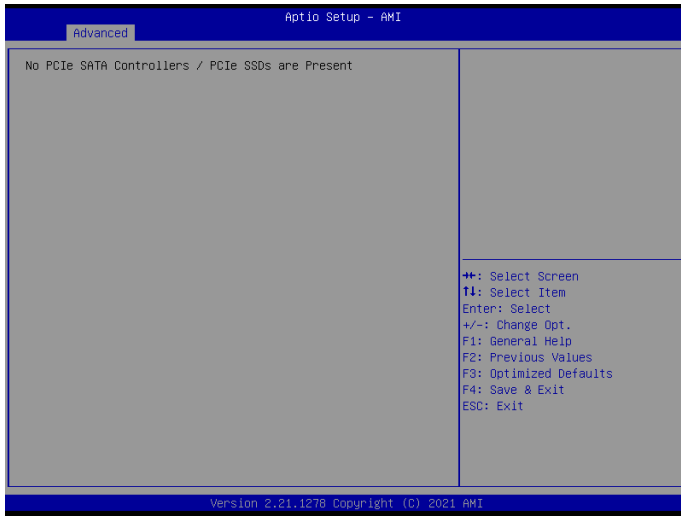

3.3.11 Digital IO Port Configuration

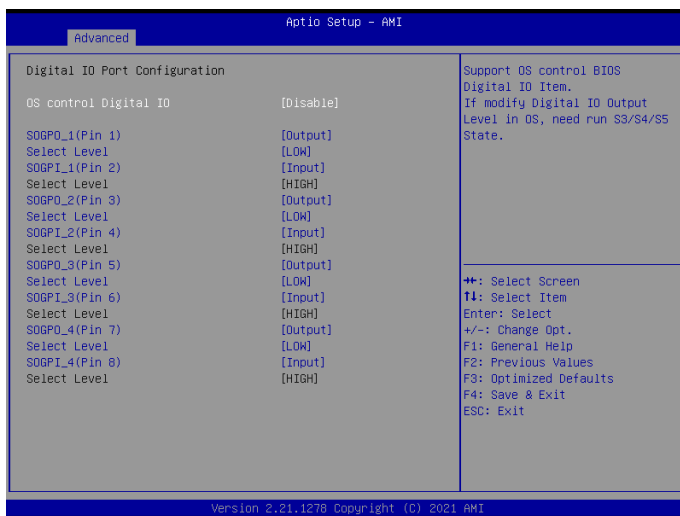

Item	Description
<p>OS control Digital IO</p>	<p>Disabled : If Digital IO Output value/level is modified in OS, they will not be memorized and kept. (Default setting) Enabled : If Digital IO Output value/level is modified in OS, they will be memorized and kept.</p>
<p>SOGPO_1 (Pin 1) SOGPI_1 (Pin 2) SOGPO_2 (Pin 3) SOGPI_2 (Pin 4) SOGPO_3 (Pin 5) SOGPI_3 (Pin 6) SOGPO_4 (Pin 7) SOGPI_4 (Pin 8)</p>	<p>Configure Digital IO Input or Output values for each pin.</p>

3.4 Chipset

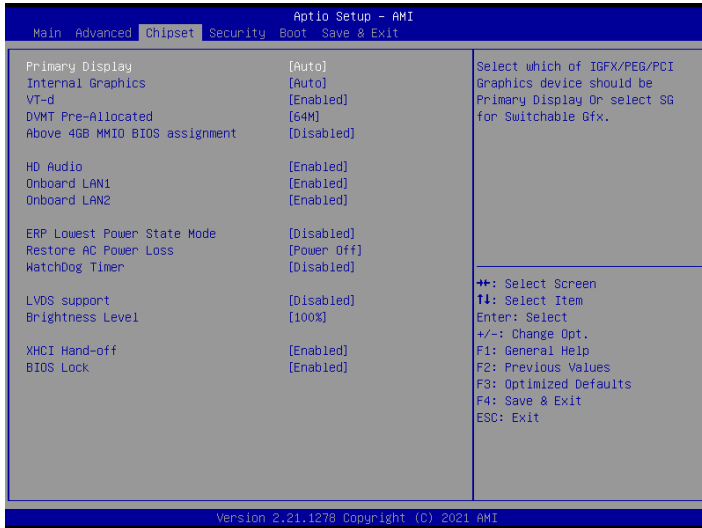

Item	Description
Primary Display	Auto : When detects PCIe Graphic card, primary display will set to PCIe (Default setting) IGFX : Force IGFX Graphic card as the primary display device PEG : Force PEG Graphic card as the primary display device
Internal Graphics	Enables or disables the onboard graphics function Auto : Detects display device automatically (Default setting) Enabled : Enables onboard graphics Disabled : Disables onboard graphics
VT-d	Enabled : Enables VT-d function (Default setting) Disabled : Disables VT-d function
DVMT Pre-Allocated	Use DVMT Pre-Allocated to set the amount of system memory which is installed to the integrated graphics processor Option items : 32M , 64M(Default setting), 128M, 256M
Above 4GB MMIO BIOS assignment	Enable or disable to re-allocate memory space for device cards when more than one external graphic cards installed. (This function could be only used under 64 bit operating system with above 4 GB address space) Enabled : Enables Above 4GB MMIO BIOS assignment function Disabled : Disables Above 4GB MMIO BIOS assignment function (Default setting)
HD Audio	Enable/Disable onboard audio controller Enabled : Enables onboard audio controller (Default setting) Disabled : Disables onboard audio controller

Onboard LAN1 Onboard LAN2	Enable/Disable onboard LAN controller Enabled : Enables onboard LAN controller (Default setting) Disabled : Disables onboard LAN controller
ERP Lowest Power State Mode	Enable/Disable power saving funtion Enabled : Enables ERP Lowest Power State Mode Disabled : Disabled ERP Lowest Power State Mode (Default setting)
Restore AC Power Loss	To set which option the system should returns if a sudden power loss occurred Power off : Do not power on when the power is back (Default setting) Power on : System power on when the power is back Last state : Restore the system to the state before power loss occurs
Watchdog Timer	Enable/Disable Watchdog Timer function Disabled : Disabled Watchdog Timer function (Default setting) 30s : delay watchdog for 30 seconds. 60s : delay watchdog for 60 seconds.
LVDS Support	Disabled : Disables LVDS Support (Default setting) Enabled : Enables LVDS Support
Brightness Level	To modified the backlight brightness of the LVDS panel Option items : 10%, 20%, 30%, 40%, 50%, 60%, 70%, 80%, 90%, 100% (Default Setting)
XHCI Hand-off	Enable/Disable XHCI Hand-off function Enabled : Enables XHCI Hand-off function (Default setting) Disabled : Disables XHCI Hand-off function
BIOS Lock	Enable/Disable BIOS Lock function Enabled : Enables BIOS Lock function (Default setting) Disabled : Disabled BIOS Lock funtion

3.5 Security



Item	Description
Administrator Password	To set up Administrator's password Minimum length : 3 Maximum length : 20
User Password	To set up User's password Minimum length : 3 Maximum length : 20
Secure Boot	Press <Enter> to configure the advanced items



Item	Description
Secure Boot	Secure Boot requires all the applications that are running during the booting process to be pre-signed with valid digital certificates Enabled : Enables Secure Boot function Disabled : Disables Secure Boot function (Default setting)
Secure Boot Mode	Standard : Standard mode Custom : Custom mode (Default setting)
Restore Factory Keys	To restore factory settings Yes : Agree to restore factory settings No : Cancel to restore factory settings
Reset To Setup Mode	Yes : Agree to setup mode No : Cancel to setup mode
Key Management	Enables expert users to modify Secure boot policy variables without full authentication Press <Enter> to configure the advanced items

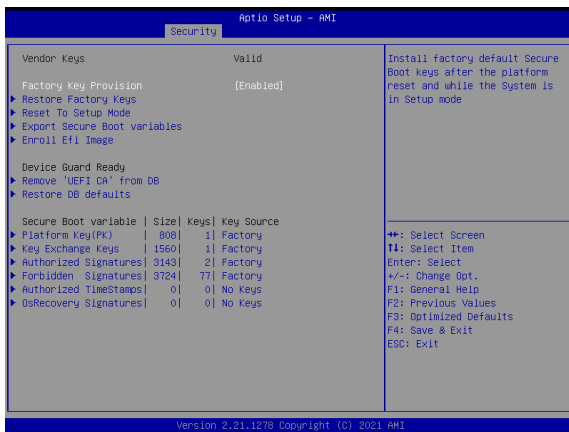

Item	Description
Factory Key Provision	Install factory default Secure Boot keys after the platform reset and while the system is in Setup mode Enabled : Enables Factory Key Provision (Default setting) Disabled : Disables Factory Key Provision
Restore Factory Keys	To restore factory settings Yes : Agree to restore factory settings No : Cancel to restore factory settings
Reset To Setup Mode	Yes : Agree to setup mode No : Cancel to setup mode
Export Secure Boot variables	Copy NVRAM content of Secure Boot variables to files in a root folder on a file system device
Enroll Efi Image	Allow the image to run in Secure Boot mode
Remove 'UEFI CA' from DB	To remove 'UEFI CA' from database Yes : Agree to remove 'UEFI CA' from database No : Cancel to remove 'UEFI CA' from database
Restore DB defaults	Restore DB variables to factory defaults Yes : Agree to restore DB defaults No : Cancel to restore DB defaults

Item	Description
Platform Key (PK)	These items allows you to enroll factory defaults or load Certificates from a file.
Key Exchange Keys	
Authorized Signatures	
Forbidden Signatures	
Authorized TimeStamps	
OsRecovery Signatures	

3.6 Boot

This Boot menu allows you to set/change system boot options

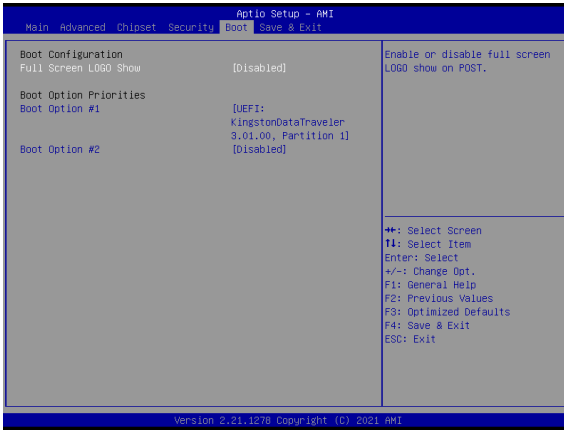

Item	Description
Full Screen LOGO Show	Enable/Disable full screen LOGO show on POST screen Enabled : Enables Full screen LOGO Show on POST screen Disabled : Disables Full screen LOGO Show on POST screen (Default setting)
Boot Option #1 Boot Option #2	Shows the information of the storage that be installed in the system Choose/set the boot priority

3.7 Save & Exit



Item	Description
Save Changes and Reset	After configuring all the options that you wish to change, choose this option to save all the changes and reboot the system Yes : Agree to save and reset No : Cancel to save and reset
Discard Changes and Reset	Choose this option to reboot the system without saving any changes Yes : Agree to discard changes and reset No : Cancel to discard changes and reset
Restore Defaults	Restore/Load default values for all the setup options Yes : Agree to load optimized defaults No : Cancel to load optimized defaults
Me FW Image Re-Flahs	Enable/Disable Me FW image re-flash function Enabled : Enables Me FW image re-flash function Disabled : Disables Me FW image re-flash function (Default setting)