

# IDS-200-A70M

- AMD® R-series Embedded System
- Four independent HDMI outputs

**New**

## Features

- ◆ High Definition AMD® R-series APU
- ◆ Four independent HDMI display video outputs
- ◆ Fanless design supporting 0°C ~ 50°C operating temperature
- ◆ SIM card support 3G/LTE wireless connection
- ◆ Support IPMI 2.0 via iRIS-2400 module



## New Intelligent Digital Signage Solution

### IEI iRIS Technology (IPMI 2.0 Compliant)

The IDS-200 is a next generation intelligent industrial digital signage system that supports four independent HDMI output displays. By installing the IEI IPMI 2.0 compliant iRIS-2400 module, the IDS-200 can benefit from the IPMI 2.0 features and allow system administrators to manage multiple systems remotely at the same time. The IDS-200 is capable to complete your IoT application through the advanced remote control features, such as power management and control, remote KVM for device status monitoring, sending active alerts and warning messages by e-mail or SMS.

#### Centralized control center:

In the control center, administrators can make remote diagnosis and remote OS installation without on-site visits. These great features can help users to increase system maintenance efficiency and reduce cost. Furthermore, administrators can install software remotely for the whole group, which can save your time and reduce maintenance cost significantly.

#### Remote management any time any where:

By installing the iRIS-2400 module, users can achieve remote management from a variety of devices, such as notebooks, mobile phones, tablets or any devices that can be linked to the Internet. With the real-time monitoring feature, users can monitor system health without on-site checking. The active alert message feature allows users to prepare appropriate prevention strategies to reduce security risk.

### ■ iRIS Remote Management Solution

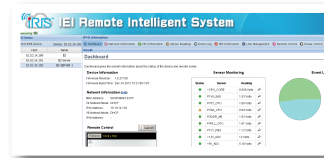

Group Management Apps

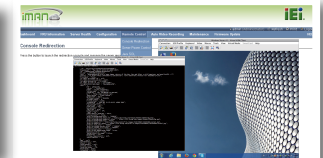

Web UI for Single Device

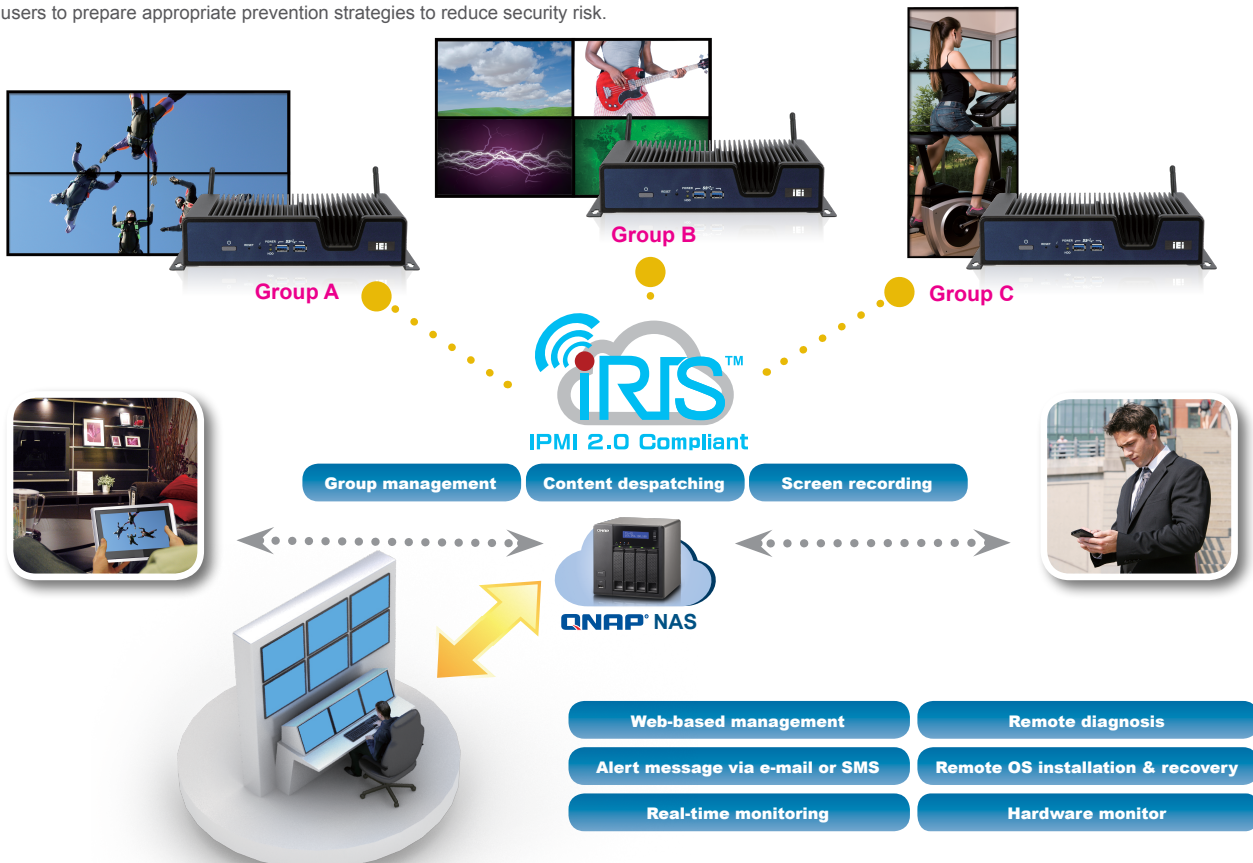



## A Variety of Video Output

The IDS-200 supports AMD's SLS (Single Large Surface) technology which allows four independent HDMI display outputs and a variety of video wall screen combinations. It is the best choice to implement in digital signage or video wall applications.

### ■ Four independent displays (2 x 2 screens) ■ Tiled display (2 x 2 screens) ■ Tiled display (1 x 4 screens)

Each screen Max. resolution 1920x1080



Max. resolution 3840x2160



Max. resolution 1920x4320



\*HDMI 2 and 4

When deploying 4 independent video outputs, the monitors connected to HDMI 2 and HDMI 4 connectors must be identical (with the same brand, model number and size).

## High Definition AMD® R-series APU

The AMD® Embedded R-series Accelerated Processing Unit (APU) combines AMD® high performance CPU technology and powerful AMD® Radeon graphics technology onto a single chip. The IDS-200 contains an R-260H APU, balanced with TDP 17W power and Radeon HD 7500G graphics. It is the best solution for graphics processing.

### ■ High Definition AMD® R-series APU

#### ◆ 3D Acceleration

- Full DirectX® 11 support, including full speed 32-bit floating point per component operations
- Shader Model 5
- OpenCL™ 1.1 support
- OpenGL 4.2 support

#### ◆ UVD 3.2 dedicated hardware video decoder

- H.264, MPEG4 Part 2, VC-1 and MPEG2 decode6
- Simultaneous dual HD source decode

#### ◆ VCE (Video Compression Engine) 1.0

- Hardware assisted encoding of HD video streams
- H.264 (baseline + CABAC) 1080p at 60 fps
- Real time transcoding

### ■ Target market of IDS-200



Entertainment

- ◆ Ultimate video solution Support up to 4 displays
- ◆ Great graphics processing Fulfill a variety of hardware decoder



Digital Signage



Gaming

Designed for high graphics performance

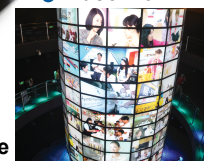

Video Wall

## S/PDIF Digital Audio Interconnect



S/PDIF is called "Sony/Philips Digital Interface Format". It is a digital audio output and its quality is much better than analog audio. S/PDIF is based on the professional AES3 interconnect standard. It is widely applied in Dolby Digital or DTS surround sound.



## Removable HDD/SSD Drive Bay

The IDS-200 has one easy-to-install HDD bay that supports 2.5" SATA 6Gb/s HDD.



## SD Card Supported

The IDS-200 contains an SD card slot, allowing users to install and change media contents easily.



www.ipc2u.ru

www.ipc2u.de

## SIM Card Supported

The IDS-200 has a SIM card slot for 3G/LTE wireless connection. Users can deploy the IDS-200 in outdoor environments for easy wireless data transmission.



www.sovio.com

Date:01.06.2016

## Specifications

Model Name		IDS-200-A70M
Chassis	Color	Black
	Dimensions (WxDxH) (mm)	251 x 173.35 x 57
	System Fan	Fanless
	Chassis Construction	Aluminum alloys
Motherboard	Processor CPU	AMD® R-series R-260H 2.1 GHz
	Chipset	AMD® A70M
	System Memory	2 x 204-pin DDR3 SO-DIMM 4GB pre-installed (system max: 16GB)
iRIS Module	iRIS Solution	iRIS-2400
Storage	Hard Drive	1 x 2.5" SATA 6Gb/s HDD/SSD drive bay
	SD Card	1
	mSATA	1 x mSATA (SATA 6Gb/s signal)
I/O Interfaces	USB 3.0	2
	USB 2.0	2
	Ethernet	2 x RJ-45 1 x PCIe GbE by Intel® I210 1 x PCIe GbE by Intel® I211
	RS-232	1 x RJ-45
	Display	4 x HDMI
	Resolution	1920 x 1080@60Hz
	Audio	1 x Line-out, 1 x S/PDIF
	Other	1 x SIM standard card slot
	Wireless	802.11b/g/n 2T2R (optional)
	Expansions	PCIe Mini
Power	Power Input	DC Jack: 10 V~30 V DC
	Power Consumption	19 V@1.78 A (AMD® R-260H with 4 GB memory)
Reliability	Mounting	Wall mount, VESA mount 75
	Operating Temperature	0°C ~ 50°C with air flow, 10% ~ 90%, non-condensing
	Operating Shock	Half-sine wave shock 5G, 11ms, 3 shocks per axis
	Operating Vibration	MIL-STD-810F 514.5C-2 (with SSD)
	Weight (Net/Gross)	5.24 kg/6.5 kg
	Safety/EMC	CE/FCC
OS	Supported OS	Microsoft® Windows® 8 Embedded, Microsoft® Windows® Embedded Standard 7 E

## Fully Integrated I/O

### Front View

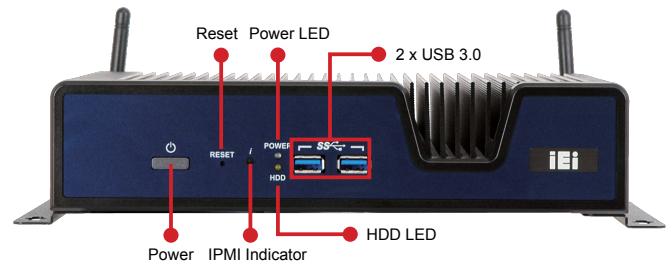

### Rear View

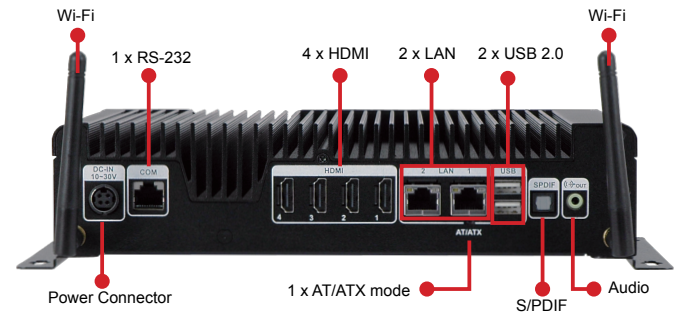

### Dimensions (Unit: mm)

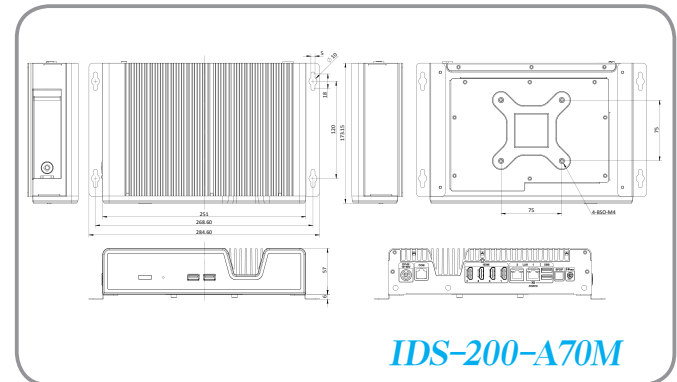

## Ordering information

Part No.	Description
IDS-200-A70Mi/4G-R10	Fanless embedded system, AMD® APU dual-core R260H 2.1 GHz, TDP 17W, 4GB DDR3 SO-DIMM (2 x 2GB) pre-installed, 4 x HDMI, iRIS-2400 optional, 10 V~30 V DC input, R10, RoHS

## Options

Item	Part No.	Description
OS: Windows Embedded 7 (CD-ROM)	IDS-200-WES7E-R10 (CD-ROM)	OS Image with Windows® Embedded Standard 7 E for IDS-200 Series, with CD-ROM, RoHS
iRIS module	iRIS-2400-R10	IPMI 2.0 adapter card with AST2400 BMC chip for DDR3 SO-DIMM socket interface
3G adaptor card	MPCIE-3G-R10	PCIe Mini 3G adaptor card, RoHS

## Packing list

Item	Part No.	Qty	Description
Power adapter	63040-010090-050-RS	1	Adapter Power, FSP, FSP090-D2BA1, 9NA0902808, Active PFC, Vin: 90 V AC~264 V AC, 90W, Dim: 51x129x30.9 mm, Plug=6.5MM, Cable=1500MM, ErP (no load 0.3W), Vout: 19 V DC, Din 4Pin/lock, CCL, RoHS
Wall mount kit	41020-0381C2-00-RS	1	WALL MOUNT BRACKET, MOUNTING BRACKET, NCT processing formation, IDS-200, PAINTING, PMS Black C, 41020-0381XX, NCT(N), SECC, VER: 00, CCL, RoHS
Power cord	32702-000401-100-RS	1	POWER CORD, EUROPEAN CODE (VDE), 2, 1500MM, (A)PLUG:SH005 (16 A 250 V), (B)CONNECTOR:SM112 (2.5 A 250 V), CABLE SPEC:H05VV-F 3C 0.75MM, Self-Man, CCL, RoHS
Utility CD		1	Drivers and user manual
Screw pack		1	IDS-200 screw pack