

DN-8237DB Data Sheet

(Version 1.1)

For Delta ASDA-A series Amplifier

1 DN-8237-DB Daughter Board

The DN-8237DB is the daughter board for Delta ASDA-A Series Amplifier. It has 2-axis I/O signals.

1.1 Board Layout for DN-8237-DB

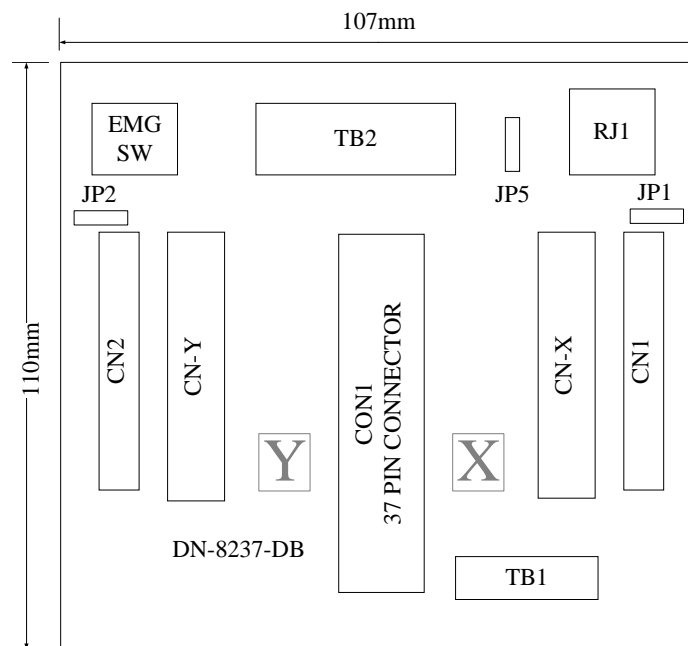

Fig. 1-1 Board layout for the DN-8237-DB

1.2 Signal Connections for DN-8237-DB

Maintaining signal connections is one of the most important factors in ensuring that your application system is sending and receiving data correctly.

■ Pin Assignment for CON1

The I/O connector on the DN-8237-DB is a 37-pin connector that enables you to connect to the PISO-PS200(or I-8092F) motion card. Fig. 1-2 shows the pin assignment for the 37-pin I/O connector on the DN-8237-DB (or on the motion card), and refer to Table 1-2 for description of each motion I/O signal.

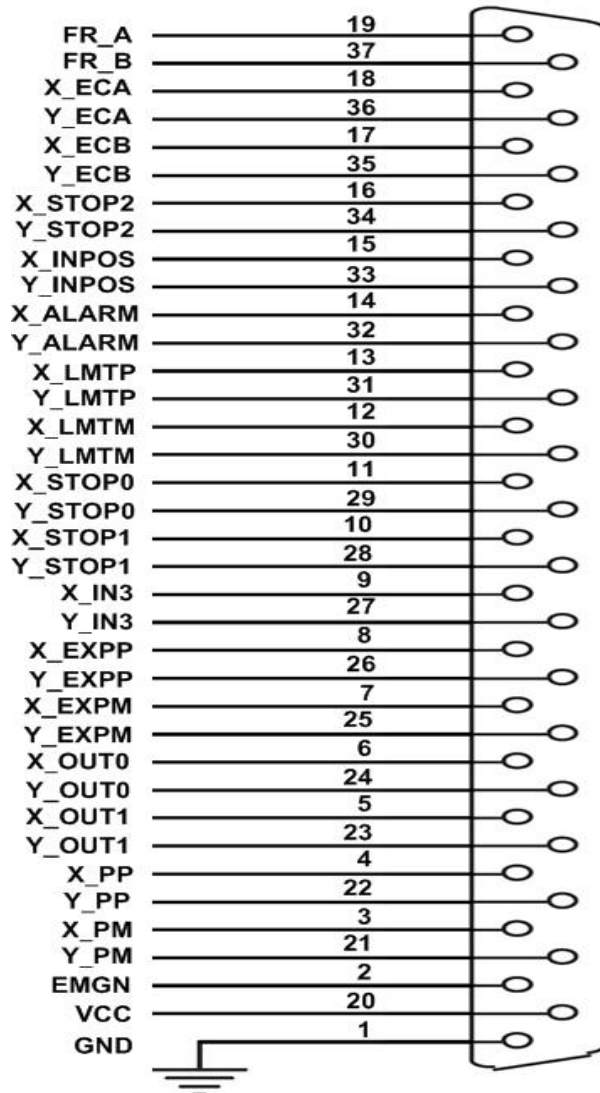

Fig. 1-2 I/O connector pin assignment for the CON1

Table 1-2 DN-8237-DB CON1 I/O connector signal description

Pin name	Pin number	Description
FR_A	19	FRnet A-phase signal
FR_B	37	FRnet B-phase signal
X_ECA	18	Encoder A-phase signal for the X axis
Y_ECA	36	Encoder A-phase signal for the Y axis
X_ECB	17	Encoder B-Phase signal for the X axis
Y_ECB	35	Encoder B-Phase signal for the Y axis
X_STOP2	16	Stop 2 signal for the X axis
Y_STOP2	34	Stop 2 signal for the Y axis
X_INPOS	15	In-position signal for the X axis
Y_INPOS	33	In-position signal for the Y axis
X_ALARM	14	Alarm signal for the X axis
Y_ALARM	32	Alarm signal for the Y axis
X_LMTP	13	Limit switch input signal (+) for the X axis
Y_LMTP	31	Limit switch input signal (+) for the Y axis
X_LMTM	12	Limit switch input signal (-) for the X axis
Y_LMTM	30	Limit switch input signal (-) for the Y axis
X_STOP0	11	Stop 0 signal for the X axis
Y_STOP0	29	Stop 0 signal for the Y axis
X_STOP1	10	Stop 1 signal for the X axis
Y_STOP1	28	Stop 1 signal for the Y axis
X_IN3	9	Input 3 signal for the X axis
Y_IN3	27	Input 3 signal for the Y axis
X_EXPP	8	EXT pulsar input signal (+) for the X axis
Y_EXPP	26	EXT pulsar input signal (+) for the Y axis
X_EXPM	7	EXT pulsar input signal (-) for the X axis
Y_EXPM	25	EXT pulsar input signal (-) for the Y axis
X_OUT0	6	Output 0 signal for the X axis
Y_OUT0	24	Output 0 signal for the Y axis
X_OUT1	5	Output 1 signal for the X axis
Y_OUT1	23	Output 1 signal for the Y axis
XPP	4	Driving pulsar signal (+) for the X axis
YPP	22	Driving pulsar signal (+) for the Y axis
XPM	3	Driving pulsar signal (+) for the X axis
YPM	21	Driving pulsar signal (+) for the Y axis
EMGN	2	Emergency stop input signal
VCC	20	Module power (+5V)
GND	1	Ground

■ TB1

The connector TB1 is 7-pin connector that enables you to connect to the signals of your motor drivers. Fig.1-3 shows the pin assignment for the 7-pin connector on the DN-8237-DB, and the Table 1-3 shows its I/O connector signal description.

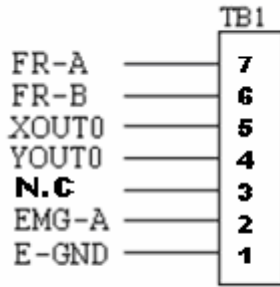

Fig. 1-3 Pin definition for TB1

Table 1-3 TB1 Signal Connection

Name	Description
FR-A	FRnet port A
FR-B	FRnet port B
XOUT0	General Output 0 for X axis
YOUT0	General Output 0 for Y axis
N.C	No Connection
EMG-A	EMG input signal for all axes
E-GND	EXT power ground

■ TB2

The connector TB2 is 5-pin connector that enables you to connect to the signals of your motor drivers. Fig.1-4 shows the pin assignment for the 5-pin connector on the DN-8237-DB, and the Table 1-4 shows its I/O connector signal description.

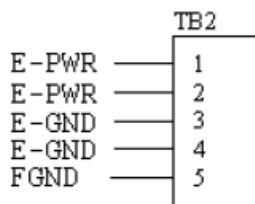

Fig. 1-4 Pin definition for TB2

Table 1-4 TB2 Signal Connection

Pin name	Description
E-PWR	EXT power supply +24V
E-GND	EXT power ground
FGND	Frame ground

► **Note:** Don't reverse connect signals with E_PWR and E_GND. Serious damage to your motion card and motion controller might be happened.

■ **CN-X & CN-Y (CN1 connector for each AXIS in Driver)**

The connectors CN-X and CN-Y are 50-pin connectors that enable you to connect to the CN1 connector of Delta ASDA-A series motor drivers. Fig.1-5 shows the pin assignment for the 50-pin connector on the DN-8468-DB, and the Table 1-5 shows its I/O connector signal description.

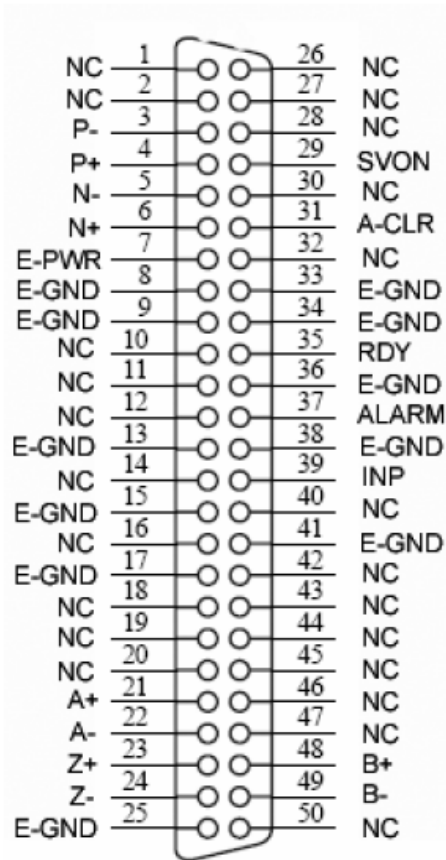

Fig. 1-5 Pin definition for CNX and CNY

Table 1-5 CN1 Signal Connection

Name	Number	Description
A+	21	Encoder A-Phase (+)
A-	22	Encoder A-Phase (-)
B+	48	Encoder B-Phase (+)
B-	49	Encoder B-Phase (-)
Z+	23	Encoder Z-Phase (+)
Z-	24	Encoder Z-Phase (-)
P+	4	Positive Direction Pulse Output(+)
P-	3	Positive Direction Pulse Output(-)
N+	6	Negative Direction Pulse
N-	5	Negative Direction Pulse Output(-)
INP	39	Servo In Position
RDY	35	Servo Ready
SVON	29	Servo On
A-CLR	31	Alarm Clear
ALARM	37	Servo Alarm
E-PWR	7	EXT power +24V
E-GND	8, 9, 13, 15,17, 25, 33,34, 36, 38,41	EXT power ground
NC	1,2,10,11, 12,14,16, 18,19,20, 26,27,28, 30,32,40, 42,43,44, 45,46,47, 50	No connection

► **Note 1:** Don't connect NC (not connected) signals. Connecting these signals could cause permanent damage to your motion controller.

■ CN1 & CN2 (The I/O signals of the X and Y AXIS)

The connectors CN1 and CN2 are 11-pin connectors that enable you to connect to the signals of your motor drivers. Fig.1-6 shows the pin assignment for the 20-pin connector on the DN-8237, and the Table 1-6 shows its I/O connector signal description.

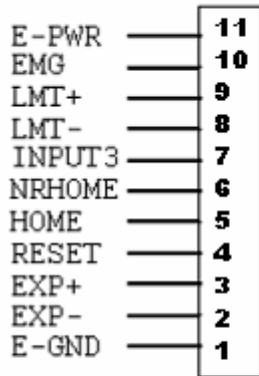

Fig. 1-6 Pin definition for CN1 & CN2

Table 1-6 CN1 & CN2 Signal Connection

Pin name	Description
E-PWR	EXT power supply +24V
EMG	EMG input signal
LMT+	Limit Switch Input Signal (+)
LMT-	Limit Switch Input Signal (-)
INPUT3	Input Signal (IN3)
NRHOME	Near Home Sensor Input Signal
HOME	Home Sensor Input Signal
RESET	Reset input signal
EXP+	EXT Positive Direction Pulse (+)
EXP-	EXT Negative Direction Pulse (-)
E-GND	EXT power ground

■ RJ1 (The I/O signals of the FRnet)

The connectors RJ1 is an 8-pin RJ45 connector that enable you to connect to the signals of FRnet. Fig.1-7 shows the pin assignment for the 8-pin connector on the DN-8237-DB, and the Table 1-7 shows its I/O connector signal description.

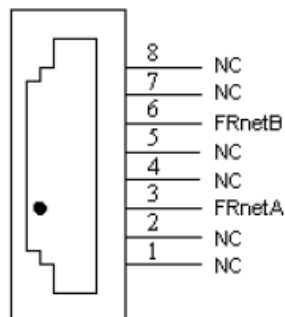

Fig. 1-7 Pin definition for RJ1

Table 1-7 RJ1

Pin name	Description
FRnetA	FRnet port A
FRnetB	FRnet port B
NC	No connection

► **Note:** Don't connect NC (not connected) signals. Connecting these signals could cause permanent damage to your motion controller.

1.3 Jumper and Switch Settings

■ JP5

Jumper 5 controls the EMG-A signal of the TB1 connector. The following diagram is shown the selection condition of the jumper 5.

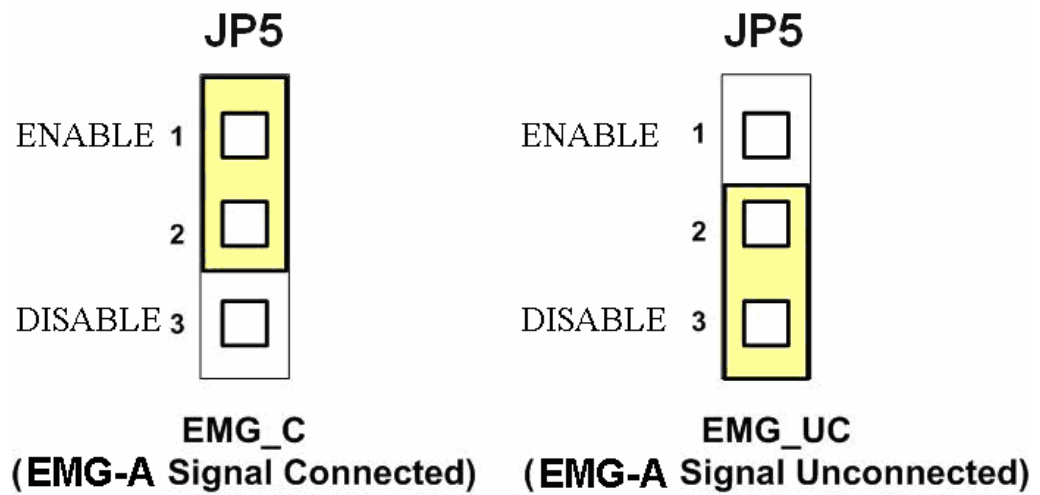

Fig. 1-8 Jumper 5 setting

■ SW 1

The emergency stop signal for each servo amplifier can be selected from SW1. The number 1 and 2 on SW1 are denoted as axis X and Y, respectively. The number 3 and 4 on SW1 are reserved for future work. Fig. 1-9 is the default setting to connect the EMG signals to GND. The EMG signals from CN1 and CN2 will not take effect. If the switch is disconnected as shown in Fig. 1-10, the emergency stop signals can be controlled from EMG signals in CN1 and CN2.

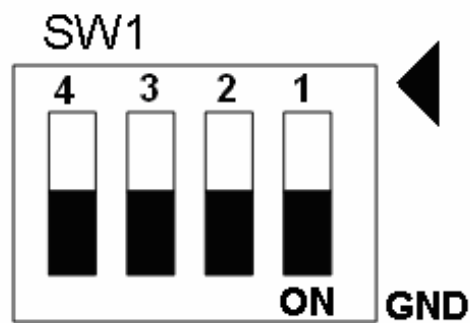

Fig. 1-9 SW1 setting for normally GND (Default setting)

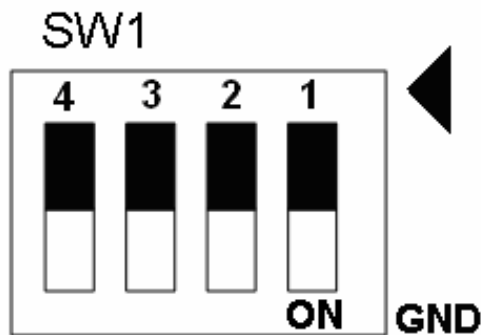

Fig. 1-10 SW1 setting for user controlled signals.

■ JP1 ~ JP2

Jumper 1 ~ Jumper 2 can select the reset function in CN1 and CN2 for each axis. The following diagram is shown the selection condition of the JP1.

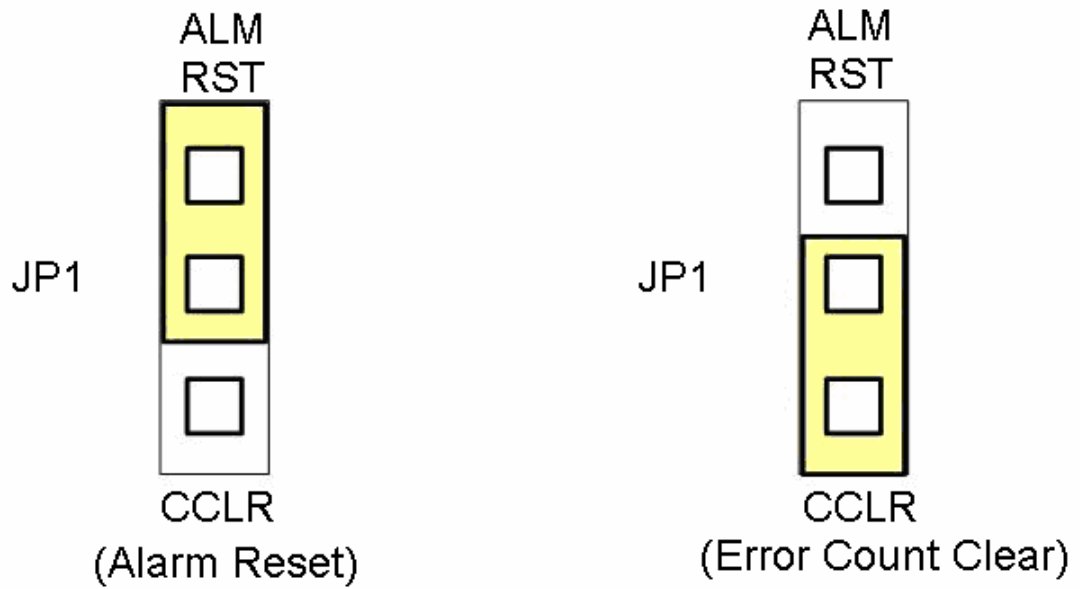

Fig. 1-15 JP 1 and 2 setting