



NEXCOM International Co., Ltd.

Intelligent Platform & Services Business Unit

Digital Signage Platform

NDiS B560

User Manual

Contents

Preface

Copyright	iv
Disclaimer	iv
Acknowledgements	iv
Regulatory Compliance Statements	iv
Declaration of Conformity	iv
RoHS Compliance	v
Warranty and RMA	vi
Safety Information	viii
Installation Recommendations	viii
Safety Precautions	ix
Technical Support and Assistance	x
Conventions Used in this Manual	x
Global Service Contact Information	xi
Package Contents	xiii
Ordering Information	xiv

Chapter 1: Product Introduction

Overview	1
Key Features	1
Physical Features	2
Front Panel	2
Rear Panel	2
Hardware Specifications	3
Mechanical Dimensions	5

Chapter 2: Jumpers and Connectors

Before You Begin	6
Precautions	6
Locations of the Jumpers and Connectors for NDiB B560	7
NDiB B560	7
Top View	7
Bottom View	8
Jumper Settings	9
Jumper and DIP Switch Settings	10
CMOS Clear Selection	10
AT/ATX Mode Selection	10
Connector Pin Definitions	11
External I/O Interfaces - Front Panel	11
Power Button	11
Power/HDD LED Connector	11
COM 1 Port	12
COM 2 Port	12
COM 3 Port	13
COM 4 Port	13
Connector location: COM4	13
USB3.1 Ports	14
Reset Connector	14
External I/O Interfaces - Rear Panel	15
USB 3.1 Ports	15
USB3.1 Ports	15
DC In Connector	16

HDMI1 Connector.....	16
HDMI2 Connector.....	17
HDMI3 Connector.....	17
LAN1 I219 Connector.....	18
LAN2 I210 Connector.....	18
Mic In (Pink) Connector.....	19
Audio Connector.....	19
Internal Connectors.....	20
Port 80 Connector.....	20
Fan1 Connector.....	20
Fan2 Connector.....	21
GPIO Connector.....	21
SATA Connector.....	22
SPEK Pin Header Connector.....	22
Reset/PUT Connector.....	23
DC In for NTK-B560-PW Connector.....	23
USB2.0 Pin Header Connector.....	24
USB2.0 Pin Header Connector.....	24
SMABUS Pin Header.....	25
RI Connector.....	25
Battery Connector.....	26
CON1 Connector.....	26
SIM Card Connector.....	27
NGFF Key E Connector.....	28
NGFF Key M Connector.....	29
NGFF Key B Connector.....	30
Block Diagram.....	31

Chapter 3: System Setup

Removing the Chassis Cover.....	32
Installing a CPU.....	34
Installing a SO-DIMM (DIMM2).....	37

Installing a SO-DIMM (DIMM1).....	38
Installing a HDD.....	39
Installing a M.2 Storage Module.....	41
(M-key 2280).....	41
Installing a M.2 WiFi Module.....	43
(E-key 2230).....	43
Assembling The Top Cover To The Chassis.....	45
Installing a M.2 LTE/5G module.....	47
(B-key 3042/3052) and SIM card.....	47

Chapter 4: BIOS Setup

About BIOS Setup.....	50
When to Configure the BIOS.....	50
Default Configuration.....	51
Entering Setup.....	51
Legends.....	51
BIOS Setup Utility.....	53
Main.....	53
Advanced.....	54
Chipset.....	69
PCH-IO Configuration.....	71
SATA And RST Configuration.....	71
HD Audio Configuration.....	72
EDID Mode Control.....	73
Security.....	73
Boot.....	74
Save & Exit.....	75

Preface

Copyright

This publication, including all photographs, illustrations and software, is protected under international copyright laws, with all rights reserved. No part of this manual may be reproduced, copied, translated or transmitted in any form or by any means without the prior written consent from NEXCOM International Co., Ltd.

Disclaimer

The information in this document is subject to change without prior notice and does not represent commitment from NEXCOM International Co., Ltd. However, users may update their knowledge of any product in use by constantly checking its manual posted on our website: <http://www.nexcom.com>. NEXCOM shall not be liable for direct, indirect, special, incidental, or consequential damages arising out of the use of any product, nor for any infringements upon the rights of third parties, which may result from such use. Any implied warranties of merchantability or fitness for any particular purpose is also disclaimed.

Acknowledgements

NDiS B560 is a trademark of NEXCOM International Co., Ltd. All other product names mentioned herein are registered trademarks of their respective owners.

Regulatory Compliance Statements

This section provides the FCC compliance statement for Class B devices and describes how to keep the system CE compliant.

Declaration of Conformity

FCC

This equipment has been tested and verified to comply with the limits for a Class B digital device, pursuant to Part 15 of FCC Rules. These limits are designed to provide reasonable protection against harmful interference when the equipment is operated in a commercial environment. This equipment generates, uses, and can radiate radio frequency energy and, if not installed and used in accordance with the instructions, may cause harmful interference to radio communications. Operation of this equipment in a residential area (domestic environment) is likely to cause harmful interference, in which case the user will be required to correct the interference (take adequate measures) at their own expense.

CE

The product(s) described in this manual complies with all applicable European Union (CE) directives if it has a CE marking. For computer systems to remain CE compliant, only CE-compliant parts may be used. Maintaining CE compliance also requires proper cable and cabling techniques.

RoHS Compliance



NEXCOM RoHS Environmental Policy and Status Update

NEXCOM is a global citizen for building the digital infrastructure. We are committed to providing green products and services, which are compliant with European Union RoHS (Restriction on Use of Hazardous Substance in Electronic Equipment) directive 2011/65/EU, to be your trusted green partner and to protect our environment.

RoHS restricts the use of Lead (Pb) < 0.1% or 1,000ppm, Mercury (Hg) < 0.1% or 1,000ppm, Cadmium (Cd) < 0.01% or 100ppm, Hexavalent Chromium (Cr6+) < 0.1% or 1,000ppm, Polybrominated biphenyls (PBB) < 0.1% or 1,000ppm, and Polybrominated diphenyl Ethers (PBDE) < 0.1% or 1,000ppm.

In order to meet the RoHS compliant directives, NEXCOM has established an engineering and manufacturing task force to implement the introduction of green products. The task force will ensure that we follow the standard NEXCOM development procedure and that all the new RoHS components and new manufacturing processes maintain the highest industry quality levels for which NEXCOM are renowned.

The model selection criteria will be based on market demand. Vendors and suppliers will ensure that all designed components will be RoHS compliant.

How to recognize NEXCOM RoHS Products?

For existing products where there are non-RoHS and RoHS versions, the suffix "(LF)" will be added to the compliant product name.

All new product models launched after January 2013 will be RoHS compliant. They will use the usual NEXCOM naming convention.

Warranty and RMA

NEXCOM Warranty Period

NEXCOM manufactures products that are new or equivalent to new in accordance with industry standard. NEXCOM warrants that products will be free from defect in material and workmanship for 2 years, beginning on the date of invoice by NEXCOM.

NEXCOM Return Merchandise Authorization (RMA)

- Customers shall enclose the “NEXCOM RMA Service Form” with the returned packages.
- Customers must collect all the information about the problems encountered and note anything abnormal or, print out any on-screen messages, and describe the problems on the “NEXCOM RMA Service Form” for the RMA number apply process.
- Customers can send back the faulty products with or without accessories (manuals, cable, etc.) and any components from the card, such as CPU and RAM. If the components were suspected as part of the problems, please note clearly which components are included. Otherwise, NEXCOM is not responsible for the devices/parts.
- Customers are responsible for the safe packaging of defective products, making sure it is durable enough to be resistant against further damage and deterioration during transportation. In case of damages occurred during transportation, the repair is treated as “Out of Warranty.”
- Any products returned by NEXCOM to other locations besides the customers’ site will bear an extra charge and will be billed to the customer.

Repair Service Charges for Out-of-Warranty Products

NEXCOM will charge for out-of-warranty products in two categories, one is basic diagnostic fee and another is component (product) fee.

System Level

- Component fee: NEXCOM will only charge for main components such as SMD chip, BGA chip, etc. Passive components will be repaired for free, ex: resistor, capacitor.
- Items will be replaced with NEXCOM products if the original one cannot be repaired. Ex: motherboard, power supply, etc.
- Replace with 3rd party products if needed.
- If RMA goods can not be repaired, NEXCOM will return it to the customer without any charge.

Board Level

- Component fee: NEXCOM will only charge for main components, such as SMD chip, BGA chip, etc. Passive components will be repaired for free, ex: resistors, capacitors.
- If RMA goods can not be repaired, NEXCOM will return it to the customer without any charge.

Warnings

Read and adhere to all warnings, cautions, and notices in this guide and the documentation supplied with the chassis, power supply, and accessory modules. If the instructions for the chassis and power supply are inconsistent with these instructions or the instructions for accessory modules, contact the supplier to find out how you can ensure that your computer meets safety and regulatory requirements.

Cautions

Electrostatic discharge (ESD) can damage system components. Do the described procedures only at an ESD workstation. If no such station is available, you can provide some ESD protection by wearing an antistatic wrist strap and attaching it to a metal part of the computer chassis.

Safety Information

Before installing and using the device, note the following precautions:

- Read all instructions carefully.
- Do not place the unit on an unstable surface, cart, or stand.
- Follow all warnings and cautions in this manual.
- When replacing parts, ensure that your service technician uses parts specified by the manufacturer.
- Avoid using the system near water, in direct sunlight, or near a heating device.
- The load of the system unit does not solely rely for support from the rackmounts located on the sides. Firm support from the bottom is highly necessary in order to provide balance stability.
- The computer is provided with a battery-powered real-time clock circuit. There is a danger of explosion if battery is incorrectly replaced. Replace only with the same or equivalent type recommended by the manufacturer. Discard used batteries according to the manufacturer's instructions.
- The instructions shall require connection of the equipment protective earthing conductor to the installation protective earthing conductor (for example, by means of a power cord connected to a socket-outlet with earthing connection).

Installation Recommendations

Ensure you have a stable, clean working environment. Dust and dirt can get into components and cause a malfunction. Use containers to keep small components separated.

Adequate lighting and proper tools can prevent you from accidentally damaging the internal components. Most of the procedures that follow require only a few simple tools, including the following:

- A Philips screwdriver
- A flat-tipped screwdriver
- A grounding strap
- An anti-static pad

Using your fingers can disconnect most of the connections. It is recommended that you do not use needle-nose pliers to disconnect connections as these can damage the soft metal or plastic parts of the connectors.

Safety Precautions

1. Read these safety instructions carefully.
2. Keep this User Manual for later reference.
3. Disconnect this equipment from any AC outlet before cleaning. Use a damp cloth. Do not use liquid or spray detergents for cleaning.
4. For plug-in equipment, the power outlet socket must be located near the equipment and must be easily accessible.
5. Keep this equipment away from humidity.
6. Put this equipment on a stable surface during installation. Dropping it or letting it fall may cause damage.
7. The openings on the enclosure are for air convection to protect the equipment from overheating. **DO NOT COVER THE OPENINGS.**
8. Make sure the voltage of the power source is correct before connecting the equipment to the power outlet.
9. Place the power cord in a way so that people will not step on it. Do not place anything on top of the power cord. Use a power cord that has been approved for use with the product and that it matches the voltage and current marked on the product's electrical range label. The voltage and current rating of the cord must be greater than the voltage and current rating marked on the product.
10. All cautions and warnings on the equipment should be noted.
11. If the equipment is not used for a long time, disconnect it from the power source to avoid damage by transient overvoltage.
12. Never pour any liquid into an opening. This may cause fire or electrical shock.
13. This equipment is not suitable for use in locations where children are likely to be present.
14. Never open the equipment. For safety reasons, the equipment should be opened only by qualified service personnel.
15. If one of the following situations arises, get the equipment checked by service personnel:
 - a. The power cord or plug is damaged.
 - b. Liquid has penetrated into the equipment.
 - c. The equipment has been exposed to moisture.
 - d. The equipment does not work well, or you cannot get it to work according to the user's manual.
 - e. The equipment has been dropped and damaged.
 - f. The equipment has obvious signs of breakage.
16. Do not place heavy objects on the equipment.
17. The unit uses a three-wire ground cable which is equipped with a third pin to ground the unit and prevent electric shock. Do not defeat the purpose of this pin. If your outlet does not support this kind of plug, contact your electrician to replace your obsolete outlet.
18. **ATTENTION: Risque d'explosion si la batterie est remplacée par un type incorrect. Mettre au rebus les batteries usagées selon les instructions.**

CAUTION: Risk of explosion if battery is replaced by an incorrect type. Dispose of used batteries according to the instructions.
19. This product is intended to be supplied by a Listed (Certificate) power adapter, output rated 12Vdc, 8A or 8.33A minimum, Tma 40 degree C minimum and altitude 2000m. If further assistance is needed, please contact NEXCOM for further information.

Technical Support and Assistance

1. For the most updated information of NEXCOM products, visit NEXCOM's website at www.nexcom.com.
2. For technical issues that require contacting our technical support team or sales representative, please have the following information ready before calling:
 - Product name and serial number
 - Detailed information of the peripheral devices
 - Detailed information of the installed software (operating system, version, application software, etc.)
 - A complete description of the problem
 - The exact wordings of the error messages

Warning!

1. Handling the unit: carry the unit with both hands and handle it with care.
2. Maintenance: to keep the unit clean, use only approved cleaning products or clean with a dry cloth.
3. CompactFlash: Turn off the unit's power before inserting or removing a CompactFlash storage card.

Conventions Used in this Manual



Warning:

Information about certain situations, which if not observed, can cause personal injury. This will prevent injury to yourself when performing a task.



Caution:

Information to avoid damaging components or losing data.



Note:

Provides additional information to complete a task easily.

Global Service Contact Information

Headquarters

NEXCOM International Co., Ltd.

9F, No. 920, Chung-Cheng Rd.,
Zhonghe District, New Taipei City, 23586,
Taiwan, R.O.C.
Tel: +886-2-8226-7786
Fax: +886-2-8226-7782
www.nexcom.com

Asia

Taiwan

NexAIoT Headquarters

Industry 4.0 and Cloud Services

13F, No.916, Zhongzheng Rd.,
Zhonghe District, New Taipei City,
23586, Taiwan, R.O.C.
Tel: +886-2-8226-7796
Fax: +886-2-8226-7926
Email: sales@nexaiot.com
www.nexaiot.com

NexAIoT Co., Ltd.

Taichung Office

16F, No.250, Sec. 2, Chongde Rd.,
Beitun District,
Taichung City, 406, Taiwan, R.O.C.
Tel: +886-4-2249-1179
Fax: +886-4-2249-1172
Email: sales@nexaiot.com
www.nexaiot.com

NexCOBOT Taiwan Co., Ltd.

13F, No.916, Chung-Cheng Rd.,
Zhonghe District,
New Taipei City, 23586, Taiwan, R.O.C.
Tel: +886-2-8226-7786
Fax: +886-2-8226-7926
Email: sales@nexcobot.com
www.nexcobot.com

GreenBase Technology Corp.

13F, No.922, Chung-Cheng Rd.,
Zhonghe District,
New Taipei City, 23586, Taiwan, R.O.C.
Tel: +886-2-8226-7786
Fax: +886-2-8226-7900
Email: sales@nexcom.com.tw
www.nexcom.com.tw

EMBUX Technology Co., Ltd.

13F, No.916, Chung-Cheng Rd.,
Zhonghe District,
New Taipei City, 23586, Taiwan, R.O.C.
Tel: +886-2-8226-7786
Fax: +886-2-8226-7782
Email: sales@nexcom.com.tw
www.nexcom.com.tw

TMR Technology Corp.

13F, No.916, Chung-Cheng Rd.,
Zhonghe District,
New Taipei City, 23586, Taiwan, R.O.C.
Tel: +886-2-8226-7786
Fax: +886-2-8226-7782
Email: sales@nexcom.com.tw
www.nexcom.com.tw

China

NEXSEC Incorporated

5F, No.4, No.7 Fengxian Middle Rd.,
(Beike Industrial Park), Haidian District,
Beijing, 100094, China
Tel: +86-10-5704-2680
Fax: +86-10-5704-2681
Email: marketing@nexsec.cn
www.nexsec.cn

NEXCOM Shanghai

No.4, 16 Building,
Shanghai OMNI Tech & Science Park
No. 1699, Douhui Rd.,
Shanghai, 201108, China
Tel: +86-21-5278-5868
Fax: +86-21-3251-6358
Email: sales@nexcom.cn
www.nexcom.cn

NEXCOM Surveillance Technology Corp.

5F, Building C, ZhenHan Industrial Zone,
GanKeng Community, Buji Street,
LongGang District,
ShenZhen, 518112, China
Tel: +86-755-8364-7768
Fax: +86-755-8364-7738
Email: steveyang@nexcom.com.tw
www.nexcom.cn

NEXCOM United System Service

Room 603/604, Huiyinmingzun Plaza Bldg. 1,
No. 609, Yunlin East Rd.,
Shanghai, 200062, China
Tel: +86-21-5278-5868
Fax: +86-21-3251-6358
Email: renwang@nexcom.com.tw
www.nexcom.cn

NEXGOL Chongqing

1F, Building B4, Electronic 2nd Area,
(Phoenix Lake Industrial Park), Yongchuan Dist.,
Chongqing City, 402160, China
Tel: +86-23-4960-9080
Fax: +86-23-4966-5855
Email: sales@nexgol.com.cn
www.nexcobot.com/NexGOL

NexCOBOT China

Room 501, Building 1, Haichuang Building,
No.7 Qingyi Road, Guicheng Street,
Nanhai District, Foshan City,
Guangdong Province, 528314, China
Tel: +86-757-8625-7118
Email: sales@nexcobot.com
www.nexcobot.com.cn

Beijing NexGemo Technology Co.,Ltd.

5F, Gemotech Building, No.1, Development Rd.,
Changping International Information Industry Base,
Changping District,
Beijing, 102206, China
Tel: +86-10-8190-9328
Fax: +86-10-8190-9456
Email: sales@gemotech.cn
www.nexgemo.cn

Japan

NEXCOM Japan

9F, Tamachi Hara Bldg.,
4-11-5, Shiba Minato-ku,
Tokyo, 108-0014, Japan
Tel: +81-3-5419-7830
Fax: +81-3-5419-7832
Email: sales@nexcom-jp.com
www.nexcom-jp.com

America

USA NEXCOM USA

46665 Fremont Blvd.,
Fremont CA 94538, USA
Tel: +1-510-656-2248
Fax: +1-510-656-2158
Email: sales@nexcom.com
www.nexcomusa.com

Europe

United Kingdom NEXCOM EUROPE

10 Vincent Avenue,
Crownhill Business Centre,
Milton Keynes, Buckinghamshire
MK8 0AB, United Kingdom
Tel: +44-1908-267121
Fax: +44-1908-262042
Email: sales.uk@nexcom.eu
www.nexcom.co.uk

Package Contents

Before continuing, verify that the NDiS B560 package that you received is complete. Your package should have all the items listed in the following table.

Item	Part Number	Name	Qty
1	19W00B56000X0	NDiS B560 System	1
2	5060200082X00	Thermal Pad NDiS B533 VER:A EAPUS 25x25x0.2mm (for CPU)	1
3	5060200531X00	Thermal Pad E-LIN 50x25x1.0mm K=4.2W/mk PK404 (for M.2)	1
4	5060200579X00	Thermal Pad E-LIN 50x25x2mm K=4.2 W/mk PK404+9448 (for M.2)	1
5	5060200307X00	Thermal Pad For NDiS B426 Heat Sink E-LIN 60x20x1mm S3S (form memory)	1
6	5040420101X00	NDiS B535 HDD Bracket VER:A JAN YU 8x10.4x95mm SPCC NI	2
7	50311F0326X00	Flat Head Screw Long Fei:F3x5 Nylok Ni+Heat Treatment (for HDD Bracket)	4
8	5040430540X00	Wall Mount Bracket for NDiS B560 Series VER:A SHYUNG SHUHN 37.05x190x6.6mm SGCC Nickel Plated	2
9	50311F0100X00	(H)Round Head Screw w/Spring+Flat Washer Long Fei:P3x6L P3x6 iso/SW6x0.5 NI (for Wall Mount Bracket)	8
10	7400096007X00	Power adapter FSP:FSP096-AHAN3 96W 12V/8A	1

Ordering Information

The following information below provides ordering information for NDiS B560.

NDiS B560 (P/N: 10W00B56000X0)

- 9th and 8th generation Intel® Core™ processor (up to 35W) fanless system
- Intel® Q370 chipset

Chapter 1: Product Introduction

Overview



Powered by the 9th and 8th generation Intel® Core™ processor series and Intel® 300 Series chipset integrated graphics controller, the NDiS B560 fanless embedded player can handle powerful multimedia content. In addition, the NDiS B560 can be operated in an extended operating temperature range between -20 to 60°C, with three 4K2K independent display output and rich connectives including Wi-Fi and 4G, 5G support. The NDiS B560 can fully satisfy customer's expectation and therefore, be used in both indoor and outdoor applications such as DOOH, hospitality, brand promotion, digital menu board, outdoor bus station and even smart stadium.

Key Features

- Support 8th and 9th Generation Intel® Core™ i9/i7/i5/i3 LGA socket type embedded processor, up to 35W
- Intel® Q370
- Intel® integrated UHD 630 graphic engine
- Support 3 independent 4K2K 60Hz display output
- Support 1 x 2.5" SATA HDD
- HDMI 2.0 x3, USB 3.0 x6, GbE LAN x2, COM x4, Line-out x1, Mic-in x1
- Support M.2 Key B/E/M
- Fanless design
- Support a wide temperature range of -20 to 60°C

Physical Features

Front Panel

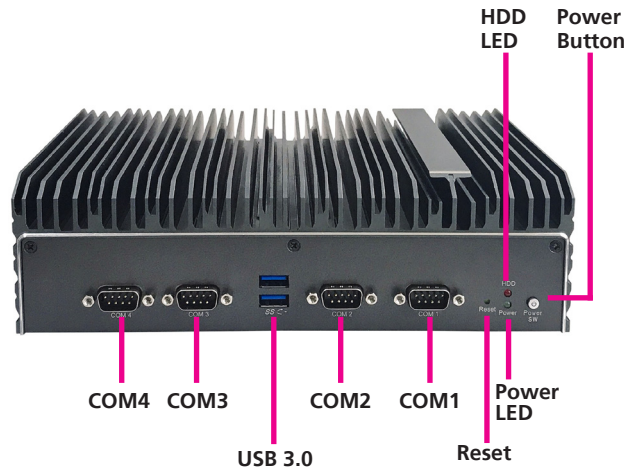

Rear Panel

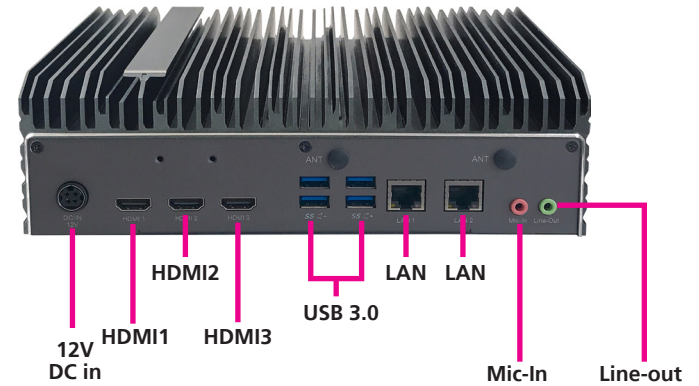

Hardware Specifications

CPU Support

- 8th and 9th generation Intel® Core™ i9/i7/i5/i3 LGA socket type processor, up to 35W
 - Core™ i9-9900T, 8 Core, 2.1GHz, 16M Cache (0~40°C)
 - Core™ i7-9700TE, 8 Core, 1.8GHz, 12M Cache
 - Core™ i5-9500TE, 6 Core, 2.2GHz, 9M Cache
 - Core™ i3-9100TE, 4 Core, 2.2GHz, 6M Cache
 - Core™ i7-8700T, 6 Core, 2.4GHz, 12M Cache
 - Core™ i5-8500T, 6 Core, 2.1GHz, 9M Cache
 - Core™ i3-8100T, 4 Core, 3.1GHz, 6M Cache

Chipset

- Intel® PCH Q370
- Intel® UHD graphics 630 series

Main Memory

- 2x 260-pin SO-DIMM sockets, supports DDR4 2666MHz non-ECC, unbuffered memory up to 32GB (single socket max. 16GB)

I/O Interface-Front

- 1x Power status LED
- 1x HDD status LED
- 1x Power button with LED
- 1x Reset switch
- 2x USB 3.0
- 4x DB9 for COM1~COM4
 - COM1: RS232/422/485
 - COM2~4: RS232
- 2 x Antenna hole

I/O Interface-Rear

- +12V DC-in
- 3x HDMI 2.0
- 4x USB3.0
- 2x RJ45 with LED for 10/100/1000Mbps Ethernet
- 1x Mic-in/ 1x Line-out
- 2x Antenna hole

I/O Interface-Internal

- 8CH GPIO support 4x GPO and 4x GPI
- Onboard TPM 2.0 (by request)
- Support iAMT

Storage

- 1x SATA 2.5" HDD/SSD
- 1x M.2 2280 (SATA, PCIe x4)/2242 (by request) Key M socket

Expansion

- 1x M.2 2230 Key E (PCIe x2), support optional Wi-Fi modules
- 1x M.2 3042/3052 Key B (SATA, USB 3.0), support optional 3G, 4G or 5G modules
- 1x SIM slot

Dimensions

- 238 mm (W) x 192 mm (D) x 67.29 mm(H) (9.4" x 7.6" x 2.6")

Power Supply

- 1x External 96W AC/ DC power adapter
Input: 100~240VAC
Output: DC+12VDC

Environment

- Operating temperature: -20°C to 60°C
- Storage temperature: -20°C to 80°C
- Humidity: 10 to 90% (non-condensing)

Certification

- CE approval
- FCC Class A

Operating System

- Windows 10/Linux

Chapter 2: Jumpers and Connectors

This chapter describes how to set the jumpers and connectors on the NDiS B560 motherboard.

Before You Begin

- Ensure you have a stable, clean working environment. Dust and dirt can get into components and cause a malfunction. Use containers to keep small components separated.
- Adequate lighting and proper tools can prevent you from accidentally damaging the internal components. Most of the procedures that follow require only a few simple tools, including the following:
 - A Philips screwdriver
 - A flat-tipped screwdriver
 - A set of jewelers screwdrivers
 - A grounding strap
 - An anti-static pad
- Using your fingers can disconnect most of the connections. It is recommended that you do not use needle-nosed pliers to disconnect connections as these can damage the soft metal or plastic parts of the connectors.
- Before working on internal components, make sure that the power is off. Ground yourself before touching any internal components, by touching a metal object. Static electricity can damage many of the electronic components. Humid environments tend to have less static electricity than

dry environments. A grounding strap is warranted whenever danger of static electricity exists.

Precautions

Computer components and electronic circuit boards can be damaged by discharges of static electricity. Working on computers that are still connected to a power supply can be extremely dangerous.

Follow the guidelines below to avoid damage to your computer or yourself:

- Always disconnect the unit from the power outlet whenever you are working inside the case.
- If possible, wear a grounded wrist strap when you are working inside the computer case. Alternatively, discharge any static electricity by touching the bare metal chassis of the unit case, or the bare metal body of any other grounded appliance.
- Hold electronic circuit boards by the edges only. Do not touch the components on the board unless it is necessary to do so. Don't flex or stress the circuit board.
- Leave all components inside the static-proof packaging that they shipped with until they are ready for installation.
- Use correct screws and do not over tighten screws.

Locations of the Jumpers and Connectors for NDiB B560

NDiB B560

The following figure are the top and bottom view of the NDiB B560, which is the main board used in the NDiS B560. It shows the locations of the jumpers and connectors.

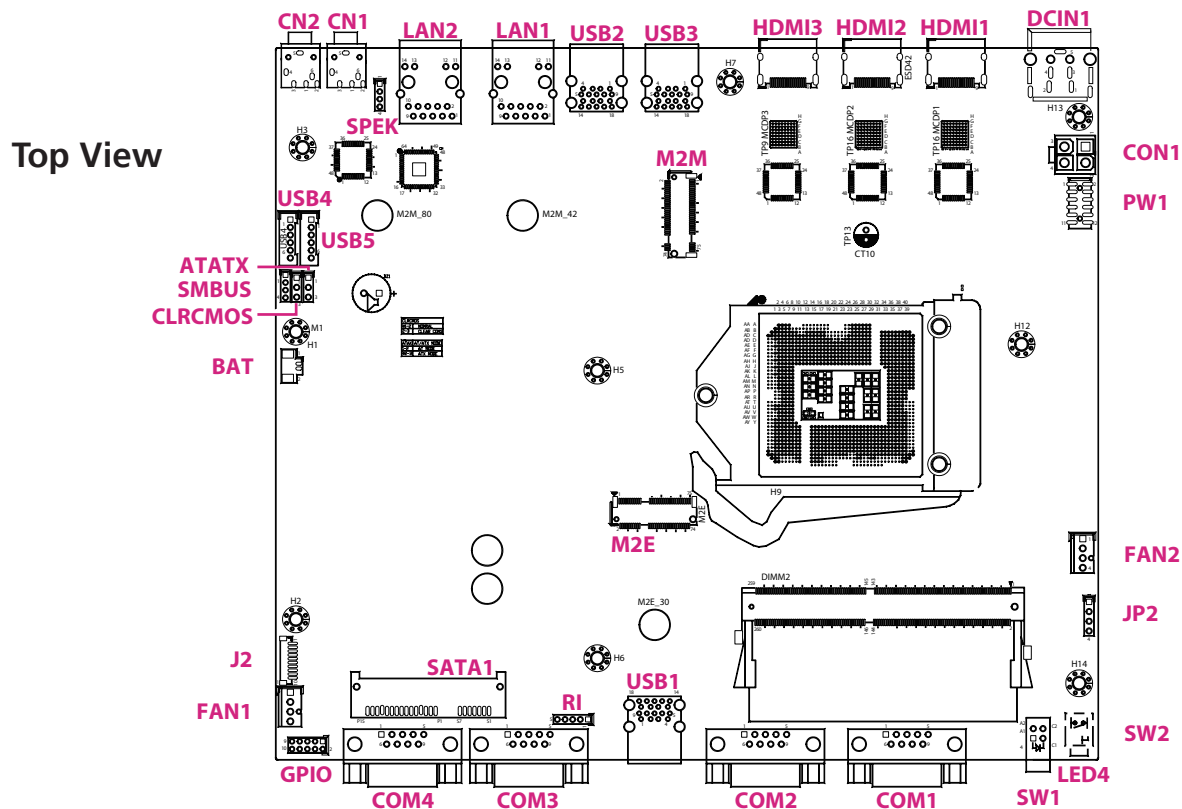

Bottom View

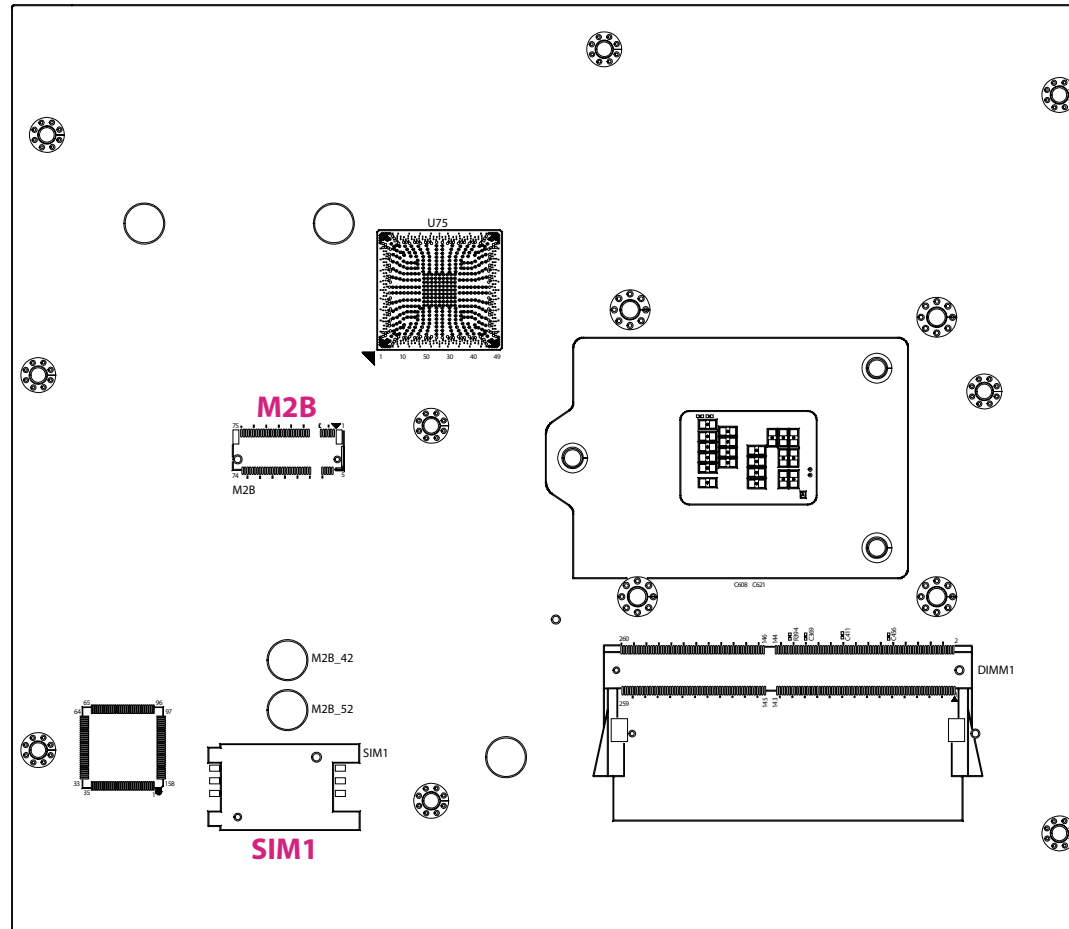

Jumper Settings

A jumper is the simplest kind of electric switch. It consists of two metal pins and a cap. When setting the jumpers, ensure that the jumper caps are placed on the correct pins. When the jumper cap is placed on both pins, the jumper is short. If you remove the jumper cap, or place the jumper cap on just one pin, the jumper is open.

Refer to the illustrations below for examples of what the 2-pin and 3-pin jumpers look like when they are short (on) and open (off).

Two-Pin Jumpers: Open (Left) and Short (Right)

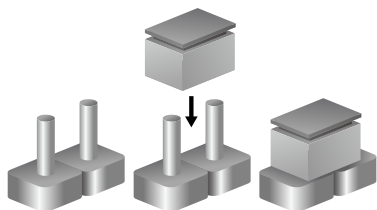

Three-Pin Jumpers: Pins 1 and 2 are Short

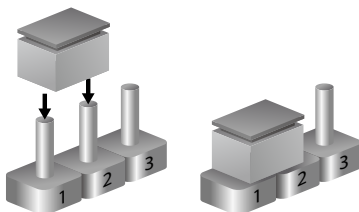

Jumper and DIP Switch Settings

CMOS Clear Selection

Connector type: 1x3 3-pin header

Connector location: CLRCMOS



Pin	Definition
1	NC
2	S_RTCRST#
3	DND

CLRCMOS	
1-2 On	Normal
2-3 On	Clear CMOS

1-2 On: default

AT/ATX Mode Selection

Connector type: 1x3 3-pin header, 2.54mm pitch

Connector location: ATATX



Pin	Definition
1	ATX_AT
2	S_PWRBTN#
3	PBT_SW

ATATX	AT/ATX Mode
1-2 On	AT Mode
2-3 On	ATX Mode

2-3 On: default

Connector Pin Definitions

External I/O Interfaces - Front Panel

Power Button

Connector location: SW2

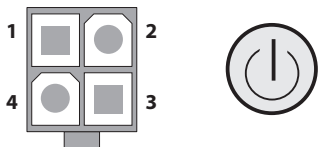

Pin	Definition	Pin	Definition
1	GND	2	H_PWRBTN#_M
3	H_PWRBTN#_M	4	GND
A1	PWRLED_N	C1	PWRLED_P
MH1		HM2	

Power	LED Definition
ON	Blue
OFF	Red

Power/HDD LED Connector

Connector location: LED4

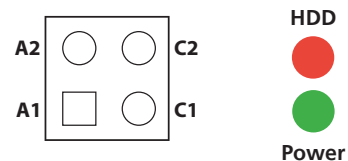

Pin	Definition	Pin	Definition
A1	POWER_LED	C1	LED_PWRN
A2	HD_LED	C2	HD_LEDN

LEDs	LED Definition
HDD	Red
Power	Green

COM 1 Port

Connector location: COM1

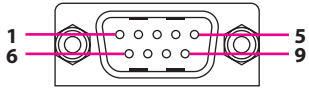

RS232			
Pin	Definition	Pin	Definition
1	COM1DCDL	2	COM1RXD
3	COM1TXD	4	COM1DTRL
5	GND	6	COM1DSRL
7	COM1RTSL	8	COM1CTSL
9	COM1RIL		
MH1	Front_GND	MH2	Front_GND
RS422			
1	COM1DCDL	2	COM1RXD
3	COM1TXD	4	COM1DTRL
MH1	FRONT_GND	MH2	FRONT_GND
RS485			
1	COM1DCDL	2	COM1RXD
MH1	FRONT_GND	MH2	FRONT_GND

COM 2 Port

Connector location: COM2

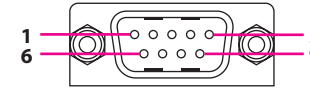

Pin	Definition	Pin	Definition
1	COM2DCDL	2	COM2RXD
3	COM2TXD	4	COM2DTRL
5	GND	6	COM2DSRL
7	COM2RTSL	8	COM2CTSL
9	COM2RIL		
MH1	Front_GND	MH2	Front_GND

COM 3 Port

Connector location: COM3

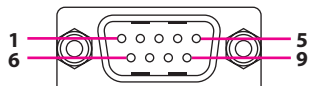

Pin	Definition	Pin	Definition
1	COM3DCDL	2	COM3RXD
3	COM3TXD	4	COM3DTRL
5	GND	6	COM3DSRL
7	COM3RTSL	8	COM3CTSL
9	RI_VCC12_VCC5		
MH1	Front_GND	MH2	Front_GND

COM 4 Port

Connector location: COM4

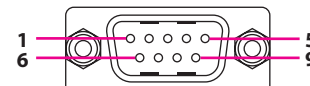

Pin	Definition	Pin	Definition
1	COM4DCDL	2	COM4RXD
3	COM4TXD	4	COM4DTRL
5	GND	6	COM4DSRL
7	COM4RTSL	8	COM4CTSL
9	COM4RIL		
MH1	Front_GND	MH2	Front_GND

USB3.1 Ports

Connector type: Dual USB 3.1 ports (NDiS B560S only USB2.0)

Connector location: USB1

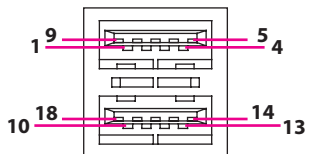

Pin	Definition	Pin	Definition
1	5VUSB1	2	USB2N_5
3	USB2P_5	4	GND
5	S_USB31_RXN5	6	S_USB31_RXP5
7	GND	8	USB31_TXN5
9	USB31_TXP5	10	5VUSB1
11	USB2N_6	12	USB2P_6
13	GND	14	S_USB31_RXN6
15	S_USB31_RXP6	16	GND
17	USB31_TXN6	18	USB31_TXP6
MH1	FRONT_GND	MH2	FRONT_GND
MH3	FRONT_GND	MH4	FRONT_GND

Reset Connector

Connector type: 1x2 2-pin header, 3.85mm pitch

Connector location: SW1



Pin	Definition
1	PM_RESET#_J
2	GND

External I/O Interfaces - Rear Panel

USB 3.1 Ports

Connector type: Dual 3.1 ports

Connector location: USB2

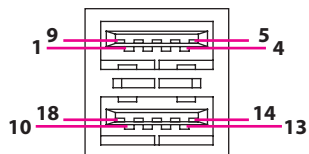

Pin	Definition	Pin	Definition
1	5VUSB4	2	USB2N_3
3	USB2P_3	4	GND
5	S_USB31_RXN3	6	S_USB31_RXP3
7	GND	8	USB31_TXN3
9	USB31_TXP3	10	5VUSB4
11	USB2N_4	12	USB2P_4
13	GND	14	S_USB31_RXN4
15	S_USB31_RXP4	16	GND
17	USB31_TXN4	18	USB31_TXP4
MH1	REAR_GND	MH2	REAR_GND
MH3	REAR_GND	MH4	REAR_GND

USB3.1 Ports

Connector type: Dual USB 3.1 ports

Connector location: USB3

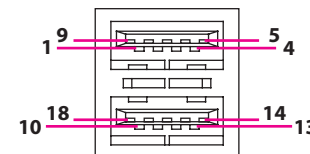

Pin	Definition	Pin	Definition
1	5VUSB3	2	USB2N_1
3	USB2P_1	4	GND
5	S_USB31_RXN1	6	S_USB31_RXP1
7	GND	8	USB31_TXN1
9	USB31_TXP1	10	5VUSB3
11	USB2N_2	12	USB2P_2
13	GND	14	S_USB31_RXN2
15	S_USB31_RXP2	16	GND
17	USB31_TXN2	18	USB31_TXP2
MH1	REAR_GND	MH2	REAR_GND
MH3	REAR_GND	MH4	REAR_GND

DC In Connector

Connector location: DCIN1

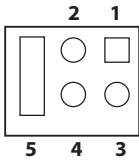

Pin	Definition	Pin	Definition
1	12VSB	2	12VSB
3	GND	4	GND
5	GND	MH1	REAR_GND
MH2	REAR_H_GND	MH3	REAR_H_GND
MH4	REAR_GND		

HDMI1 Connector

Connector type: HDMI port

Connector location: HDMI1

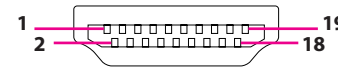

Pin	Definition	Pin	Definition
1	HDMI1_TX2_P_CN	2	GND
3	HDMI1_TX2_N_CN	4	HDMI1_TX1_P_CN
5	GND	6	HDMI1_TX1_N_CN
7	HDMI1_TX0_P_CN	8	GND
9	HDMI1_TX0_N_CN	10	HDMI1_CLK_P_CN
11	GND	12	HDMI1_CLK_N_CN
13	HDMI1_CEC	14	NC
15	HDMI1_SCL	16	HDMI1_SDA
17	GND	18	HDMI1_PWR_C
19	HDMI1_HPD_C	MH1	REAR_GND
MH2	REAR_GND	MH3	REAR_GND
MH4	REAR_GND		

HDMI2 Connector

Connector type: HDMI port
Connector location: HDMI2

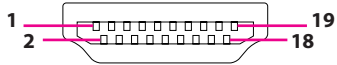

Pin	Definition	Pin	Definition
1	HDMI2_TX2_P_CN	2	GND
3	HDMI2_TX2_N_CN	4	HDMI2_TX1_P_CN
5	GND	6	HDMI2_TX1_N_CN
7	HDMI2_TX0_P_CN	8	GND
9	HDMI2_TX0_N_CN	10	HDMI2_CLK_P_CN
11	GND	12	HDMI2_CLK_N_CN
13	HDMI2_CEC	14	NC
15	HDMI2_SCL	16	HDMI2_SDA
17	GND	18	HDMI2_PWR_C
19	HDMI2_HPD_C	MH1	REAR_GND
MH2	REAR_GND	MH3	REAR_GND
MH4	REAR_GND		

HDMI3 Connector

Connector type: HDMI port (NDiS B560-Q370 Only)
Connector location: HDMI3

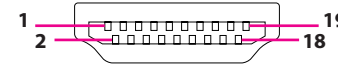

Pin	Definition	Pin	Definition
1	HDMI3_TX2_P_CN	2	GND
3	HDMI3_TX2_N_CN	4	HDMI3_TX1_P_CN
5	GND	6	HDMI3_TX1_N_CN
7	HDMI3_TX0_P_CN	8	GND
9	HDMI3_TX0_N_CN	10	HDMI3_CLK_P_CN
11	GND	12	HDMI3_CLK_N_CN
13	HDMI3_CEC	14	NC
15	HDMI3_SCL	16	HDMI3_SDA
17	GND	18	HDMI3_PWR_C
19	HDMI3_HPD_C	MH1	REAR_GND
MH2	REAR_GND	MH3	REAR_GND
MH4	REAR_GND		

LAN1 I219 Connector

Connector type: HDMI port

Connector location: LAN1

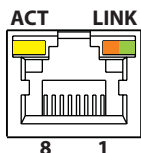

Act	Status
Flashing Yellow	Connected
Flashing Yellow	Data activity
Off	No activity

Link	Status
Steady Green	1G network link
Steady Orange	100Mbps network link
Off	10Mbps or no link

LAN2 I210 Connector

Connector type: HDMI port

Connector location: LAN2

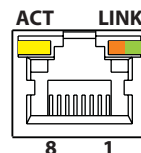

Act	Status
Flashing Yellow	Connected
Flashing Yellow	Data activity
Off	No activity

Link	Status
Steady Green	1G network link
Steady Orange	100Mbps network link
Off	10Mbps or no link

Pin	Definition	Pin	Definition
1	LAN1TCT	2	MDI_MINUS3
3	MDI_PLUS3	4	MDI_MINUS2
5	MDI_PLUS2	6	MDI_MINUS1
7	MDI_PLUS1	8	MDI_MINUS0
9	MDI_PLUS0	10	GND
11	LAN1ACTPW	12	LAN1LEDACTN
13	LAN1LED100#	14	LAN1LINK
NH1	NC	NH2	NC
MH1	REAR_GND	MH2	REAR_GND

Pin	Definition	Pin	Definition
1	LAN2TCT	2	LAN2MDI3N
3	LAN2MDI3P	4	LAN2MDI2N
5	LAN2MDI2P	6	LAN2MDI1N
7	LAN2MDI1P	8	LAN2MDI0N
9	LAN2MDI0P	10	GND
11	LAN2ACTCON	12	LAN2LEDACTN
13	LAN2100CON	14	LAN2LINK1GN
NH1	NC	NH2	NC
MH1	REAR_GND	MH2	REAR_GND

Mic In (Pink) Connector

Connector location: CN1

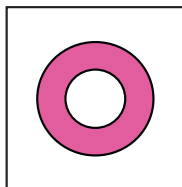

Mic-In

Pin	Definition	Pin	Definition
1	AGND	2	MIC_OUT-L
3	AGND	4	MIC_JD
5	MIC_OUT-R		

Audio Connector

Connector location: CN2

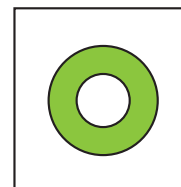

Line-Out

Pin	Definition	Pin	Definition
1	LINE_OUT_RC	2	LINEOUT_JD
3	AGND	4	LINE_OUT_LC
5	AGND		

Internal Connectors

Port 80 Connector

Connector type: 1x10 10-pin header

Connector location: J2

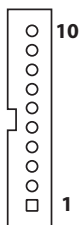

Pin	Definition	Pin	Definition
1	GND	2	SIO_PLTRSTN
3	CLKOUT_LPCI	4	ESPI_CS0#
5	ESPI_IO3	6	ESPI_IO2
7	ESPI_IO1	8	ESPI_IO0
9	SERIRQ	10	VCC3
MH1	GND	MH2	GND

Fan1 Connector

Connector type: 1x4 4-pin Wafer, 2.54mm pitch

Connector location: FAN1

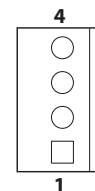

Pin	Definition	Pin	Definition
1	GND	2	VCC12
3	FANIN1	4	FANOUT1

Fan2 Connector

Connector type: 1x4 4-pin Wafer, 2.54mm pitch

Connector location: FAN2

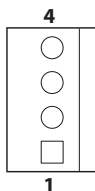

Pin	Definition	Pin	Definition
1	GND	2	VCC12
3	FANIN2	4	FANOUT2

GPIO Connector

Connector type: 2x5 10-pin header, 2.0mm pitch

Connector location: GPIO

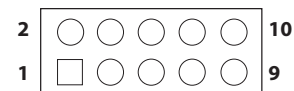

Pin	Definition	Pin	Definition
1	GPIO_PWR	2	GND
3	GPO0_OUT	4	GPIO_IN
5	GPO1_OUT	6	GP1_IN
7	GPO2_OUT	8	GPI2_IN
9	GPO3_OUT	10	GPI3_IN

SATA Connector

Connector type: Standard Serial ATAII 7P and 15P

Connector location: SATA1

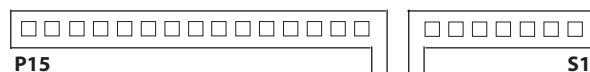

Pin	Definition	Pin	Definition
S1	GND	S2	SATA_TXP2
S3	SATA_TXN2	S4	GND
S5	SATA_RXN2	S6	SATA_RXP2
S7	GND	P1	NC
P2	NC	P3	NC
P4	GND	P5	GND
P6	GND	P7	SATA_5V
P8	SATA_5V	P9	SATA_5V
P10	GND	P11	NC
P12	GND	P13	NC
P14	NC	P15	NC

SPEK Pin Header Connector

Connector type: 1x5 5-pin header, 2.0mm pitch

Connector location: SPEK

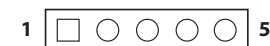

Pin	Definition	Pin	Definition
1	OUT-LR+_C	2	OUT-LR-_C
3	GND	4	OUT-RR+_C
5	OUT-RR-_C		

Reset/PUT Connector

Connector type: 1x4 4-pin header, 2.54mm pitch

Connector location: JP2



Pin	Definition	Pin	Definition
1	H_PWRBTN#_M	2	GND
3	GND	4	PM_RESET#_J

DC In for NTK-B560-PW Connector

Connector type: 2x6 12-pin header, 2.0mm pitch

Connector location: PW1

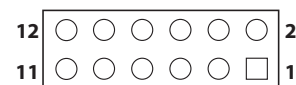

Pin	Definition	Pin	Definition
1	12VSB	2	GND
3	12VSB	4	GND
5	12VSB	6	GND
7	12VSB	8	GND
9	12VSB	10	GND
11	12VSB	12	GND

USB2.0 Pin Header Connector

Connector type: 1x6 6-pin header, 2.0mm pitch (NDiS B560-Q370 Only)

Connector location: USB4

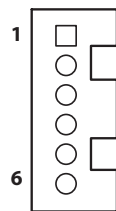

Pin	Definition	Pin	Definition
1	P5V_USB_P10	2	USB2N_10
3	USB2P_10	4	USB2N_11
5	USB2P_11	6	GND

USB2.0 Pin Header Connector

Connector type: 1x6 6-pin header, 2.0mm pitch (NDiS B560-Q370 Only)

Connector location: USB5

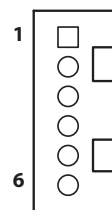

Pin	Definition	Pin	Definition
1	P5V_USB_P1213	2	USB2N_12
3	USB2P_12	4	USB2N_13
5	USB2P_13	6	GND

SMABUS Pin Header

Connector type: 1x4 4-pin header, 2.0mm pitch

Connector location: SMBUS



Pin	Definition	Pin	Definition
1	VCC3	2	SMB_CLK
3	SMB_DATA	4	GND

RI Connector

Connector type: 1x5 5-pin header

Connector location: RI



Pin	Definition	Pin	Definition
1	VCC5	2	RI_VCC12_VCC5
3	VCC12	4	RI_VCC12_VCC5
5	COM3RIL		

Battery Connector

Connector type: 1x2 2-pin header

Connector location: BAT

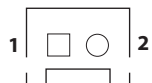

Pin	Definition
1	3V_BAT1
2	GND

CON1 Connector

Connector type: 2x2 4-pin header

Connector location: CON1

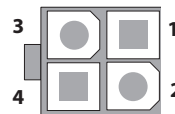

Pin	Definition	Pin	Definition
1	GND	2	GND
3	12VSB	4	12VSB

SIM Card Connector

Connector location: SIM1

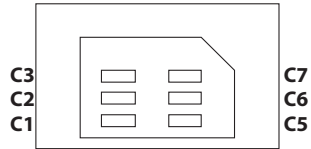

Pin	Definition	Pin	Definition
C1	UIM_PWR	C2	UIM_RESET
C3	UIM_CLK	C5	GND
C6	UIM_VPP	C7	UIM_DATA
MH1	GND	MH2	GND
CD	GND	COM	GND

NGFF Key E Connector

Connector location: M2E

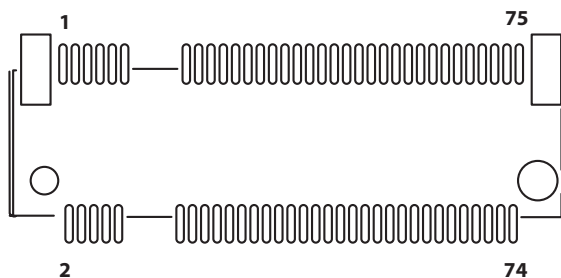

Pin	Definition	Pin	Definition
1	GND	2	NGFF_3V3
3	M2_E_USBP	4	NGFF_3V3
5	M2_E_USBN	6	NC
7	H_PCIEEXP20	8	NC
9	NC	10	NC
11	NC	12	NC
13	NC	14	NC
15	NC	16	NC
17	NC	18	GND3VSB
19	NC	20	NC
21	NC	22	NC
23	NC	24	NC
25	NC	26	NC
27	NC	28	NC
29	NC	30	NC
31	NC	32	NC

Pin	Definition	Pin	Definition
33	GND	34	NC
35	M2E_PCIE_TXP0	36	NC
37	M2E_PCIE_TXN0	38	M.2_CLINK_RST_WLAN_N
39	GND	40	M.2_CLINK_DATA_WLAN
41	H_PCIEEXP8	42	M.2_CLINK_CLK_WLAN
43	H_PCIEEXP8	44	NC
45	GND	46	NC
47	I_CLKOUTPCIEP7	48	NC
49	I_CLKOUTPCIEP7	50	PCIEREQ#_NGFF_R
51	GND	52	CONFIG_0
53	SRCCLKREQ7N	54	CONFIG_1
55	I_WAKEN	56	CONFIG_2
57	GND	58	NC
59	M2E_PCIE_TXP1	60	NC
61	M2E_PCIE_TXN1	62	NC
63	GND	64	NC
65	H_PCIEEXP7	66	RST_M2E
67	H_PCIEEXP7	68	SRCCLKREQ6N
69	GND	70	I_WAKEN
71	I_CLKOUTPCIEP6	72	NGFF_3V3
73	I_CLKOUTPCIEP6	74	NGFF_3V3
75	GND		

NGFF Key M Connector

Connector location: M2M

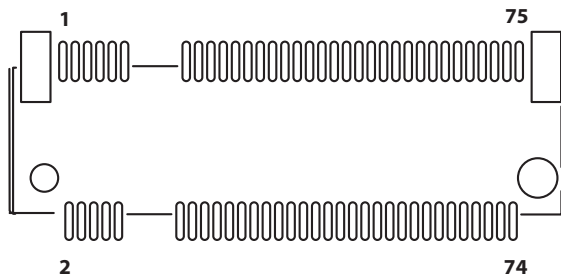

Pin	Definition	Pin	Definition
1	GND	2	3VSB
3	GND	4	3VSB
5	H_PCIERXN20	6	NC
7	H_PCIERP20	8	NC
9	GND	10	DSS#_1
11	PCIETXN20	12	3VSB
13	PCIETXP20	14	3VSB
15	GND	16	3VSB
17	H_PCIERXN19	18	3VSB
19	H_PCIERP19	20	NC
21	GND	22	NC
23	PCIETXN19	24	NC
25	PCIETXP19	26	NC
27	GND	28	NC
29	H_PCIERXN18	30	NC
31	H_PCIERP18	32	NC

Pin	Definition	Pin	Definition
33	GND	34	NC
35	PCIETXN18	36	NC
37	PCIETXP18	38	DEVSLP_0
39	GND	40	NC
41	PCIERP17	42	NC
43	PCIERXN17	44	NC
45	GND	46	NC
47	PCIETXN17	48	NC
49	PCIETXP17	50	M2_PLTRSTN1
51	GND	52	SRCLKREQ3N
53	I_CLKOUTPCIE3	54	I_WAKEN
55	I_CLKOUTPCIE3	56	NC
57	GND	58	NC
59	NC	60	NC
61	NC	62	NC
63	NC	64	NC
65	NC	66	NC
67	NC	68	I_SUSCLK2
69	S_SATAXP4	70	3VSB
71	NC	72	3VSB
73	GND	74	3VSB
75	GND		

NGFF Key B Connector

Connector location: M2B

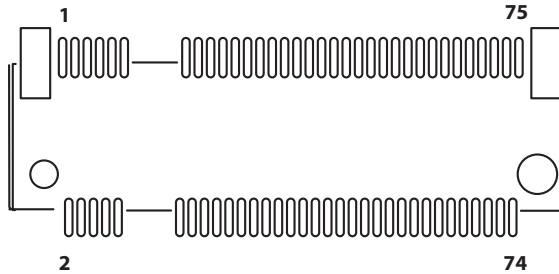

Pin	Definition	Pin	Definition
1	CONFIG_3	2	3VSB
3	GND	4	3VSB
5	GND	6	POWEROFF
7	S_USB2P_2	8	M2LTEDISL
9	S_USB2N_2	10	NC
11	GND	12	
13		14	
15		16	
17		18	
19		20	NC
21	CONFIG_0	22	NC
23	I_WAKEN	24	NC
25	NC	26	NC
27	GND	28	NC
29	H_USB31_RXN7	30	UIM_RESET
31	H_USB31_RXP7	32	UIM_CLK

Pin	Definition	Pin	Definition
33	GND	34	UIM_DATA
35	H_USB31_TXN7	36	UIM_PWR
37	H_USB31_TXP7	38	NC
39	GND	40	NC
41	NC	42	NC
43	NC	44	NC
45	GND	46	NC
47	NC	48	NC
49	NC	50	M2_B_PERST
51	GND	52	NC
53	NC	54	M2_B_PEWAKE
55	NC	56	NC
57	GND	58	NC
59	NC	60	NC
61	NC	62	NC
63	NC	64	NC
65	NC	66	NC
67	M2LTERSTL	68	NC
69	M2LTECONFIG1	70	3VSB
71	GND	72	3VSB
73	GND	74	3VSB
75	M2LTECONFIG2		

Block Diagram

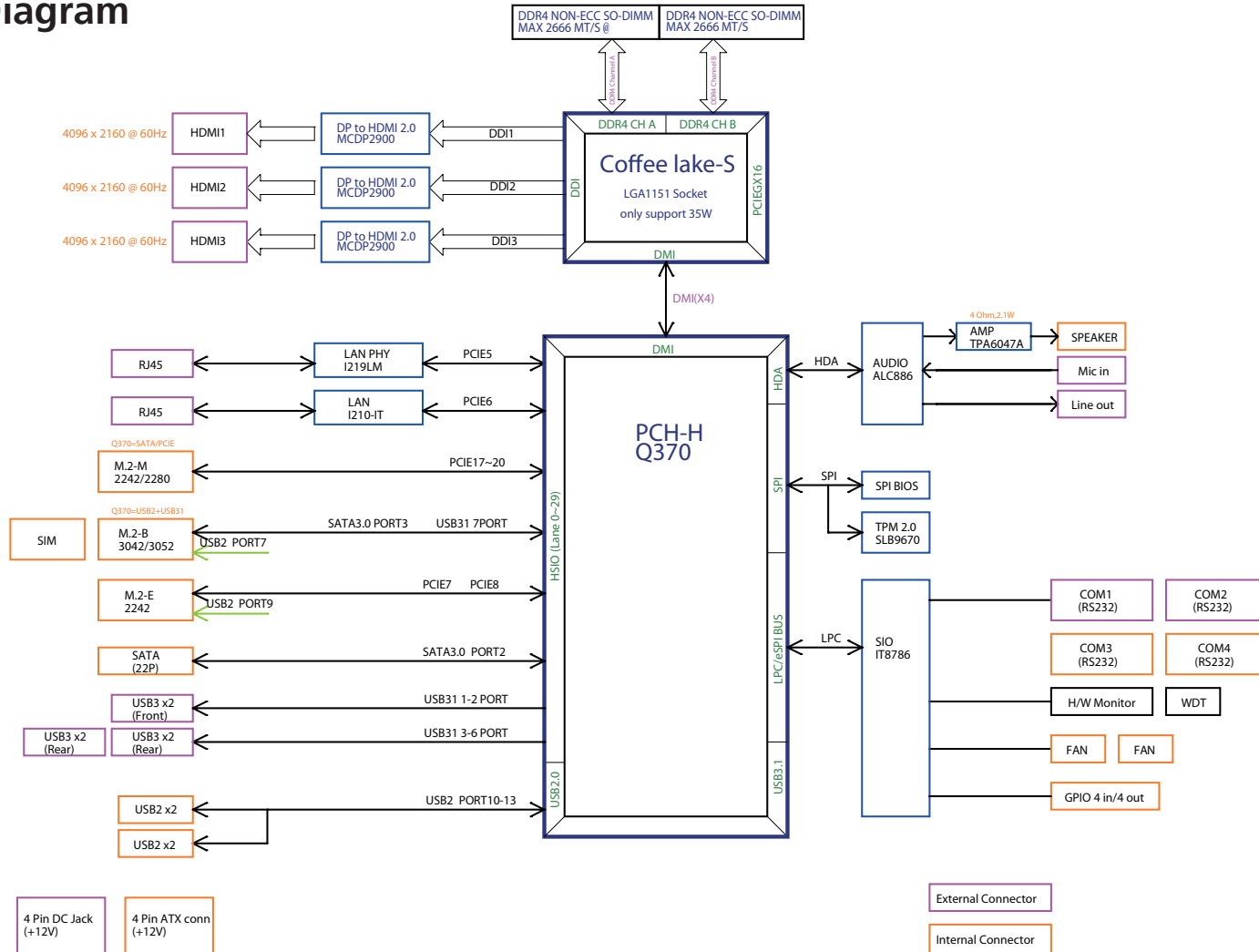

Chapter 3: System Setup

Removing the Chassis Cover



Prior to removing the chassis cover, make sure the unit's power is off and disconnected from the power sources to prevent electric shock or system damage.

1. The screws on the front, rear and bottom are used to secure the cover to the chassis. Remove these screws and put them in a safe place for later use.

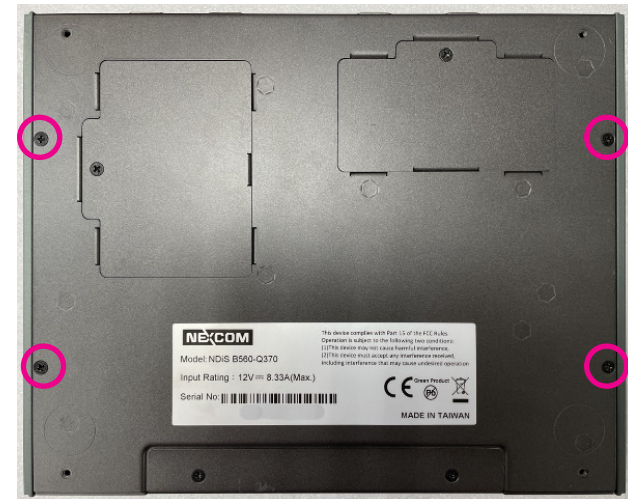

2. Remove the top cover.



Installing a CPU

1. Remove the four screws and CPU heatsink.

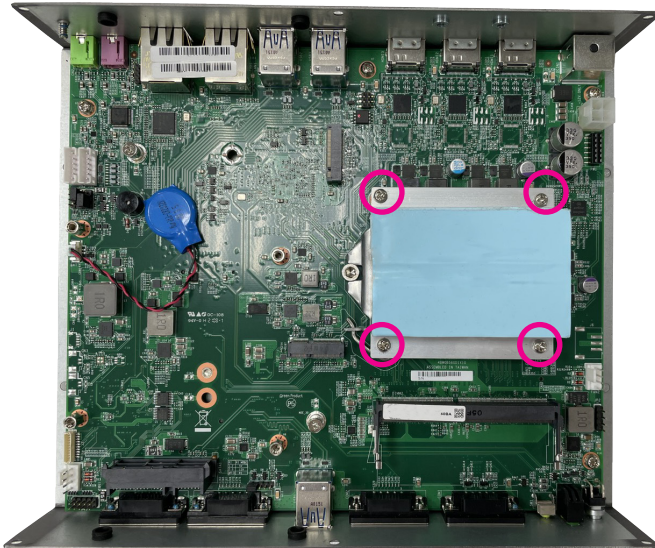

2. Locate the CPU socket on the board. Unlock the socket by pushing the load lever down, moving it sideways until it is released from the retention tab.

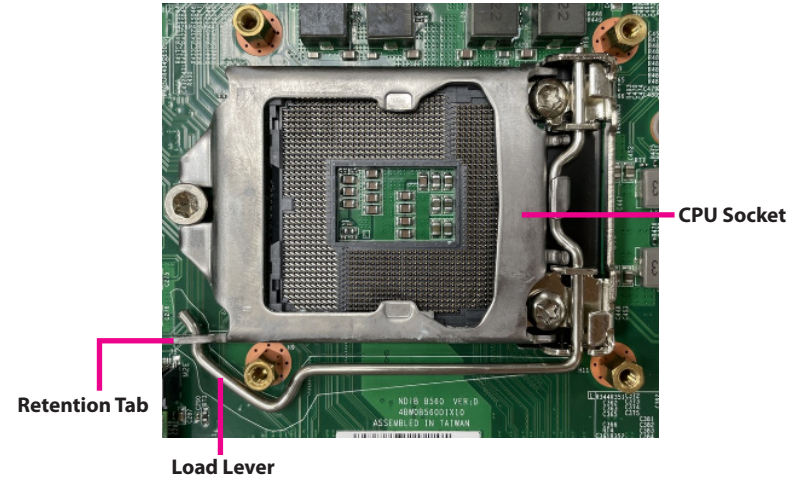

3. Lift the load lever up to open the CPU retention bracket.

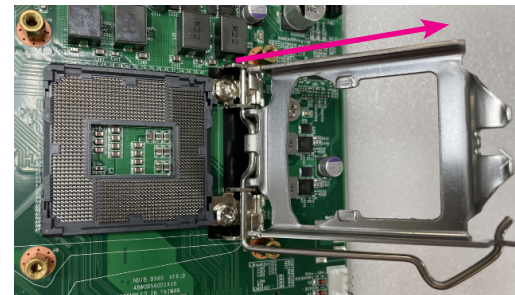

4. Insert the CPU into the socket. The triangular edge on the CPU must align with the corner of the CPU socket shown in the photo. The CPU's notch will at the same time fit into the socket's alignment key.

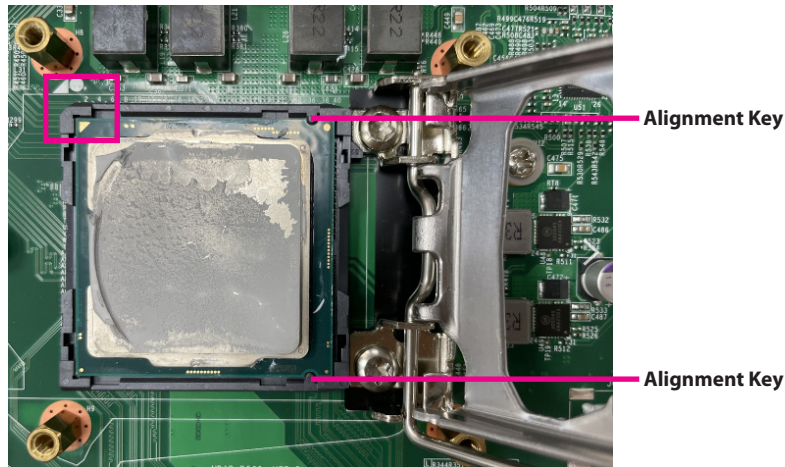

5. With the CPU installed, close the retention bracket and then hook the load lever under the retention tab. Ensure that the notch on the retention bracket is slid under the screw before lowering the load lever as shown below.

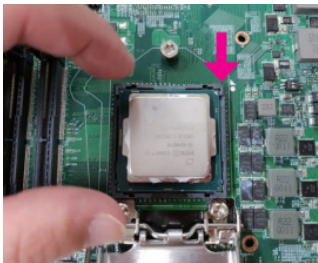
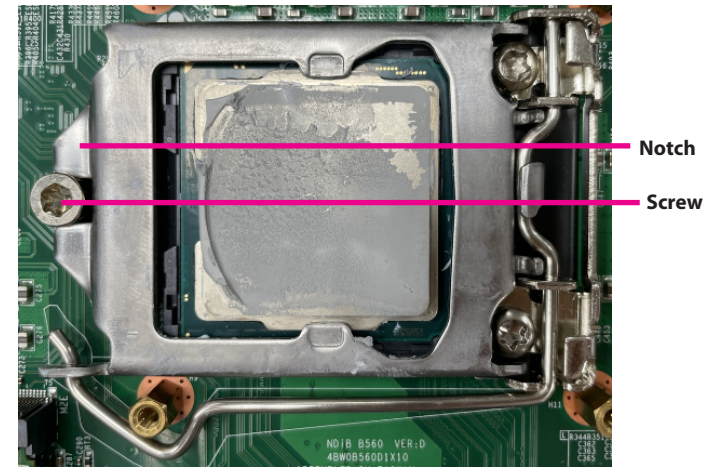
**CAUTION:**

- Handle the CPU by its edges and avoid touching the pins.
- The CPU will fit only in one orientation and can easily be inserted without exerting any force.

**CAUTION:**

Do not force the CPU into the socket. Forcing the CPU into the socket may bend the pins and damage the CPU.

6. Align the CPU heatsink.



7. Secure the CPU heatsink with the four screws.

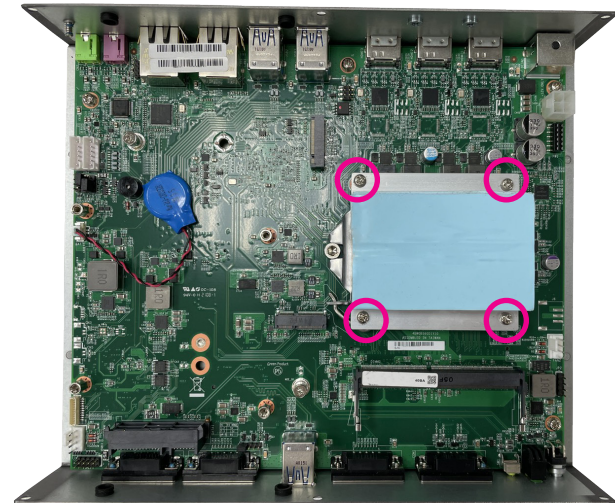

Installing a SO-DIMM (DIMM2)

1. Locate the SO-DIMM socket on the board.

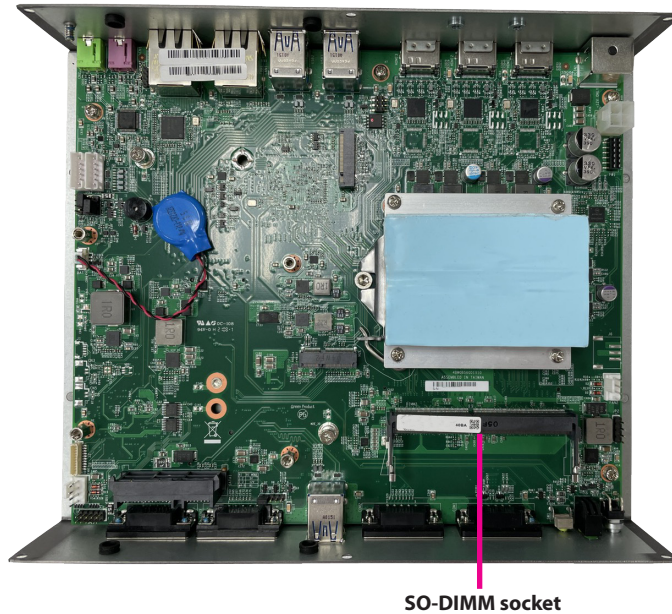

2. Insert the module into the socket at an approximately 30 degree angle. The ejector tabs at the ends of the socket will automatically snap into the locked position to hold the module in place.

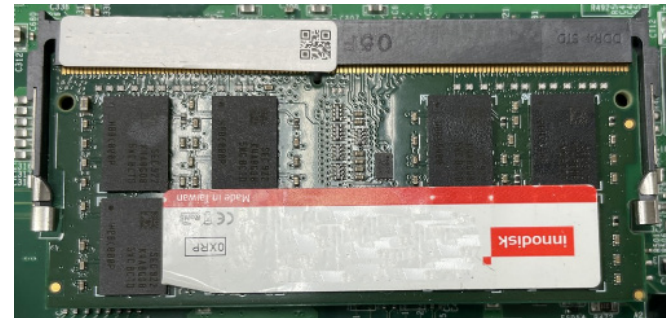

Installing a SO-DIMM (DIMM1)

1. Remove the screw from the SO-DIMM cover at the bottom side.



2. Insert the module into the socket at an approximately 30 degrees angle. The ejector tabs at the ends of the socket will automatically snap into the locked position, holding the module in place.

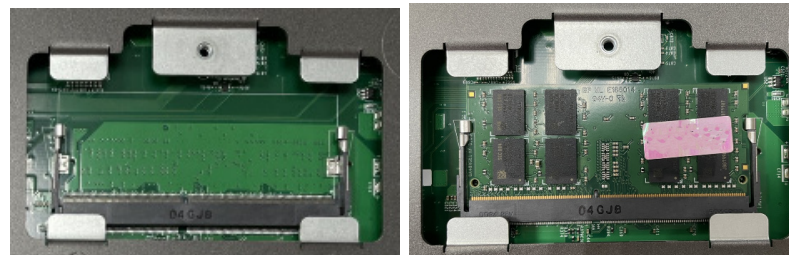

3. Secure the SO-DIMM cover with the screw.



Installing a HDD



Please correctly follow the below instructions and noted items to avoid making unnecessary damages.

1. Secure the HDD bracket to the HDD with the four screws.



2. Locate the SATA connector on the board.

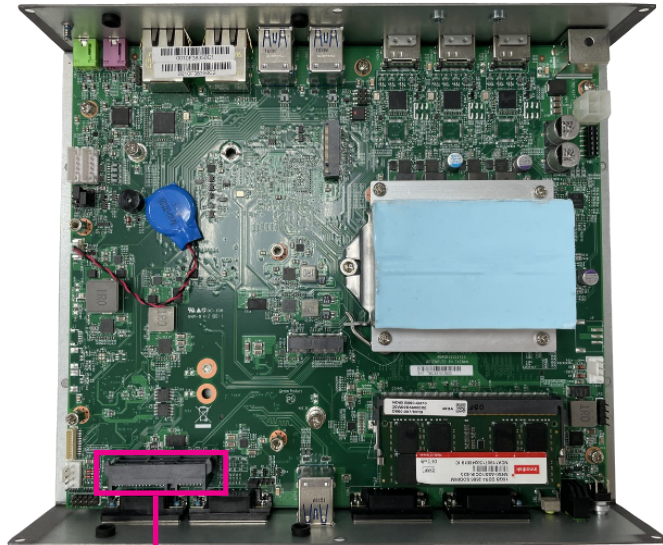

SATA connector

3. Insert the HDD and the SATA connector and then secure the HDD with the HDD bracket to the board with the four screws.



Installing a M.2 Storage Module (M-key 2280)

1. Locate the M.2 M-key slot on the board.

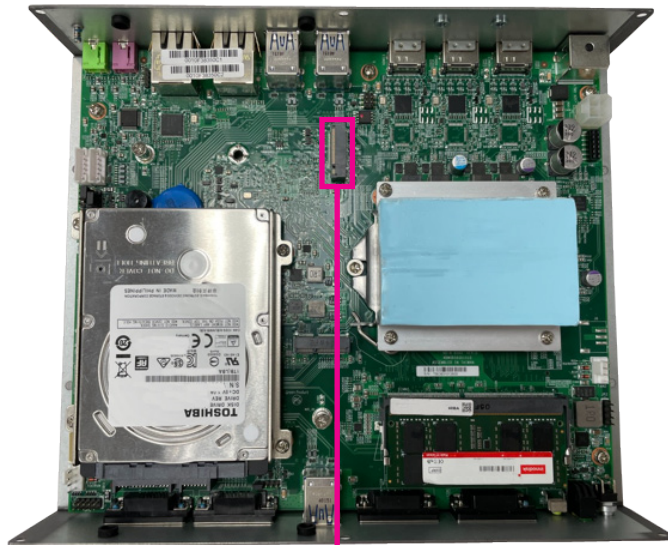

M.2 M-key slot

2. Remove the screws, and keep it for later use. (For step 4)

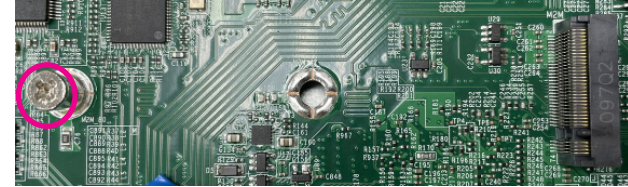

3. Insert the M.2 module into the M.2 slot at a 45-degree angle until the gold-plated connector on the edge of the module completely disappears into the slot.



4. Push the module down and secure it with the mounting screw.
(From step 2)

5. When purchasing a M.2 storage, it is recommended to use a complementary dedicated thermal pad. Stick it to the original set of M.2 module for a better heat dissipation.



Installing a M.2 WiFi Module (E-key 2230)

1. Locate the M.2 M-key slot on the board.

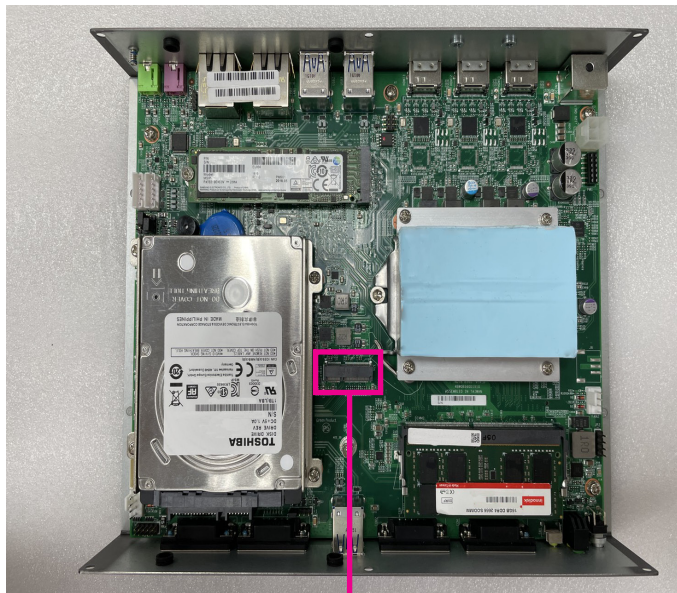

M.2 E-key slot

2. Remove the screws, and keep it for later use. (For step 4)

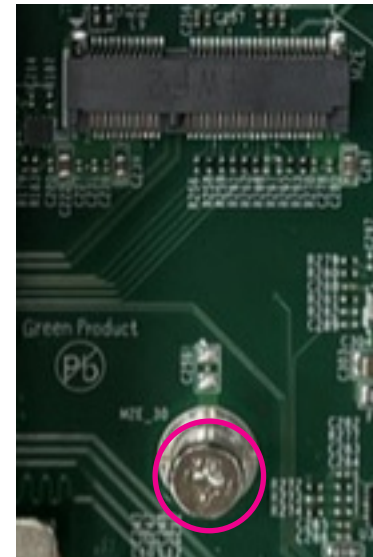

3. Insert the WiFi module into the M.2 E-key slot at a 45-degree angle until the gold-plated connector on the edge of the module completely disappears into the slot.



4. Push the WiFi module down and secure it with the screw. (From step 2)



Assembling The Top Cover To The Chassis

1. Align the top cover and PCB.

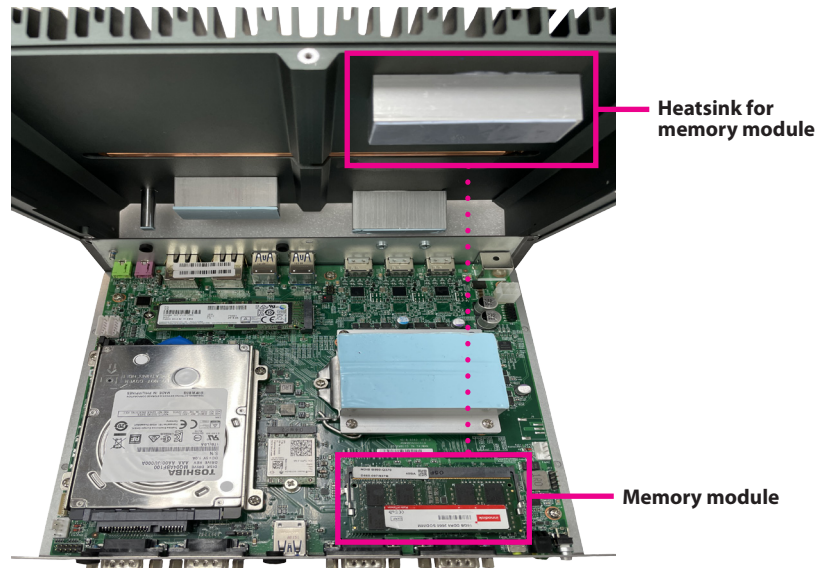

2. Slide the top cover to the chassis and secure it with the 10 screws.

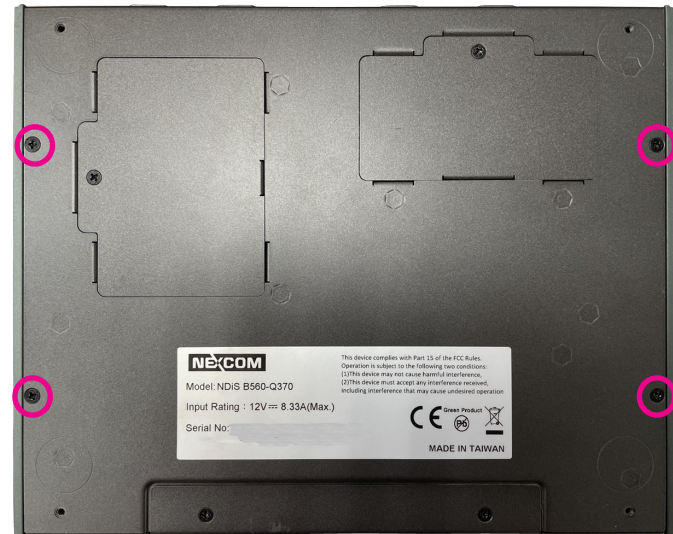

Installing a M.2 LTE/5G module (B-key 3042/3052) and SIM card

1. Remove the screw from the LTE cover at the bottom side.



2. Remove the screws, and keep it for later use. (For Step 4)

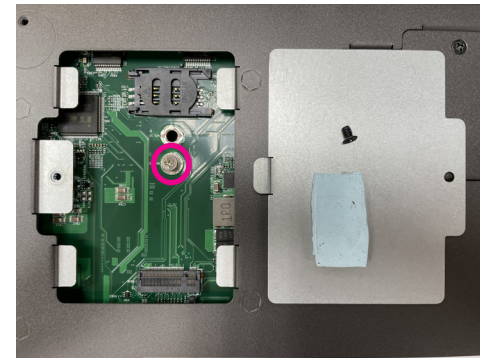

3. Insert the LTE/5G module into the M.2 B-key slot at an approximately 30 degrees angle. The ejector tabs at the ends of the socket will automatically snap into the locked position holding the module in place.

4. Push the LTE/5G module down then secure it with the screw.
(From step 2)

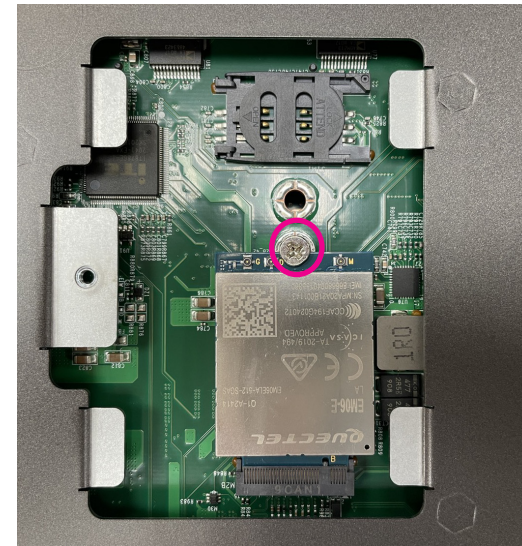
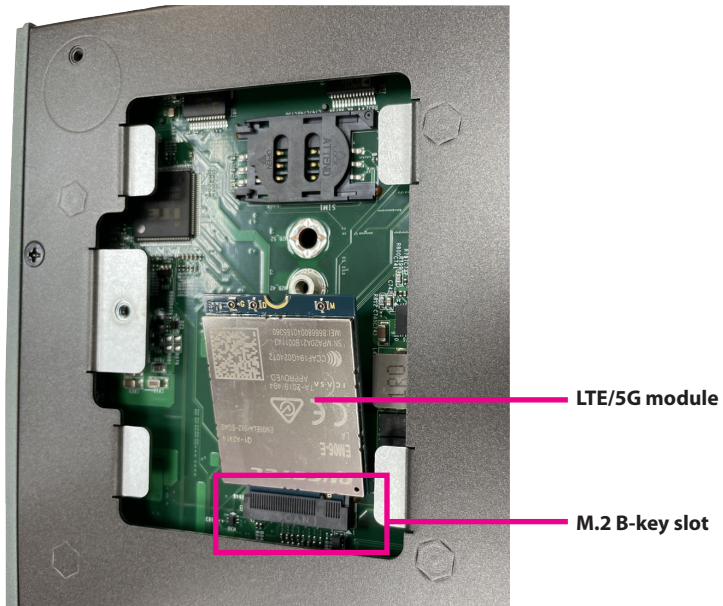

5. Open the SIM card holder and place the SIM card onto the holder.

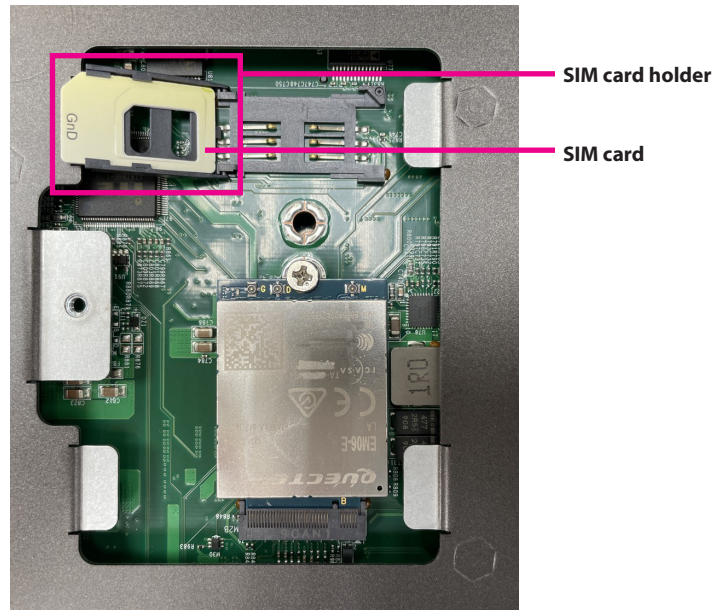

6. Close the holder and secure it to the original position.

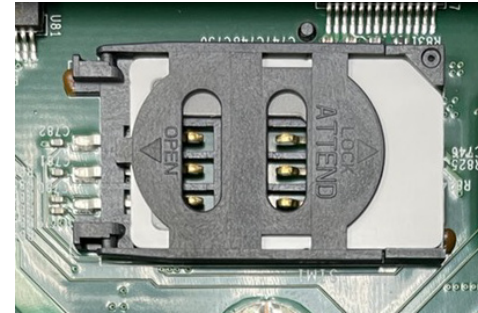

7. Secure the LTE cover with the screw.

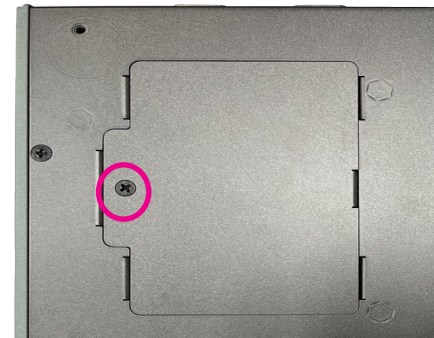

Chapter 4: BIOS Setup

This chapter describes how to use the BIOS setup program for the NDiS B560. The BIOS screens provided in this chapter are for reference only and may change if the BIOS is updated in the future.

To check for the latest updates and revisions, visit the NEXCOM Web site at www.nexcom.com.tw.

About BIOS Setup

The BIOS (Basic Input and Output System) Setup program is a menu driven utility that enables you to make changes to the system configuration and tailor your system to suit your individual work needs. It is a ROM-based configuration utility that displays the system's configuration status and provides you with a tool to set system parameters.

These parameters are stored in non-volatile battery-backed-up CMOS RAM that saves this information even when the power is turned off. When the system is turned back on, the system is configured with the values found in CMOS.

With easy-to-use pull down menus, you can configure such items as:

- Hard drives, diskette drives, and peripherals
- Video display type and display options
- Password protection from unauthorized use
- Power management features

The settings made in the setup program affect how the computer performs. It is important, therefore, first to try to understand all the setup options, and second, to make settings appropriate for the way you use the computer.

When to Configure the BIOS

- This program should be executed under the following conditions:
 - When changing the system configuration
 - When a configuration error is detected by the system and you are prompted to make changes to the setup program
 - When resetting the system clock
 - When redefining the communication ports to prevent any conflicts
 - When making changes to the Power Management configuration
 - When changing the password or making other changes to the security setup

Normally, CMOS setup is needed when the system hardware is not consistent with the information contained in the CMOS RAM, whenever the CMOS RAM has lost power, or the system features need to be changed.

Default Configuration

Most of the configuration settings are either predefined according to the Load Optimal Defaults settings which are stored in the BIOS or are automatically detected and configured without requiring any actions. There are a few settings that you may need to change depending on your system configuration.

Entering Setup











When the system is powered on, the BIOS will enter the Power-On Self Test (POST) routines. These routines perform various diagnostic checks; if an error is encountered, the error will be reported in one of two different ways:

- If the error occurs before the display device is initialized, a series of beeps will be transmitted.
- If the error occurs after the display device is initialized, the screen will display the error message.

Powering on the computer and immediately pressing allows you to enter Setup.

Press the  key to enter Setup:

Legends

Key	Function
	Moves the highlight left or right to select a menu.
	Moves the highlight up or down between sub-menus or fields.
	Exits the BIOS Setup Utility.
	Scrolls forward through the values or options of the highlighted field.
	Scrolls backward through the values or options of the highlighted field.
	Selects a field.
	Displays General Help.
	Load previous values.
	Load optimized default values.
	Saves and exits the Setup program.
	Press <Enter> to enter the highlighted sub-menu

Scroll Bar

When a scroll bar appears to the right of the setup screen, it indicates that there are more available fields not shown on the screen. Use the up and down arrow keys to scroll through all the available fields.

Submenu

When “▶” appears on the left of a particular field, it indicates that a submenu which contains additional options are available for that field. To display the submenu, move the highlight to that field and press  .

BIOS Setup Utility

Once you enter the AMI BIOS Setup Utility, the Main Menu will appear on the screen. The main menu allows you to select from several setup functions and one exit. Use arrow keys to select among the items and press  to accept or enter the submenu.

Main

The Main menu is the first screen that you will see when you enter the BIOS Setup Utility.

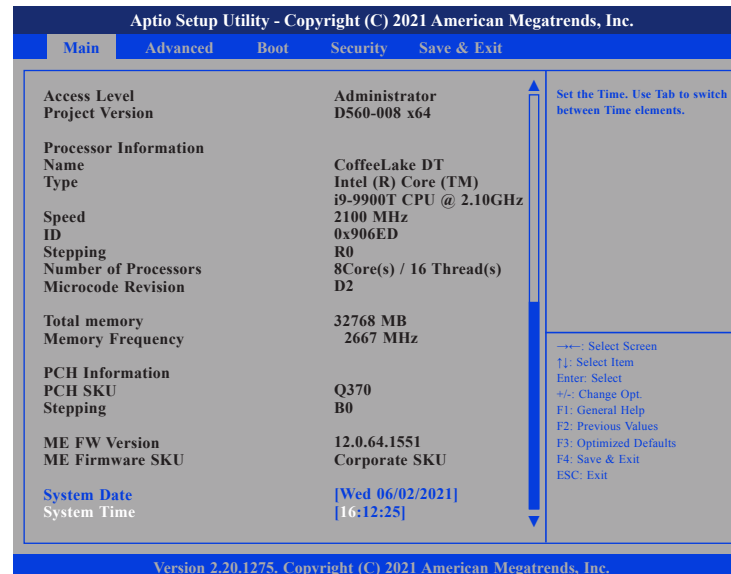
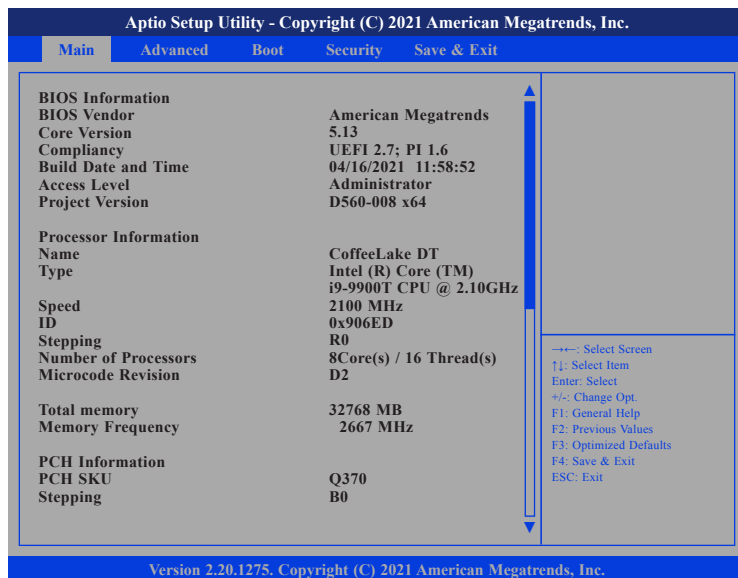

System Date

The date format is <day>, <month>, <date>, <year>. Day displays a day, from Monday to Sunday. Month displays the month, from January to December. Date displays the date, from 1 to 31. Year displays the year, from 1999 to 2099.

System Time

The time format is <hour>, <minute>, <second>. The time is based on the 24-hour military-time clock. For example, 1 p.m. is 13:00:00. Hour displays hours from 00 to 23. Minute displays minutes from 00 to 59. Second displays seconds from 00 to 59.

Advanced

The Advanced menu allows you to configure your system for basic operation. Some entries are defaults required by the system board, while others, if enabled, will improve the performance of your system or let you set some features according to your preference.



Setting incorrect field values may cause the system to malfunction.



CPU Configuration

This section is used to configure the CPU.

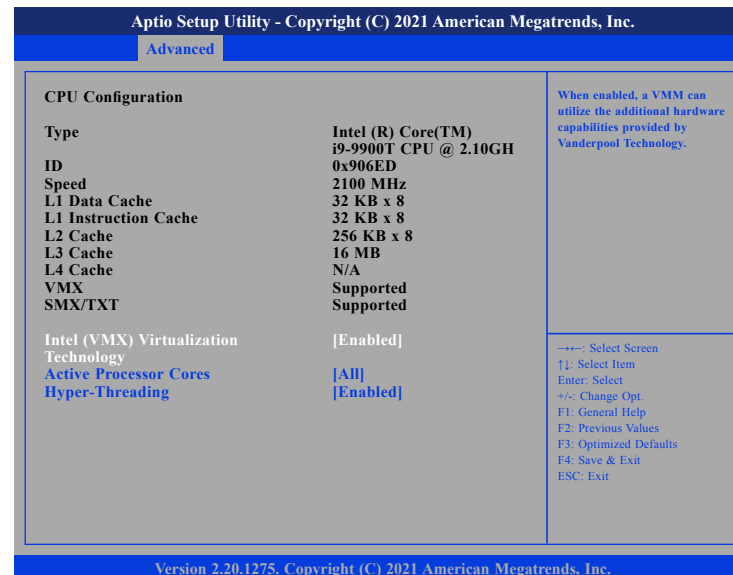

Intel® Virtualization Technology

When this field is set to Enabled, the VMM can utilize the additional hardware capabilities provided by Vanderpool Technology.

Active-Processor Cores

Select the number of cores to enable in each processor package.

Hyper-Threading

This field is used to enable or disable hyper-threading.

Power & Performance

This section is used to configure the CPU power management features.



CPU - Power Management Control

Configures the CPU power management control options.

CPU Power Management

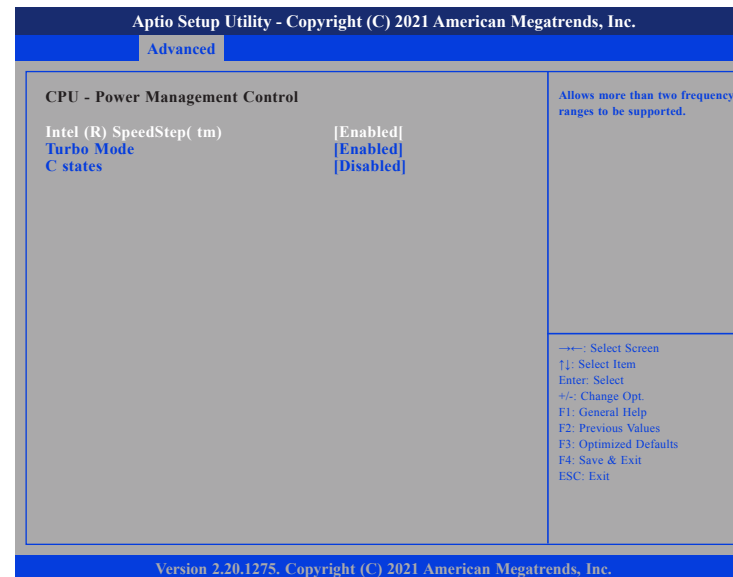

Intel® SpeedStep

Enables or disables Intel SpeedStep.

Turbo Mode

Enables or disables turbo mode.

C states

Enables or disables CPU C states support for power saving.

PCH-FW Configuration

This section is used to configure the firmware update options.

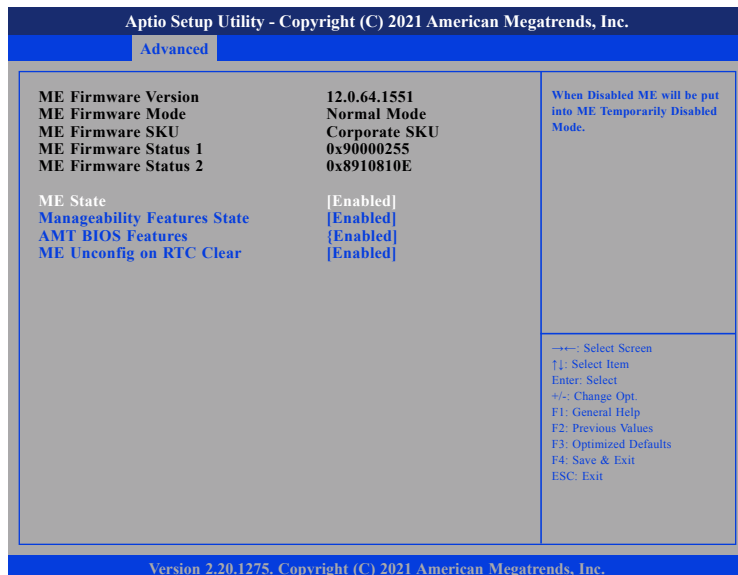

ME State

Enable or disables ME state. When disabled, ME will be placed into ME Temporarily Disabled Mode.

Manageability Features State

Enable or disable Intel (R) Manageability features. This option disables/enables Manageability Features support in FW. To disable, support platform must be in an unprovisioned state first.

AMT Bios Features

Enables or disables AMT BIOS features. When disabled, user will no longer be able to access MEBx setup.

ME Unconfig on RTC Clear

When disabled, ME will not be unconfigured on RTC Clear.

AMT Configuration

This section is used to configure AMT settings.



ASF support

Enables or disables Alert Standard Format support.

USB Provisioning of AMT

Enables or disables USB Provisioning of AMT.

CIRA Configuration

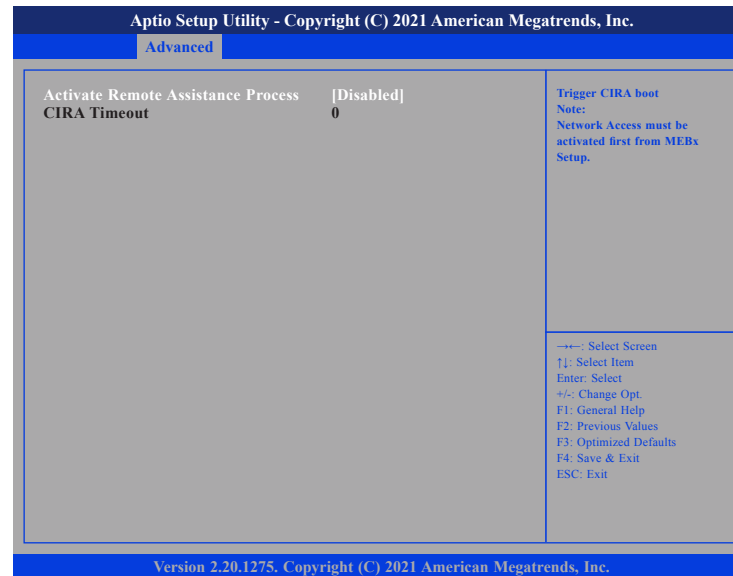

Activate Remote Assistance Process

Enables or disables Activate Remote Assistance Process.

ASF Configuration



PET Progress

Enables or disables PET Events Progress to receive PET Events.

WatchDog

Enables or disables watchdog timer.

ASF Sensors Table

Enables or disables the option to add ASF Sensor Table into ASF ACPI Table.

Secure Erase Configuration



Secure Erase mode

Configures the Secure Erase module behavior.

Simulated: Performs SE flow without erasing SSD.

Real: Erases SSD.

Force Secure Erase

Enables or disables the option to Force Secure Erase on next boot.

OEM Flags Settings

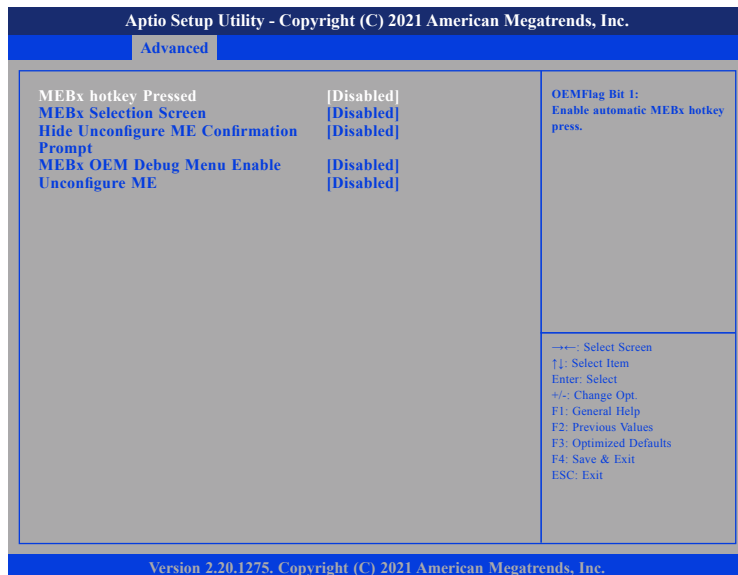

MEBx hotkey Pressed

Enables or disables automatic MEBx hotkey press.

MEBx Selection Screen

Enables or disables MEBx selection screen with 2 options.

- Press 1 to enter ME configuration screens.
- Press 2 to initiate a remote connection.

Hide Unconfigure ME Confirmation Prompt

Enables or disables the option to hide unconfigure ME confirmation prompt when attempting ME unconfiguration.

MEBx OEM Debug Menu Enable

Enables or disables OEM debug menu in MEBx.

Unconfigure ME

Enables Unconfigure ME without password or disables Unconfigure ME.

MEBx Resolution Settings

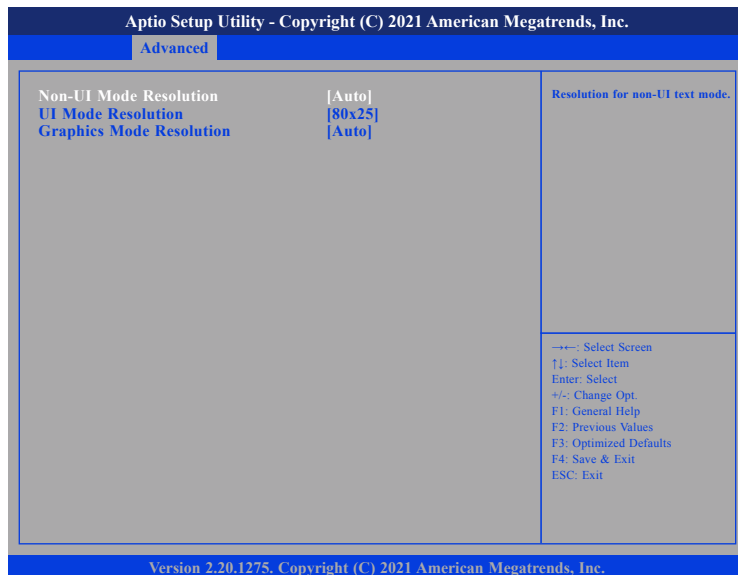

Non-UI Mode Resolution

Configures the resolution for non-UI text mode.

UI Mode Resolution

Configures the resolution for UI text mode.

Graphics Mode Resolution

Configures the resolution for graphics mode.

Trusted Computing

This section is used to configure Trusted Platform Module (TPM) settings

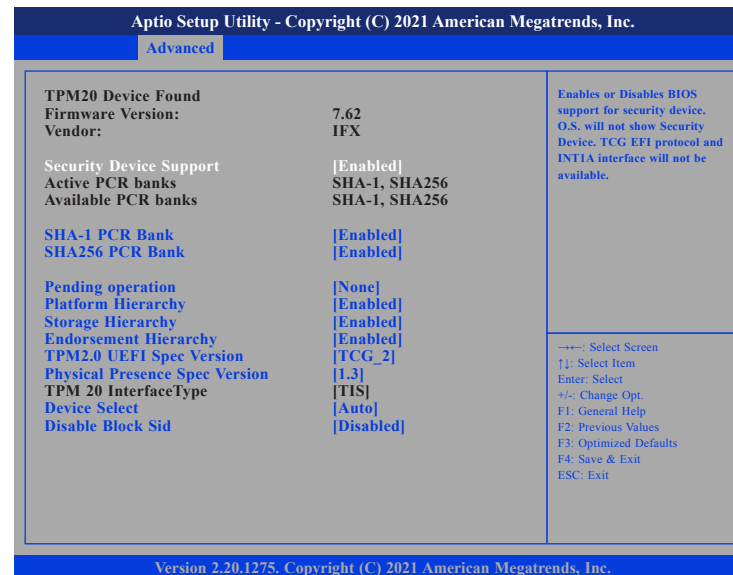

Security Device Support

Enables or disables BIOS support for security device. O.S will not show Security Device. TCG EFI protocol and INT1A interface will not be available.

SHA-1 PCR Bank

Enables or disables SHA-1 PCR Bank.

SHA256 PCR Bank

Enables or disables SHA256 PCR Bank.

Pending operation

Schedules an operation for the security device.

Platform Hierarchy

Enables or disables Platform Hierarchy.

Storage Hierarchy

Enables or disables Storage Hierarchy.

Endorsement Hierarchy

Enables or disables Endorsement Hierarchy.

TPM2.0 UEFI Spec Version

Configures the TPM2.0 UEFI spec version.

TCG_1_2: The compatible mode Windows 8/Windows 10.

TCG_2: Support new TCG2 protocol and event format for Windows 10 or later.

Physical Presence Spec Version

Configures which physical presence spec version the OS will support. Please note that some HCK tests might not support 1.3.

Device Select

TPM 1.2 will restrict support to TPM 1.2 devices. TPM 2.0 will restrict support to TPM 2.0 devices. Auto will support both TPM 1.2 and 2.0 devices with the default set to TPM 2.0 devices if not found, and TPM 1.2 devices will be enumerated.

Disable Block Sid

Enables or disables the option to allow SID authentication in TCG storage device.

IT8786 Super IO Configuration

This section is used to configure the serial ports.

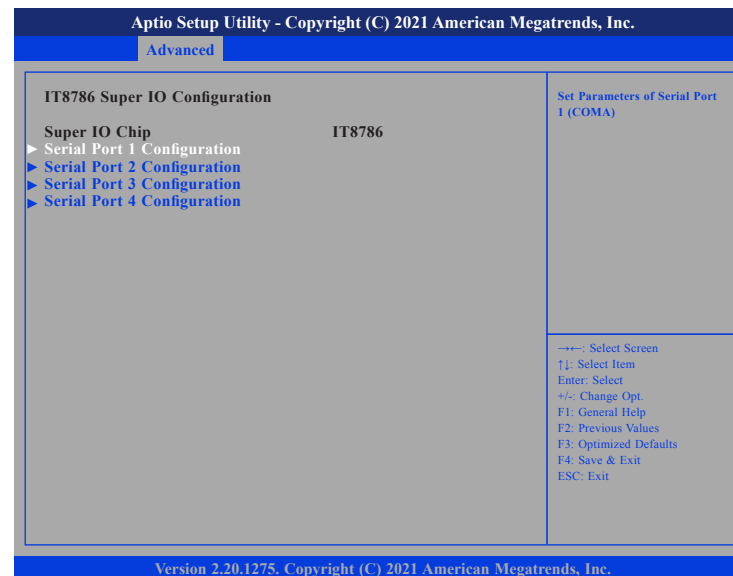

Super IO Chip

Displays the Super I/O chip used on the board.

Serial Port 1 Configuration

This section is used to configure serial port 1.

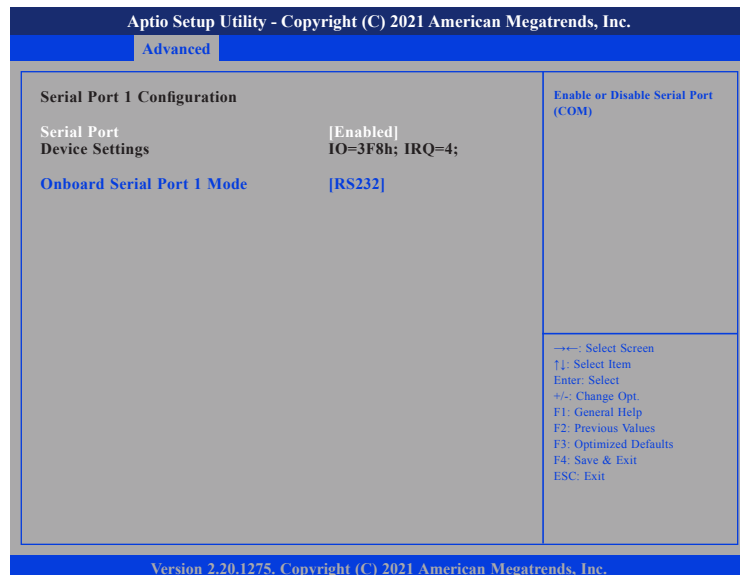

Serial Port

Enables or disables the serial port.

Onboard Serial Port Mode

Select this to change the serial port mode to RS232, RS422, RS485 No Terminator or RS485 With Terminator.

Serial Port 2 Configuration

This section is used to configure serial port 2.

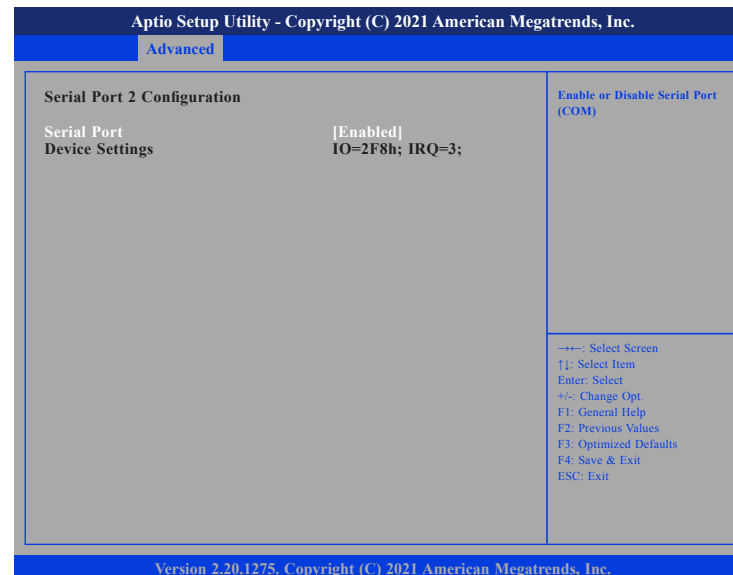

Serial Port

Enables or disables the serial port.

Serial Port 3 Configuration

This section is used to configure serial port 3.

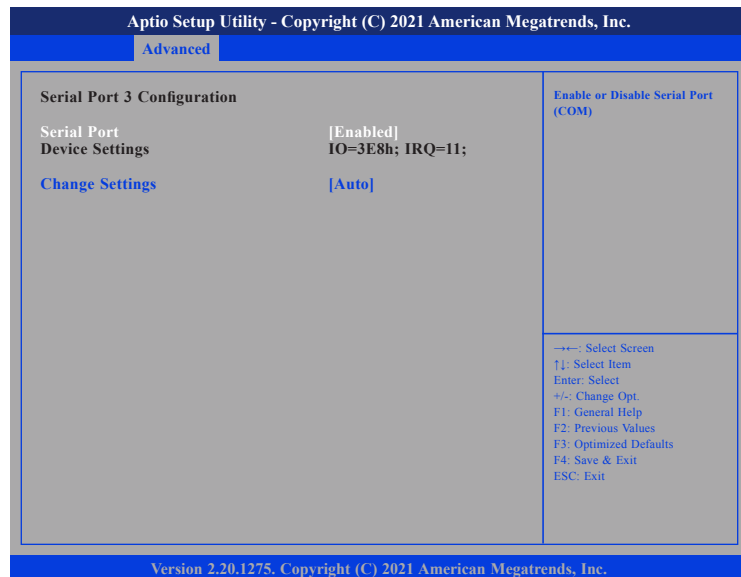

Serial Port

Enables or disables the serial port.

Serial Port 4 Configuration

This section is used to configure serial port 4.

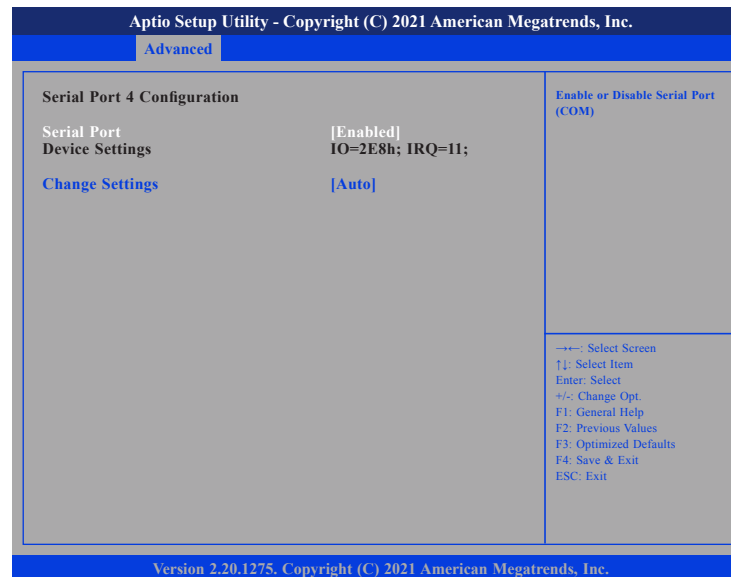

Serial Port

Enables or disables the serial port.

IT8786 HW Monitor

This section is used to monitor hardware status such as temperature, fan speed and voltages.

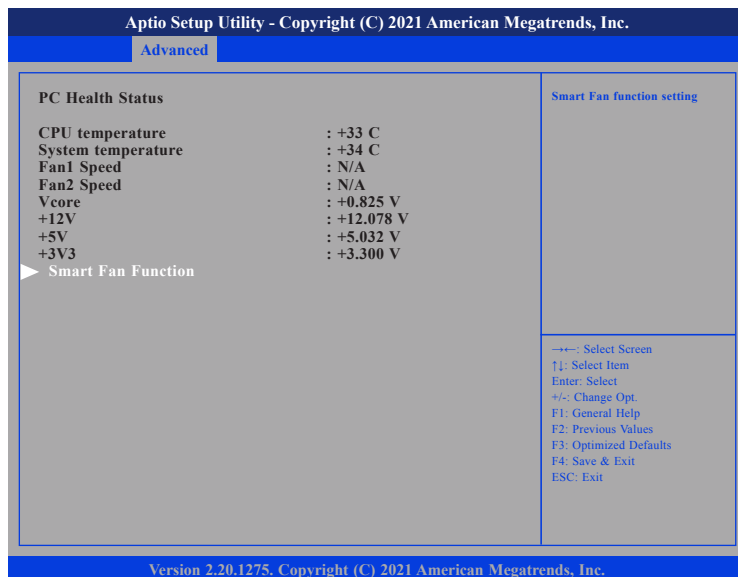

CPU temperature

Detects and displays the current CPU temperature.

System temperature

Detects and displays the current system temperature.

Fan1 and Fan2 Speed

Detects and displays the current fan speed of the fans connected to Fan 1 and Fan 2.

VCORE to +3.3V

Detects and displays the output voltages

USB Configuration

This section is used to configure the USB.

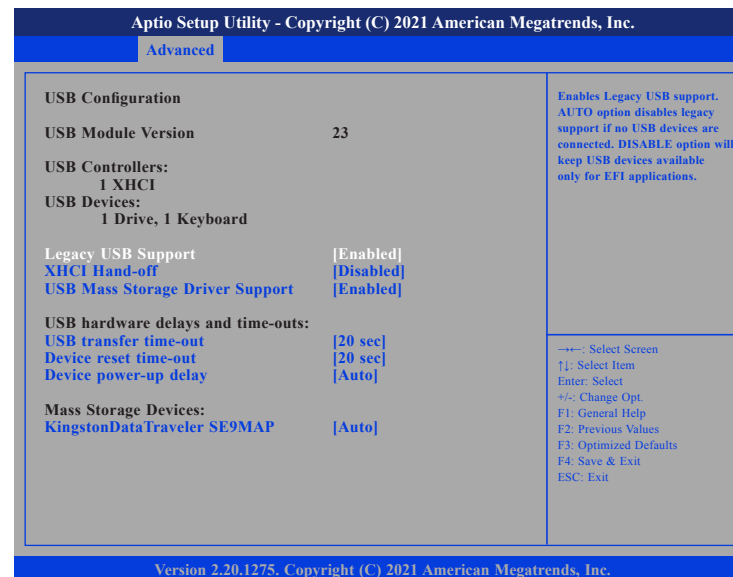

XHCI Hand-off

This is a workaround for OSs that does not support XHCI hand-off. The XHCI ownership change should be claimed by the XHCI driver.

USB Mass Storage Driver Support

Enables or disables USB mass storage device driver support.

USB transfer time-out

The time-out value for control, bulk, and Interrupt transfers.

Device reset time-out

Selects the USB mass storage device's start unit command timeout.

Device power-up delay

Maximum time the value will take before it properly reports itself to the Host Controller. "Auto" uses default value: for a Root port it is 100 ms, for a Hub port the delay is taken from Hub descriptor.

NVMe Configuration

This section is used to display information on the NVMe devices installed.

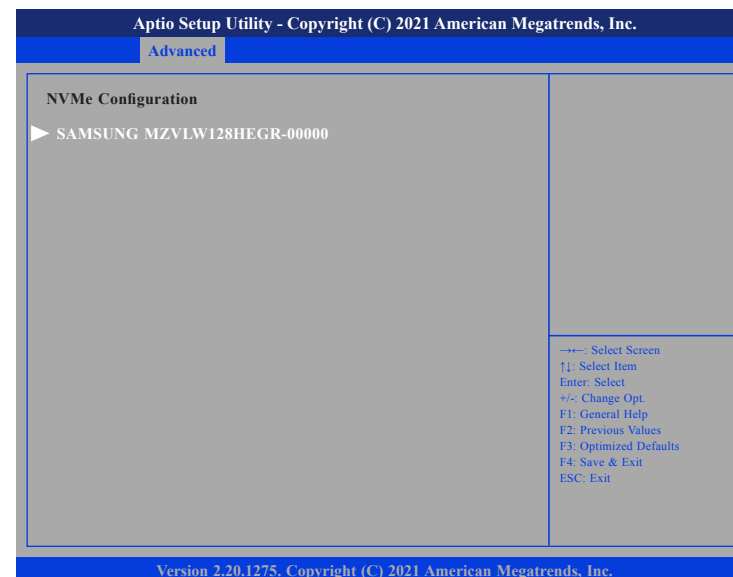

NVMe Device (128GB PCIe Drive)



Aptio Setup Utility - Copyright (C) 2021 American Megatrends, Inc.

Advanced

Seg:Bus:Dev:Func Model Number	00:02:00:00 SAMSUNG M2VLW128HEGR-00000	Select either Short or Extended Self Test. Short option will take couple of minutes and extended option will take several minutes to complete.
Total Size Vendor ID Device ID	128.0 GB 144D A804	
Namespace: 1	Size: 128.0 GB	
Device Self Test: Self Test Option Self Test Action Run Device Self Test	[Short] [Controller Only Test]	
Short Device Selftest Result Extended Device Selftest Result	[Not Available] [Not Available]	---: Select Screen ↑↓: Select Item Enter: Select +/-: Change Opt. F1: General Help F2: Previous Values F3: Optimized Defaults F4: Save & Exit ESC: Exit

Version 2.20.1275. Copyright (C) 2021 American Megatrends, Inc.

Run Device Self Test

Run the device self test according to the self test option and action selected. Pressing the Esc key will abort the test.

Self Test Option

Configures the method used for self test.

Short Short option will take couple of minutes to complete.
 Extended Extended option will take several minutes to complete.

Self Test Action

Configures the items used for self test. Controller Only Test and Controller and NameSpace Test options are available. Selecting Controller and NameSpace Test will take longer to complete.

Network Stack Configuration

This section is used to configure the network stack.

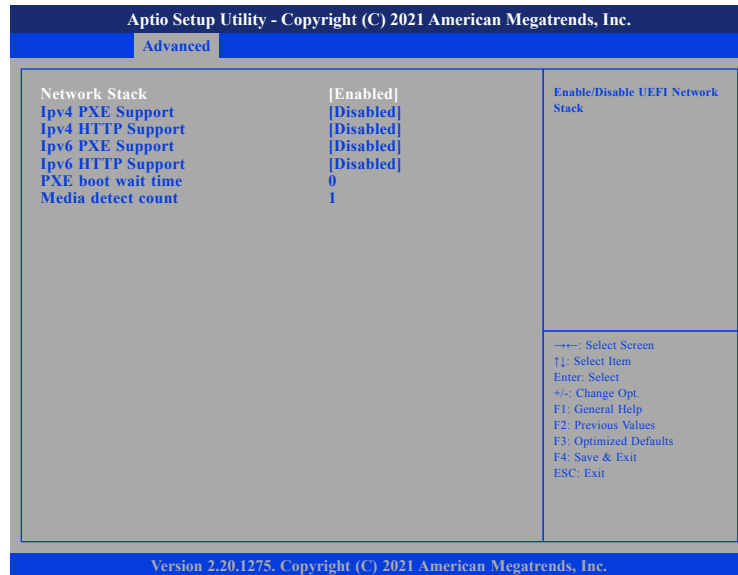

Network Stack

Enables or disables UEFI network stack.

Ipv4 PXE Support

Enables or disables IPv4 PXE support. If disabled, the IPv4 boot option will not be created.

Ipv4 HTTP Support

Enables or disables IPv4 HTTP support.

Ipv6 PXE Support

Enables or disables IPv6 PXE support. If disabled, the IPv6 boot option will not be created.

Ipv6 HTTP Support

Enables or disables IPv6 HTTP support.

PXE boot wait time

Configures the wait time to press the ESC key to abort the PXE boot.

Media detect count

Configures the number of times the media will be checked.

Intel(R) I210 Gigabit Network Connection - NIC

This section is used to configure network settings of the LAN controller.

Aptio Setup Utility - Copyright (C) 2021 American Megatrends, Inc.

Advanced

▶ NIC Configuration

Blink LEDs	0	Click to configure the network device port.
UEFI Driver	Intel(R) PRO/1000 8.7.08 PCI-E	
Adapter PBA	0003000-000	←→: Select Screen ↑↓: Select Item Enter: Select +/-: Change Opt. F1: General Help F2: Previous Values F3: Optimized Defaults F4: Save & Exit ESC: Exit
Device Name	Intel (R) I210 Gigabit Network Connection	
Chip Type	Intel i210	
PCI Device ID	1533	
PCI Address	03:00:00	
Link Status	[Disconnected]	
MAC Address	00:10:F3:83:50:C2	
Virtual MAC Address	00:00:00:00:00:00	

Version 2.20.1275. Copyright (C) 2021 American Megatrends, Inc.

NIC Configuration

Enters the network configuration sub-menu of the network controller.

Chipset

This section gives you functions to configure the system based on the specific features of the chipset. The chipset manages bus speeds and access to system memory resources.



Setting incorrect field values may cause the system to malfunction.

System Agent (SA) Configuration



Graphics Configuration

Enters the Graphics Configuration submenu.

PEG Port Configuration

Enters the PEG Port Configuration submenu.

Graphics Configuration

Aptio Setup Utility - Copyright (C) 2021 American Megatrends, Inc.		
Main	Advanced	Chipset
Graphics Configuration Primary Display [IGFX] Internal Graphics [Auto]		Select which of IGFX/PEG/PCI Graphics device should be Primary Display Or select SG for Switchable Gfx. →←: Select Screen ↑↓: Select Item Enter: Select +/-: Change Opt. F1: General Help F2: Previous Values F3: Optimized Defaults F4: Save & Exit ESC: Exit
Version 2.20.1275. Copyright (C) 2021 American Megatrends, Inc.		

Primary Display

Select which IGFX/PEG/PCI graphics device should be the primary display.

Internal Graphics

Keep IGD enabled based on the setup options.

PEG Port Configuration

Aptio Setup Utility - Copyright (C) 2021 American Megatrends, Inc.		
Main	Advanced	Chipset
PEG Port Configuration PEG 0:1:0 x0 Gen 1 Enable Root Port [Auto] Max Link Speed [Auto]		Enable or Disable the Root Port →←: Select Screen ↑↓: Select Item Enter: Select +/-: Change Opt. F1: General Help F2: Previous Values F3: Optimized Defaults F4: Save & Exit ESC: Exit
Version 2.20.1275. Copyright (C) 2021 American Megatrends, Inc.		

Enable Root Port

Enables or disables the root port.

Max Link Speed

Configures the maximum link speed of the PEG device.

PCH-IO Configuration

This section is used to configure PCH-IO configuration.



PCH LAN Controller

Enables or disables onboard NIC.

Wake on LAN

Enables or disables integrated LAN to wake the system.

State After G3

Configures the power state when power is re-applied after a power failure (G3 state).

SATA And RST Configuration



SATA Controller(s)

Enables or disables the SATA controller.

SATA Mode Selection

Configures the SATA as AHCI mode.

AHCI This option configures the Serial ATA drives to use AHCI (Advanced Host Controller Interface). AHCI allows the storage driver to enable the advanced Serial ATA features which will increase storage performance.

SATA Test Mode

Enables or disables SATA test mode.

HD Audio Configuration

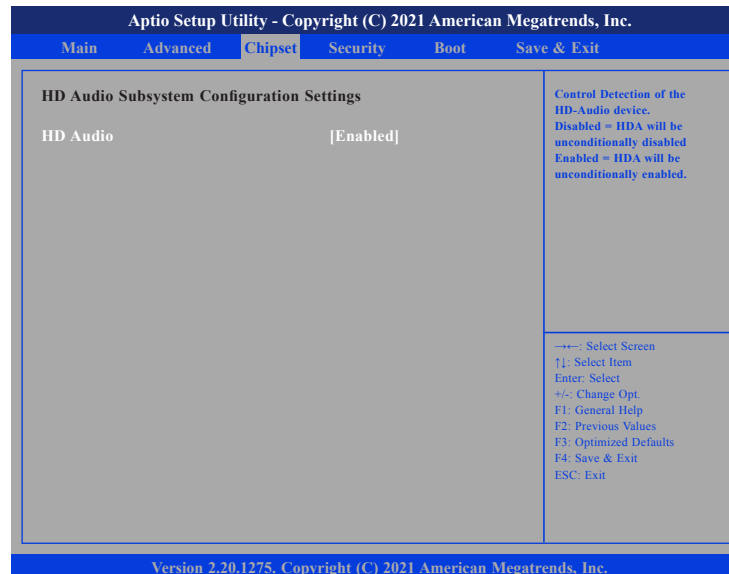

HD Audio

Control detection of the HD audio device.

- Disabled HD audio will be unconditionally disabled.
- Enabled HD audio will be unconditionally enabled.

EDID Mode Control

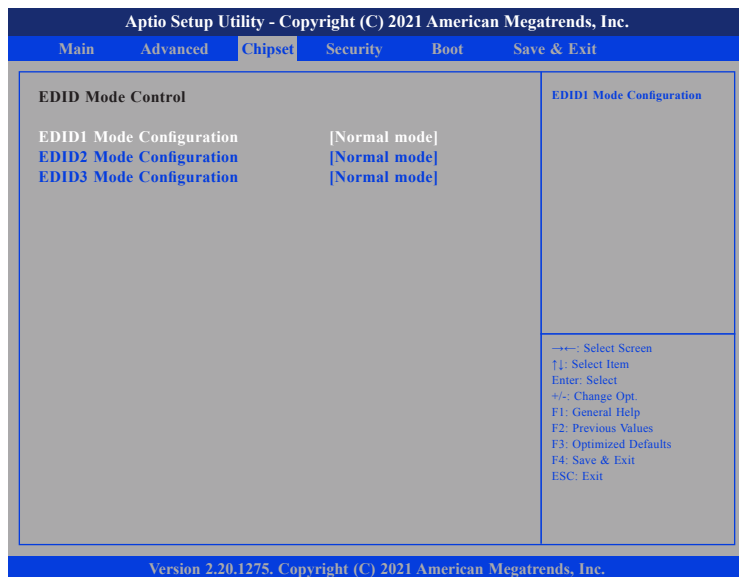

EDID1 to EDID3 Mode Configuration

Configures the EDID resolution for EDID1 to EDID3.

Security



Administrator Password

Select this to reconfigure the administrator's password.

User Password

Select this to reconfigure the user's password.

Boot

This section is used to configure the boot features.



Quiet Boot

Enabled Displays OEM logo instead of the POST messages.

Disabled Displays normal POST messages.

Boot Option Priorities

Adjust the boot sequence of the system. Boot Option #1 is the first boot device that the system will boot from, next will be #2 and so forth.

Setup Prompt Timeout

Selects the number of seconds to wait for the setup activation key.

65535(0xFFFF) denotes indefinite waiting.

Bootup NumLock State

This allows you to determine the default state of the numeric keypad. By default, the system boots up with NumLock on wherein the function of the numeric keypad is the number keys. When set to Off, the function of the numeric keypad is the arrow keys.

Save & Exit



Save Changes and Reset

To save the changes and exit the Setup utility, select this field then press <Enter>. A dialog box will appear. Confirm by selecting Yes. You can also press <F4> to save and exit Setup.

Discard Changes and Reset

To exit the Setup utility without saving the changes, select this field then press <Enter>. You may be prompted to confirm again before exiting. You can also press <ESC> to exit without saving the changes.

Restore Defaults

To restore the BIOS to default settings, select this field then press <Enter>. A dialog box will appear. Confirm by selecting Yes.

Save as User Defaults

To use the current configurations as user default settings for the BIOS, select this field then press <Enter>. A dialog box will appear. Confirm by selecting Yes.

Boot Override

To bypass the boot sequence from the Boot Option List and boot from a particular device, select the desired device and press <Enter>.