



# iKAN Series Display User Manual

V1.0.0, July 2019



**iKAN-116-PFB/iKAN-116S-PFB/iKAN-124-PFB/iKAN-124S-PFB**

**iKAN-208-PFB/iKAN-216-PFB/iKAN-224-PFB**

Written by Jimmy Huang

Edited by Tony Lee

## Warranty

---

All products manufactured by ICP DAS are under warranty regarding defective materials for a period of one year, beginning from the date of delivery to the original purchaser.

## Warning

---

ICP DAS assumes no liability for any damage resulting from the use of this product. ICP DAS reserves the right to change this manual at any time without notice. The information furnished by ICP DAS is believed to be accurate and reliable. However, no responsibility is assumed by ICP DAS for its use, not for any infringements of patents or other rights of third parties resulting from its use.

## Copyright

---

Copyright © 2019 by ICP DAS Co., Ltd. All rights are reserved.

## Trademark

---

The names used for identification only may be registered trademarks of their respective companies.

### Contact US

If you have any problem, please feel free to contact us.

You can count on us for quick response.

Email: [service@icpdas.com](mailto:service@icpdas.com)

# Contents

<b>Contents .....</b>	<b>3</b>
<b>1. Introduction.....</b>	<b>7</b>
<b>1.1. Features.....</b>	<b>9</b>
<b>1.2. Specification .....</b>	<b>12</b>
<b>1.3. Overview .....</b>	<b>16</b>
<b>1.4. Wire Connection .....</b>	<b>18</b>
<b>1.5. Dimension .....</b>	<b>21</b>
<b>2. Getting Started .....</b>	<b>25</b>
<b>2.1. Checking the Package .....</b>	<b>25</b>
<b>2.2. Assembling the iKAN .....</b>	<b>28</b>
2.2.1. One Piece of iKAN Display Installation.....	28
2.2.2. Two Pieces of iKAN Display Installation .....	29
2.2.3. Three Pieces of iKAN Display Installation.....	33
<b>2.3. Connecting to the Power, PC and PROFIBUS Master .....</b>	<b>38</b>
<b>2.4. Connecting the iKAN to a Network .....</b>	<b>41</b>
<b>2.5. PROFIBUS configuration .....</b>	<b>44</b>
<b>2.6. Editing Your First iKAN Message .....</b>	<b>52</b>
<b>3. Configuration.....</b>	<b>58</b>
<b>3.1. Web Interface .....</b>	<b>59</b>
3.1.1. Editing and Managing Messages.....	60
3.1.2. Applying the Variable Maps .....	61
3.1.2.1. Mapping Physical Values to Integer-Type Variables.....	63

3.1.2.2. Increasing the Decimal Places for the Number of Float-Type Variable .....	64
3.1.2.3. Assigning Strings to Coil Variables .....	65
3.1.3. Importing/Exporting pre-configured messages.....	66
3.1.3.1. Importing a configuration file .....	67
3.1.3.2. Exporting a configuration file.....	68
3.1.4. Changing the IP Address .....	69
3.1.5. Connecting to a remote DL-302 device .....	70
3.1.6. Setting the Serial Port .....	71
3.1.7. *Setting the Modbus ID .....	72
3.1.8. *Adjusting the LED Brightness .....	73
3.1.9. *Adjusting the Message Motion Speed .....	74
3.1.10. Restoring the Default Settings .....	75
3.1.11. Updating Date and Time .....	76
3.1.12. Resetting the Display.....	78
3.1.13. Checking the Firmware Information .....	79
<b>3.2. PROFIBUS configuration .....</b>	<b>81</b>
3.2.1. PROFIBUS wire connection. ....	82
3.2.2. GSD file.....	85
3.2.3. PROFIBUS device address .....	89
3.2.4. The configuration of the device parameters and the modules .....	92
3.2.5. Confirm the connection between IKAN-PFB and PROFIBUS master .....	96
3.2.6. The configuration of the control item.....	99
3.2.7. Diagnostic message.....	105
<b>3.3. eSearch Utility .....</b>	<b>106</b>
3.3.1. Configuring the IP Address.....	107
3.3.2. Sending the Modbus Command to iKAN .....	109

3.3.2.1. Using Modbus RTU Command to Configure the iKAN display.....	111
3.3.2.2. Using Modbus TCP Command to configure the iKAN display.....	113
<b>4. Message, LED Brightness, Message Motion and Speed .....</b>	<b>115</b>
<b>4.1. LED Brightness and Message motion speed .....</b>	<b>116</b>
4.1.1. Introduction .....	117
4.1.2. Adjusting LED Brightness and Message motion speed .....	118
<b>4.2. Message .....</b>	<b>121</b>
4.2.1. Editing and Managing Messages.....	122
4.2.2. Modify the message item through PROFIBUS master .....	125
4.2.3. Inserting System Variables into a Message.....	128
4.2.3.1. Displaying the IP Address.....	128
4.2.3.2. Displaying the Current Date and Time .....	131
4.2.3.3. Displaying the CO2 and Temperature Values from a Remote DL-302 Module.....	134
4.2.4. Inserting Integer-type Variables into a Message .....	136
4.2.5. Inserting float-type Variables into a Message.....	139
4.2.6. Inserting Coil –type Variables into a Message .....	142
4.2.7. Inserting ASCII Strings into a Message.....	145
<b>5. Writing Variables and DI, DO .....</b>	<b>148</b>
<b>5.1. Coil-type Variables .....</b>	<b>149</b>
5.1.1. Modify the value of Coil-type variables through PROFIBUS master.....	150
5.1.2. Displaying the Value of a Coil Variable with the Replacement Text .....	153
<b>5.2. Integer-type Variables .....</b>	<b>156</b>
5.2.1. Modify the value of Integer-type variables through PROFIBUS master .....	157
5.2.2. Displaying the Mapping Data for Integer-type Variables.....	159
<b>5.3. Float-type Variables .....</b>	<b>162</b>

5.3.1.	Modify the value of Float-type variables through PROFIBUS master .....	163
5.3.2.	Displaying the Number with Increased Decimal Places for Float-Type Variables..	165
<b>5.4.</b>	<b>DI, DO .....</b>	<b>167</b>
5.4.1.	Wire connection.....	168
5.4.2.	Read or Write the DI and DO channel through PROFIBUS master .....	169
<b>6.</b>	<b>iKAN Updates.....</b>	<b>172</b>
<b>Appendix A.</b>	<b>How to –.....</b>	<b>175</b>
A.1.	How to set iKAN Display in Modbus Configuration Mode .....	175
A.2.	How to set up the new Project in the PROFIBUS master software. (SIMATIC STEP7 in this example) .....	176
<b>Appendix B.</b>	<b>Variable Types and Modbus Register Map.....</b>	<b>180</b>
B.1.	Variable Types .....	180
B.2.	Modbus Register Map.....	181
<b>Appendix B.</b>	<b>Revision History .....</b>	<b>186</b>

# 1. Introduction

The iKAN series is a family of industrial Modbus LED display devices that deliver industrial-grade anti-noise capabilities as well as reliability and stability. The series display device is highly suitable for presenting formatted messages in indoor areas using either Unicode characters, which can be used to display multiple languages, or ASCII characters. Support for the popular Modbus industrial protocol is provided meaning that iKAN display devices can be easily integrated into existing PLC and SCADA environments.

168 variables are provided to allow data written from a PC or a PLC to be displayed in a formatted message in real-time. Seven colors are available for the text, which can be used to indicate different degrees of importance of the message, as well as significantly increase the readability of the message in an industrial arena.

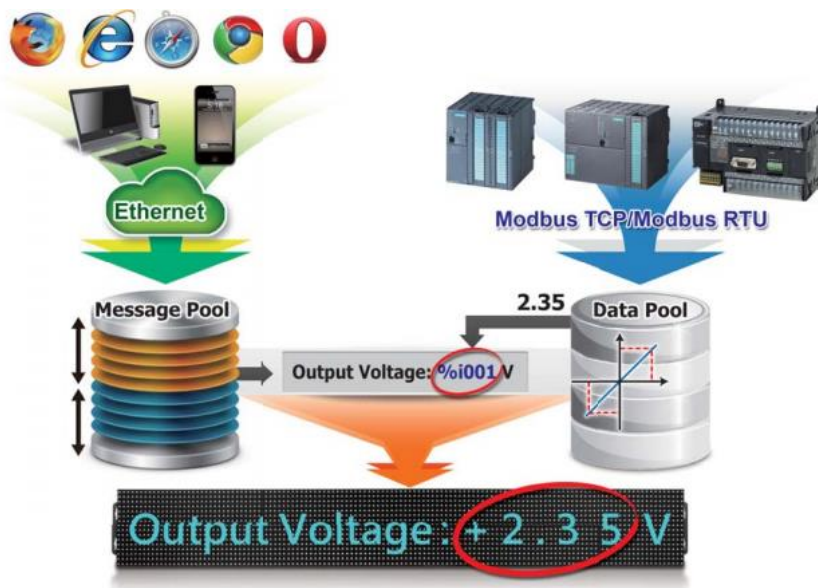

Messages can be edited using a standard web browser, such as Google Chrome, Firefox, or IE, etc., on a PC, mobile device, or smartphone without any limitations related to specific control tools or programs. The display of individual messages can also be remotely enabled or disabled as necessary using the same standard web browser. Each model in the iKAN series provides storage space for up to 64 common messages and 10 instant messages, each containing a maximum of 40 Unicode characters or 100 ASCII characters. With an open user interface and the ability to display real-time data, the iKAN series display can be installed in a variety of indoor spaces, including

shopping malls, railway stations, and industrial areas.



## 1.1. Features

The following is a brief summary of features and capabilities in iKAN displays.

### PLC HMI

The iKAN series can be employed as a large HMI with a memory storage of up to 64 common messages and 10 instant messages, each of which can be used to display information generated by a PLC. Message text can be displayed in a range of seven colors, including red, blue, yellow, green, light blue, purple, and white, which can be used to indicate warnings or alarms, as well as increasing the readability of a message.



Voltage: 2.35 V



Machine A01: Active



02: 725 PPM

### Supports Multiple Languages

The iKAN series of display device supports Unicode input, meaning that messages can be configured to be displayed in multiple languages.

### Message Editing

A maximum of 64 common messages and 10 instant messages can be preconfigured from the first moment that the iKAN series display is switched on. When the display is in operation, the focus needs only be on message management rather than the need to frequently update the messages.

## **Message Priority**

Instant messages have a higher priority than common messages. Once an instant message is enabled, the common message currently being displayed will be suspended until the instant message is disabled. This feature allows the most important information to be displayed in an emergency situation.

## **Integer-type variables enable data mapping**

The iKAN series of display devices provide the ability to perform data mapping to translate a computer integer value to a readable physical value, such as the voltage, temperature, or relative humidity, etc. In the industrial field, this is a commonly performed task between the host computer and the data-acquisition devices via the Modbus protocol, enabling a reduction in the resources and programming required for the host computer

## **Import/Export the message configuration**

The iKAN series allows a message and the parameters of the variables to be saved as a configuration file, which can then be loaded onto another iKAN series device to avoid the need to repeat the configuration.

## **Smartphone Application**

Users can manage messages via a regular smartphone without requirement of a specific connection device, meaning that emergency information can be quickly sent to the display using the smartphone.



## 1.2. Specification

The table below summarizes the specifications of the iKAN series of displays.

### iKAN-116-PFB/iKAN-116S-PFB/iKAN-124-PFB/iKAN-124S-PFB

Model	iKAN-116-PFB	iKAN-116S-PFB	iKAN-124-PFB	iKAN-124S-PFB
<b>Display</b>				
Color	Red, Blue, Yellow, Green, Light Blue, Purple or White			
Character Set	16-bit Unicode or 7-bit ASCII			
Display Size	ASCII	16 characters	24 characters	
	Unicode	8 characters	12 characters	
Message Pool	64 common messages and 10 instant messages Up to 40 Unicode characters or 100 ASCII characters each			
Data Pool	40 Coil values, 64 Float values, and 64 Integer values			
RTC (Real-time Clock)	Date and time, 24 hour format, including hours, minutes, seconds, day of the week, date, month, year			
<b>Ethernet</b>				
Port	1 x RJ-45, 10/100 Base-TX			
Protocol	Modbus TCP Slave, Max. 8 connections			
Configuration	Web-based User Interface			
<b>PROFIBUS</b>				
Controller	Profichip VPC3+C			
Transceiver	ADI ADM2486			
Connector	9-pin female D-Sub			
Baud Rate(bps)	9.6k, 19.2k, 45.45k, 93.75k, 187.5k, 500k, 1.5M, 3M, 6M, 12M			
Transmission Distance(m)	Depend on baud rate(for example, max. 1200m at 9.6kbps)			
Isolation	3000 VDC for DC-to-DC, 2500 Vrms for bus-to-logic			
Protocol	DP-V0 & DP-V1			
<b>COM Port</b>				

Interface	RS-232 or RS-485. Note that the interfaces cannot be used simultaneously			
Baud rate (bps)	1200, 2400, 4800, 9600, 19200, 38400, 57600, 115200			
Data Format	N81, E81, O81			
Protocol	Modbus RTU Slave			
<b>Power</b>				
Input Range	100 to 240 VAC			
Consumption	0.25 A @ 110 VAC, 0.125 A @ 220 VAC		0.3A A @ 110 VAC, 0.15 A @ 220 VAC	
<b>Mechanical</b>				
Dimensions (W x H x D, unit: mm)	1346 x 160 x 49	835 x 115 x 37.5	1986 x 160 x 49	1218 x 115 x 37.5
<b>Mechanical</b>				
Weight	4.0 Kg	2.0 Kg	4.6 Kg	2.5 Kg
Installation	Wall mounting			
Housing Material	Aluminum			
<b>Environment</b>				
Operating Temperature	0 to 60°C			
Storage Temperature	-10 to 75°C			
Humidity	10 to 90% RH, Non-condensing			

### iKAN-208-PFB/iKAN-216-PFB/iKAN-224-PFB

Model		iKAN-208-PFB	iKAN-216-PFB	iKAN-224-PFB
<b>Display</b>				
Color		Red, Blue, Yellow, Green, Light Blue, Purple or White		
Character Set		16-bit Unicode or 7-bit ASCII		
Display Size	ASCII	8 characters	16 characters	24 characters
	Unicode	4 characters	8 characters	12 characters
Message Pool		128 common messages and 20 instant messages Up to 20 Unicode characters or 50 ASCII characters each		
Data Pool		40 Coil values, 64 Float values, and 64 Integer values		

RTC (Real-time Clock)	Date and time, 24 hour format, including hours, minutes, seconds, day of the week, date, month, year		
<b>Ethernet</b>			
Port	2 x RJ-45, 10/100 Base-TX		
Protocol	Modbus TCP Slave, Max. 8 connections		
Configuration	Web-based User Interface		
<b>PROFIBUS</b>			
Controller	Profichip VPC3+C		
Transceiver	ADI ADM2486		
Connector	9-pin female D-Sub		
Baud Rate(bps)	9.6k, 19.2k, 45.45k, 93.75k, 187.5k, 500k, 1.5M, 3M, 6M, 12M		
Transmission Distance(m)	Depend on baud rate(for example, max. 1200m at 9.6kbps)		
Isolation	3000 VDC for DC-to-DC, 2500 Vrms for bus-to-logic		
Protocol	DP-V0 & DP-V1		
<b>COM Port</b>			
Interface	RS-232 x 1 or RS-485 x 2. Note that the interfaces cannot be used simultaneously		
Baud rate (bps)	1200, 2400, 4800, 9600, 19200, 38400, 57600, 115200		
Data Format	N81, E81, O81		
Protocol	Modbus RTU Slave		
<b>Power</b>			
Input Range	100 to 240 VAC		
Consumption			
<b>Mechanical</b>			
Dimensions (W x H x D, unit: mm)	707 x 320 x 50	1346 x 160 x 49	1986 x 160 x 49
Weight	4 Kg	8 Kg	12 Kg
Installation	Wall mounting		
Housing Material	Aluminum		
<b>Environment</b>			
Operating Temperature	0 to 60°C		
Storage Temperature	-10 to 75°C		

Humidity	10 to 90% RH, Non-condensing
----------	------------------------------

## 1.3. Overview

The iKAN series display is equipped with several interfaces and peripherals that can be integrated with external systems. Here is an overview of the components and its descriptions.

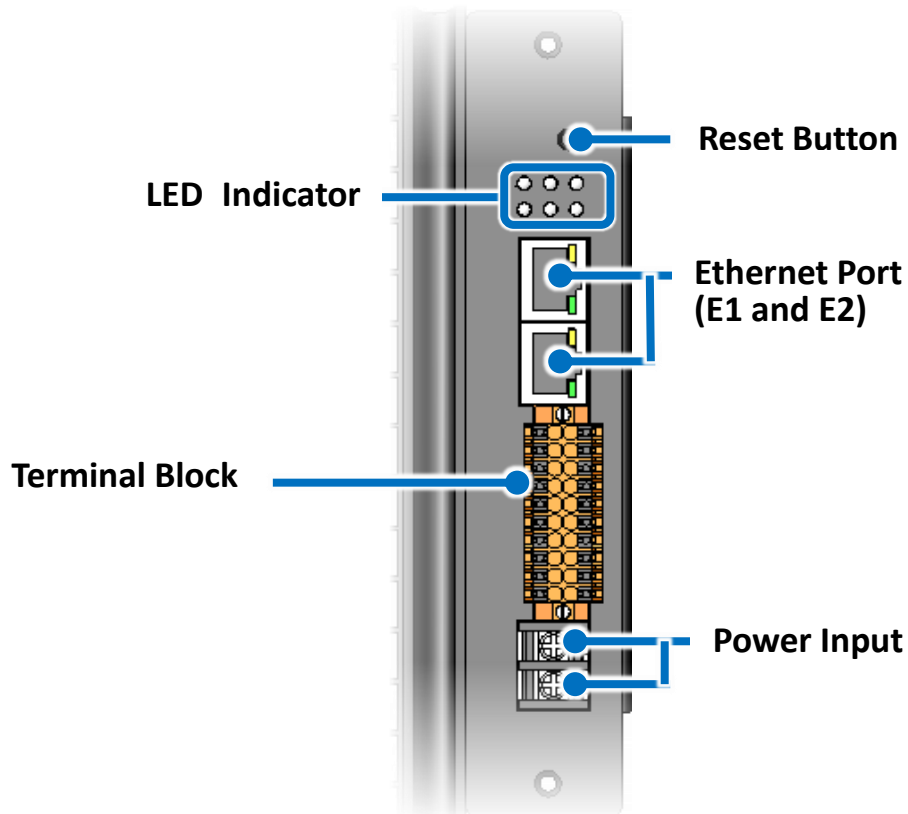

The details of these items are as follows:

- **Reset Button**

The reset button is used to restore all settings to factory defaults. It is very useful especially when you forget the IP address to access the iKAN series display.

- **LED Indicator**

LED Indicator/Label	State	Meaning
PWR	Green	Power is on.
	Orange	OS is running.
Reset		



DI0, DI1, DO0, DO1	Green	The LED indicators are used to indicate the status of digital I/O.
--------------------	-------	--

● **Ethernet Port (E1 and E2)**

The iKAN series display has two Ethernet ports that can be used to connect the router to the Internet or to other devices.

Each Ethernet port has two LED indicators that display the status of the iKAN series display. The details are shown as below.

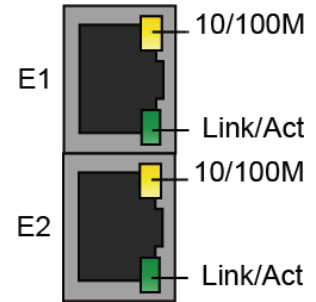

LED Indicator/Label	Label	State	Meaning
E1、 E2	10/100M	Orange	Network Speed: 100 M
		-	Network Speed: 10 M
	Link/Act	Green	The Link is active.
		-	The Link is inactive.
		Green-Blinking	Network activity.

● **Terminal Block**

The iKAN series display has a terminal block. The label contents for the terminal block with 20 poles are shown below. For identification of wiring connections, please refer to section “1.4. Wire Connections”

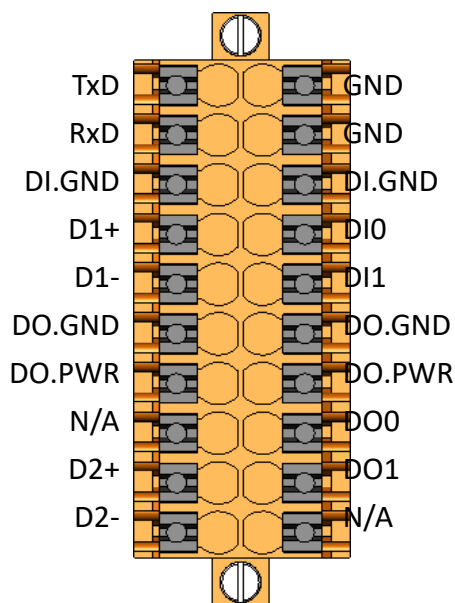

## 1.4. Wire Connection

The iKAN series display has a terminal block which supports several communications. The following figures show the wiring information for the terminal block.

### RS-232 Wiring

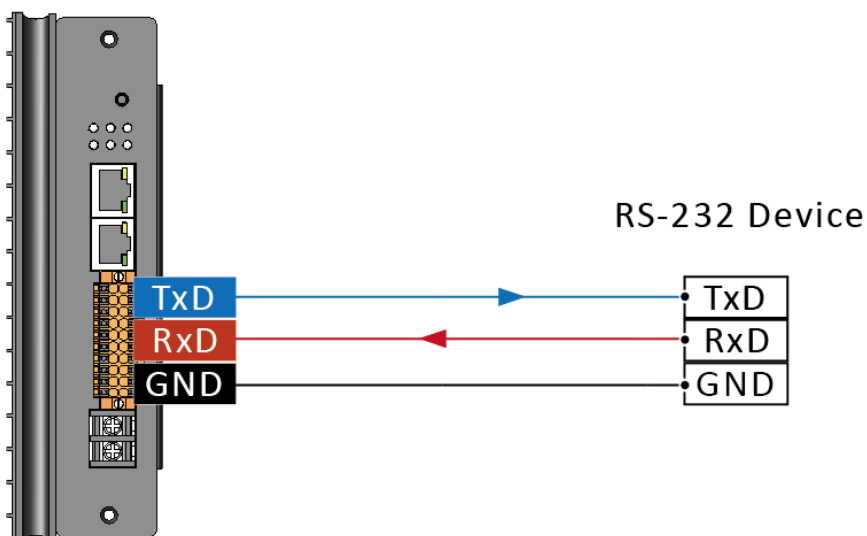

### RS-485 Wiring

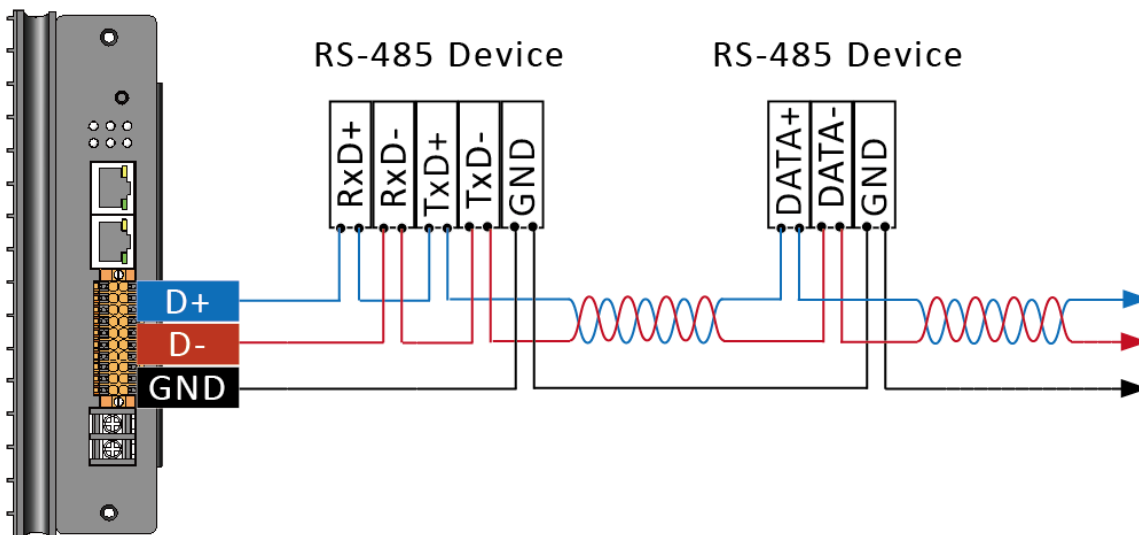

## DI Wiring

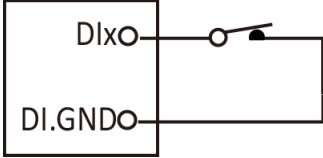
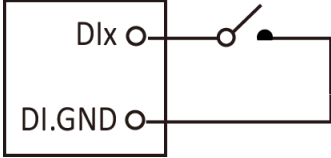
Input Type	On State as 0	OFF State as 1
Dry Contact	Close to GND	Open
		

## DO Wiring

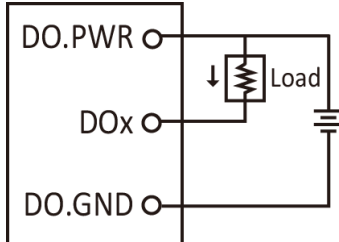
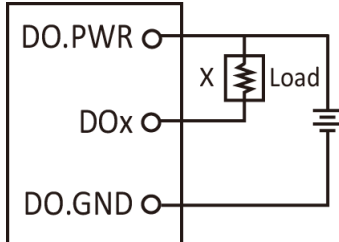
Input Type	On State Readback as 1	OFF State Readback as 0
DO (Sink, NPN)	+5 to +24 VDC	Open
		



## 1.5. Dimension

The diagrams below provide details of the dimensions for the iKAN series of displays that can be used when defining the specifications for any enclosures to be installed. All dimensions are in millimeters.

### iKAN-116S

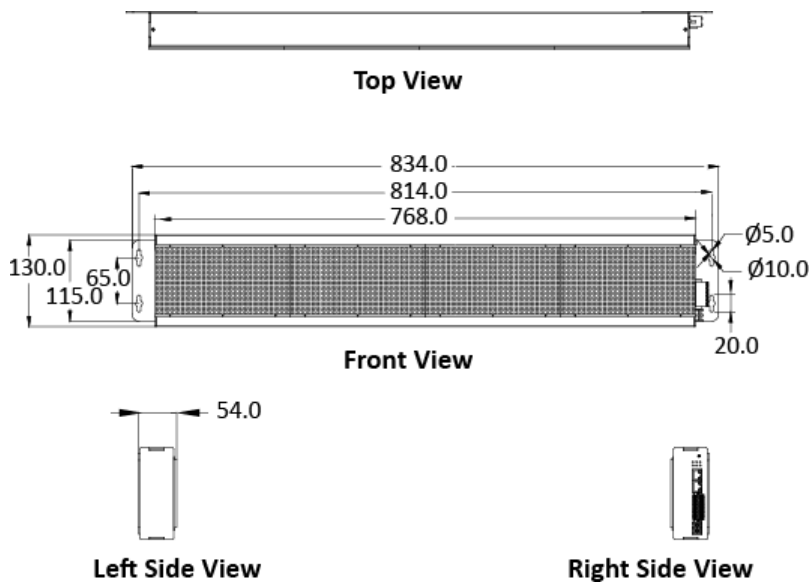

### iKAN-124S

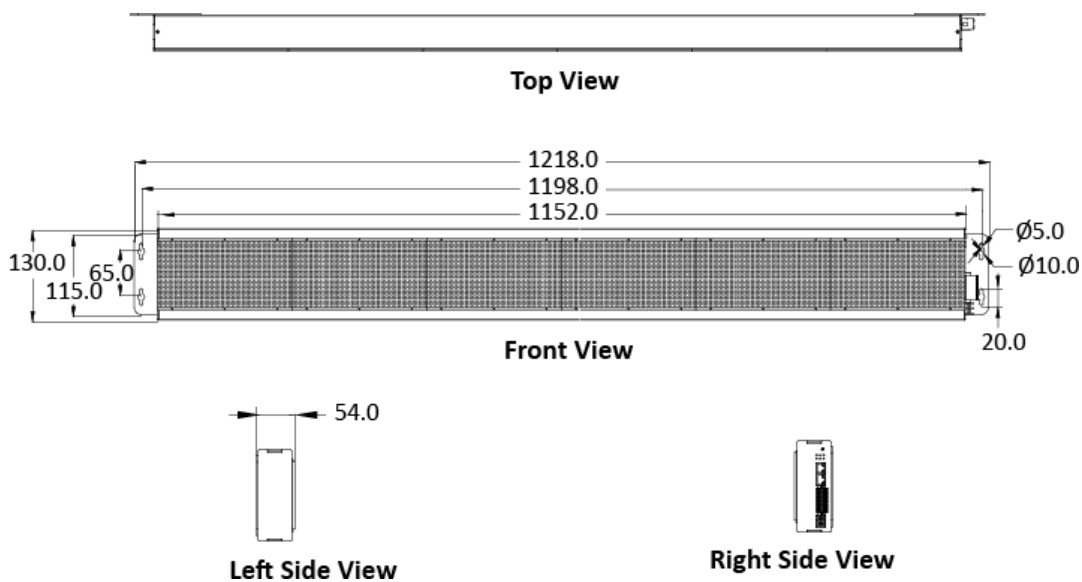

### iKAN-116

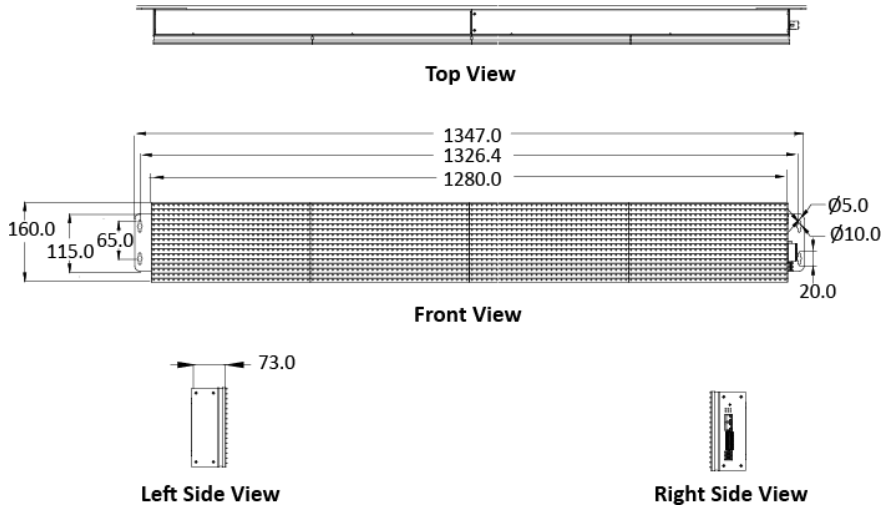

### iKAN-124

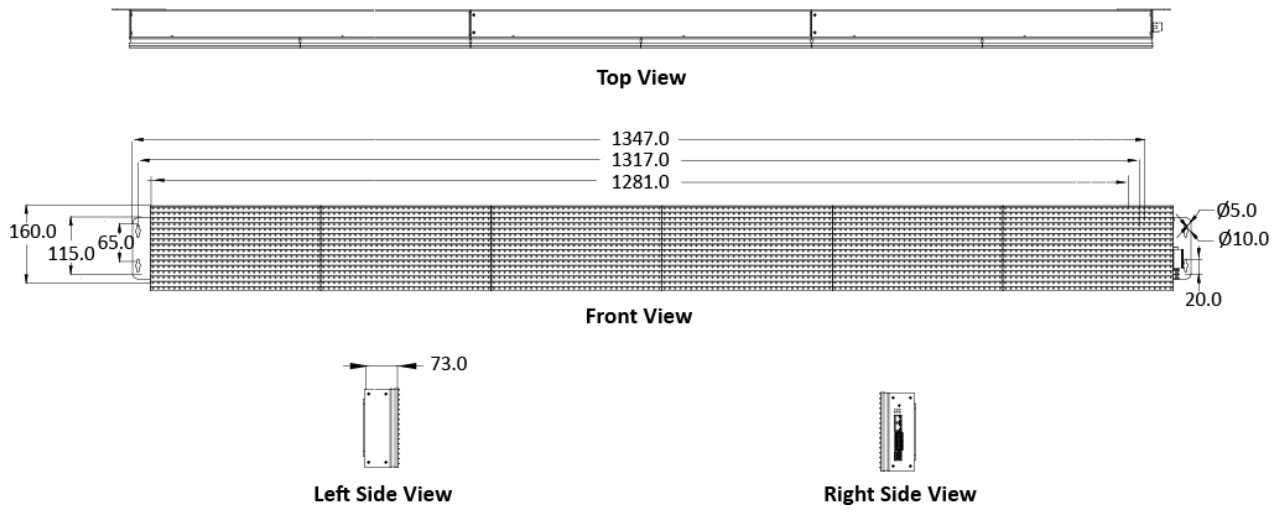

**iKAN-208**

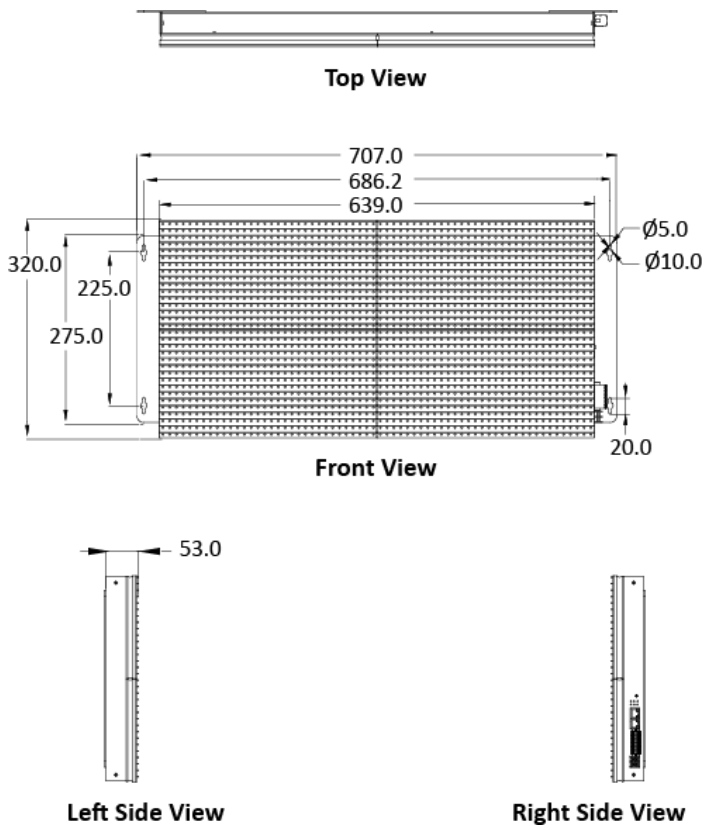

**iKAN-216**

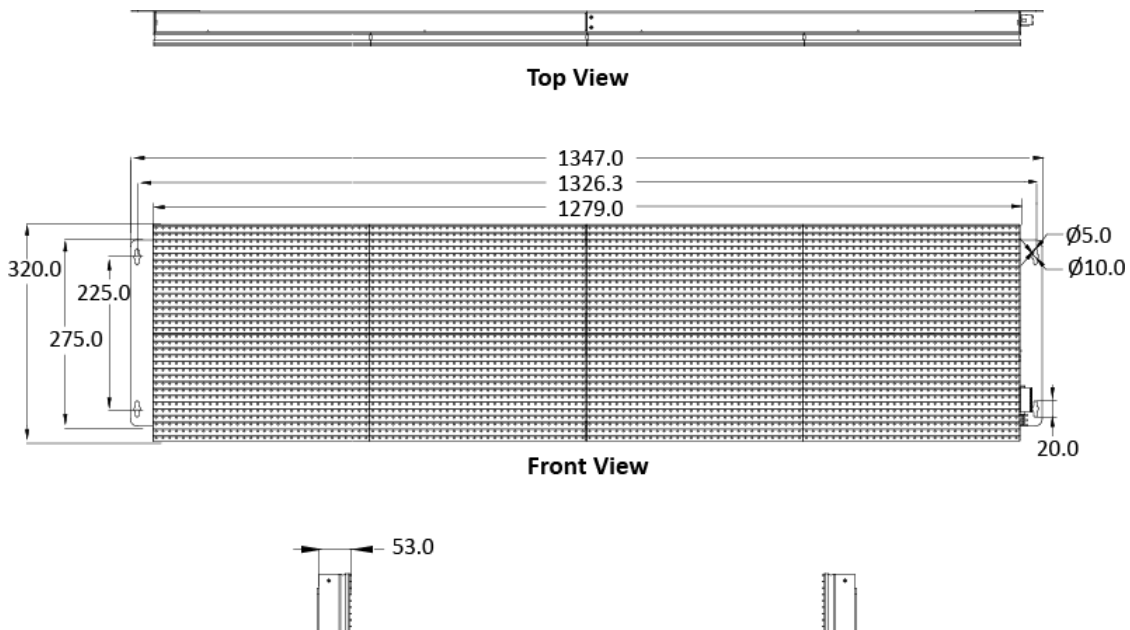

**iKAN-224**

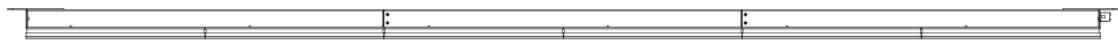

**Top View**

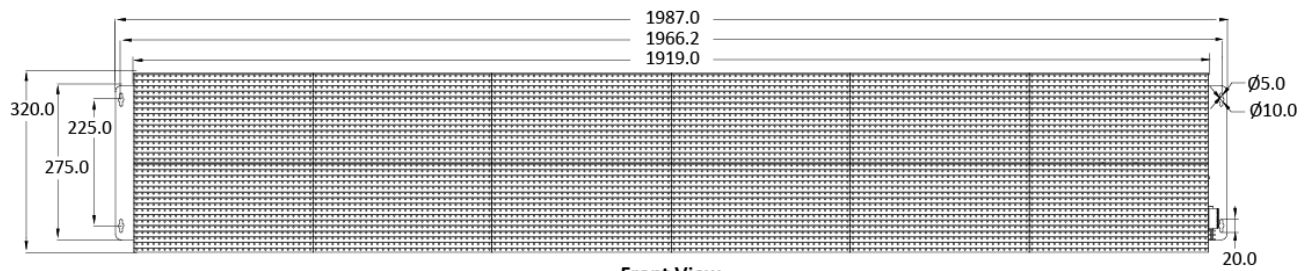

**Front View**

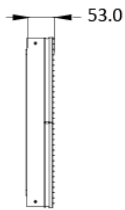

**Left Side View**



**Right Side View**



## 2. Getting Started

If you are new to iKAN, you should read this chapter first. This chapter provides a description of the basic procedures that need to be followed when installing, configuring, and activating the iKAN system, before operating the iKAN for the first time.

### 2.1. Checking the Package

Before starting any task, check the contents of the shipping package. If any of the following items are missing or damaged, contact your dealer or distributor.

For one piece of iKAN display: iKAN-116S, iKAN-124S and iKAN-208



One piece of iKAN Display  
iKAN-116S/iKAN-124S

Quick Start Guide

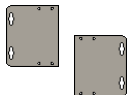

Wall Mounting Kit \* 2



Screw Driver



M3x6L Screw

iKAN-116S/iKAN-124S: Screw \*

8

iKAN-208: Screw \*16

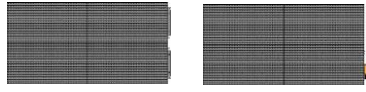

Two pieces of iKAN Display

**iKAN-116/iKAN-216**

**Quick Start Guide**

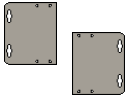

**Wall Mounting Kit \* 2**



**Screw Driver**



**M3x6L Screw**

iKAN-116: Screw \* 14

iKAN-216: Screw \* 24

**For two pieces of iKAN display: iKAN-116 and iKAN-216**

**For three pieces of iKAN display: iKAN-124 and iKAN-224**

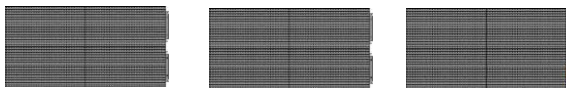

Three pieces of iKAN Display

**iKAN-116S/iKAN-124S**

**Quick Start Guide**

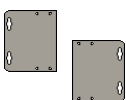

**Wall Mounting Kit \* 2**



**Screw Driver**



**M3x6L Screw**

iKAN-124: Screw \* 20

iKAN-224: Screw \* 32

## 2.2. Assembling the iKAN

Before installation, make sure that surface dedicated for installation is suitable to support weight of given device. We do not recommend soft and fragile surfaces, such as polystyrene foam, mineral wool, plaster boards and wooden walls with a thickness of less than 30mm, etc.

### 2.2.1. One Piece of iKAN Display Installation

Fasten the left and right mounting plates to the iKAN display with 8/16 supplied screws each side.

#### iKAN-116S/iKAN-124

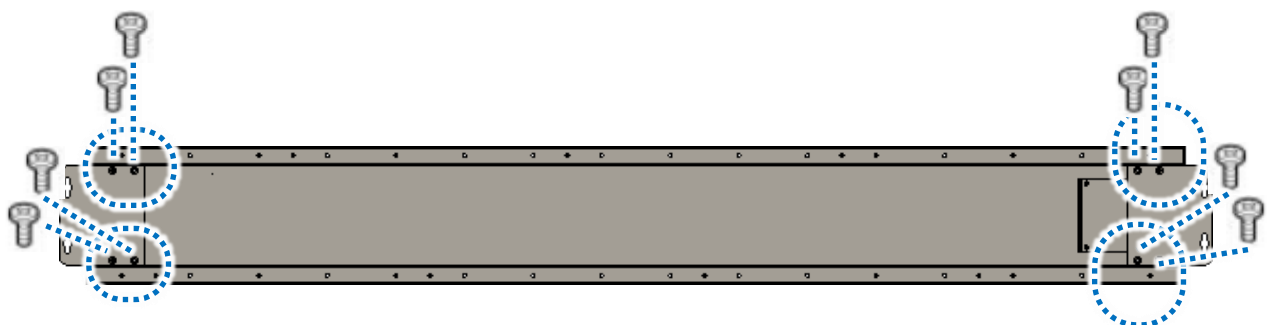

#### iKAN-208

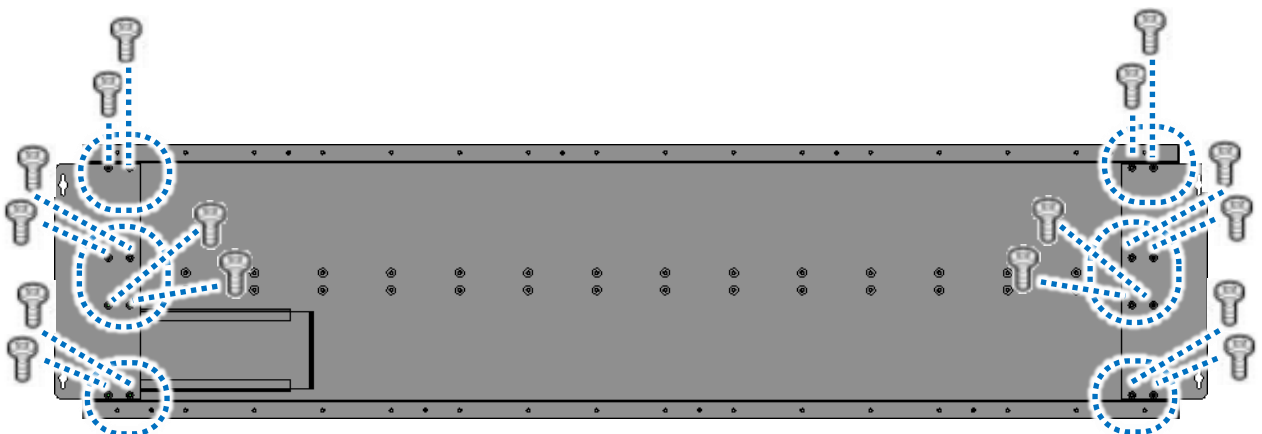

## 2.2.2. Two Pieces of iKAN Display Installation

iKAN-116 and iKAN-216 consists of 2 modules: left end module and right end module. Each row of the module has two connectors for connecting the iKAN display.

1. Pull out the connectors from the opening of the side

Left end module

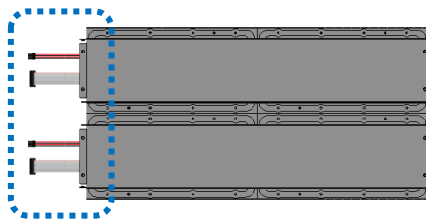

Right end module

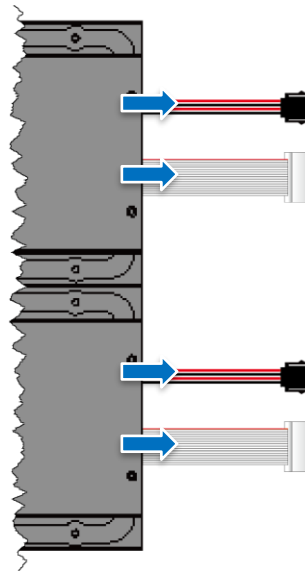
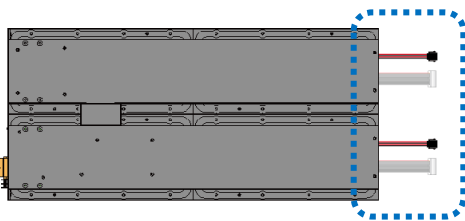

2. Connect the connectors

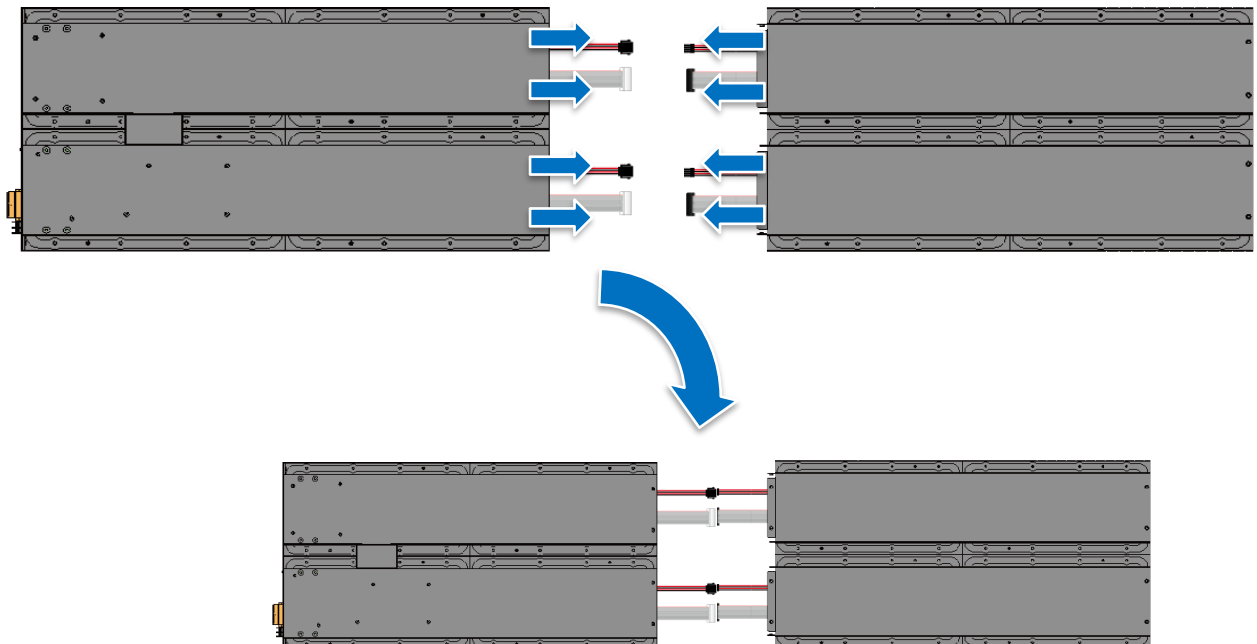

3. Attach the modules and fasten the modules together with 6/8 supplied screws

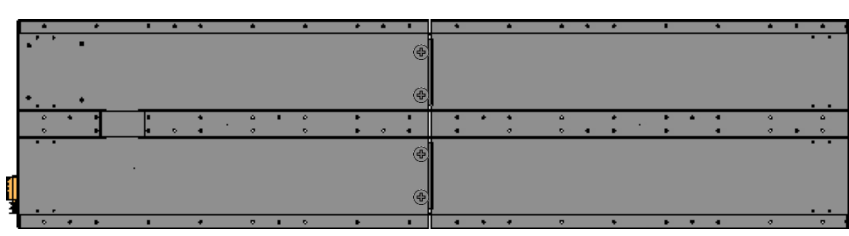
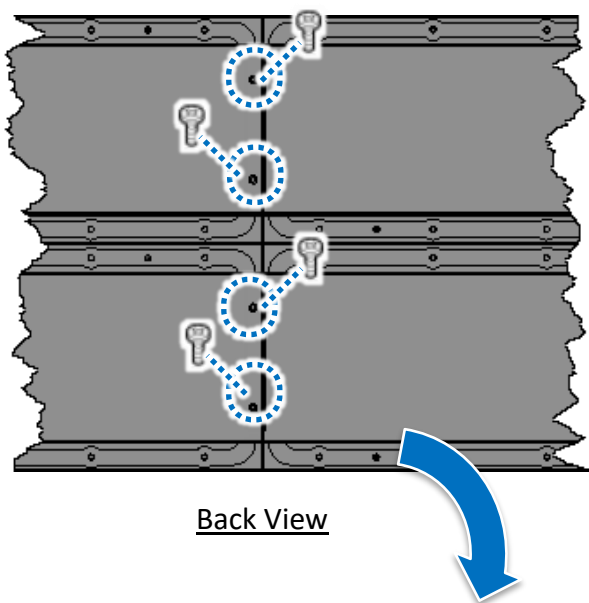
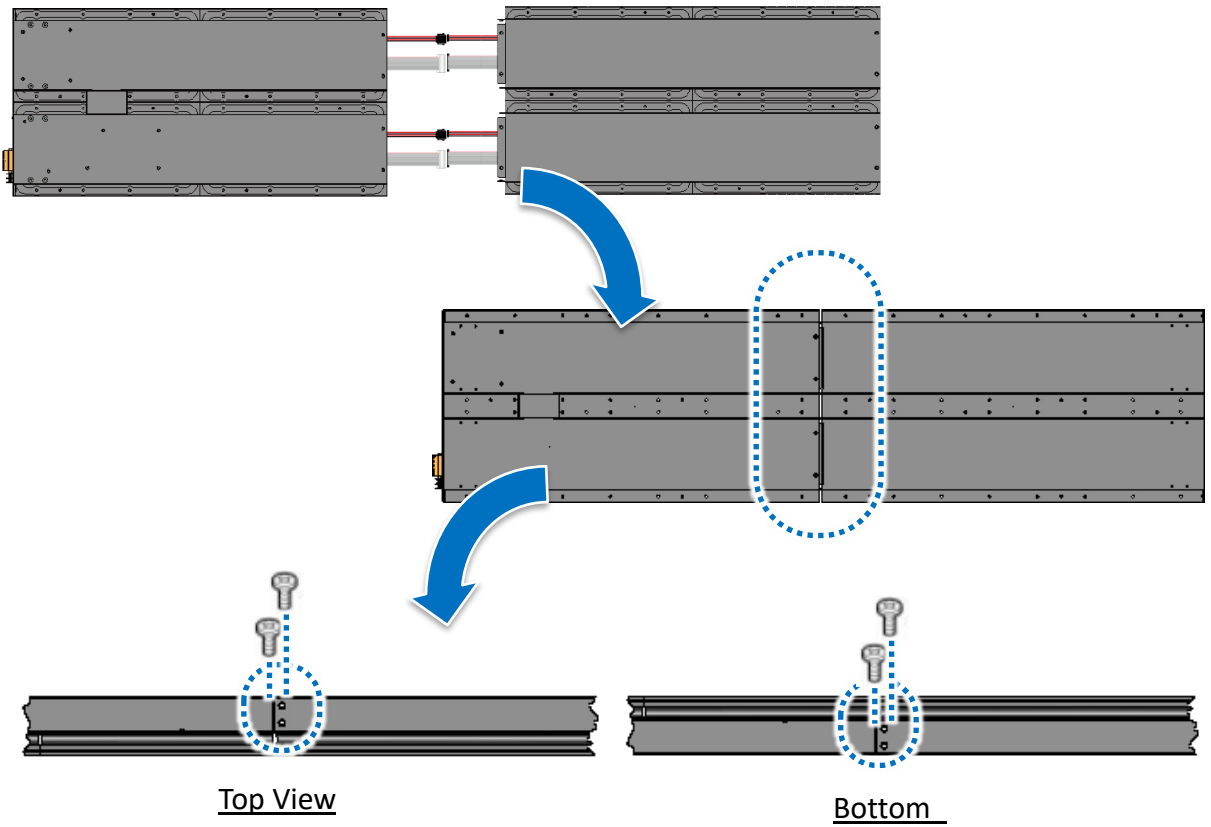

4. Fasten the left and right mounting plates to the iKAN display with 8/16 supplied screws each side.

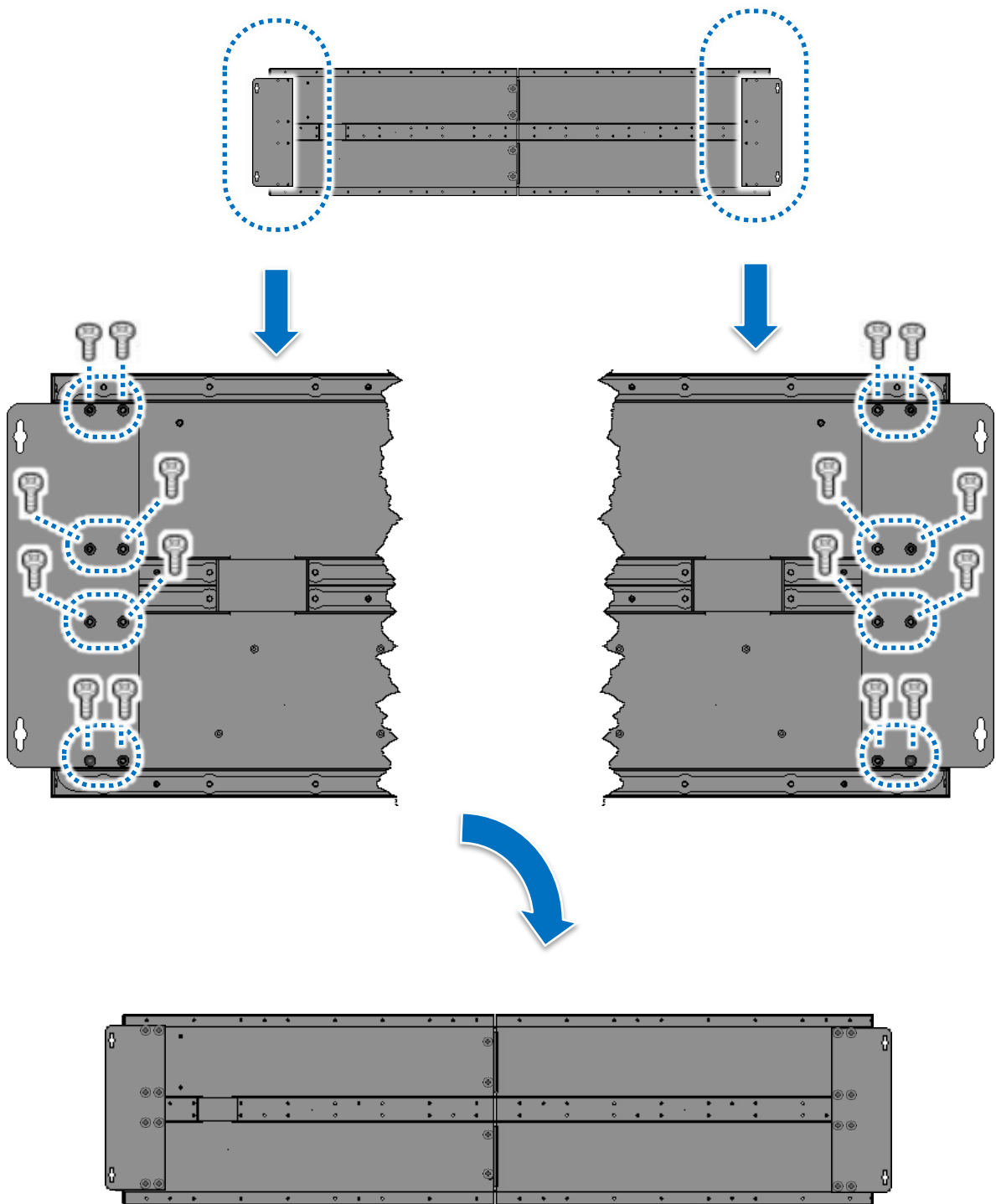





### 2.2.3. Three Pieces of iKAN Display Installation

iKAN-124 and iKAN-224 consists of 3 modules: left end module, middle module and right end module. Each row of the module has two connectors for connecting the iKAN display.

1. Pull out the connectors from the opening of the side

Left end module

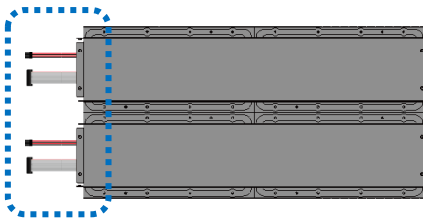

middle module

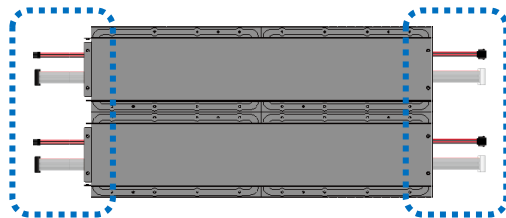

Right end module

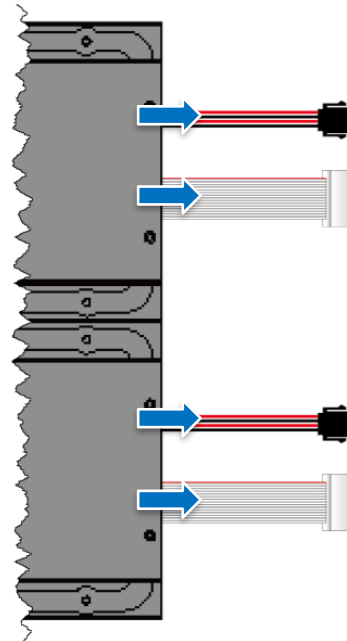
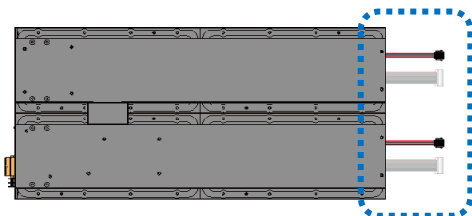

2. Connect the connectors and attach the modules

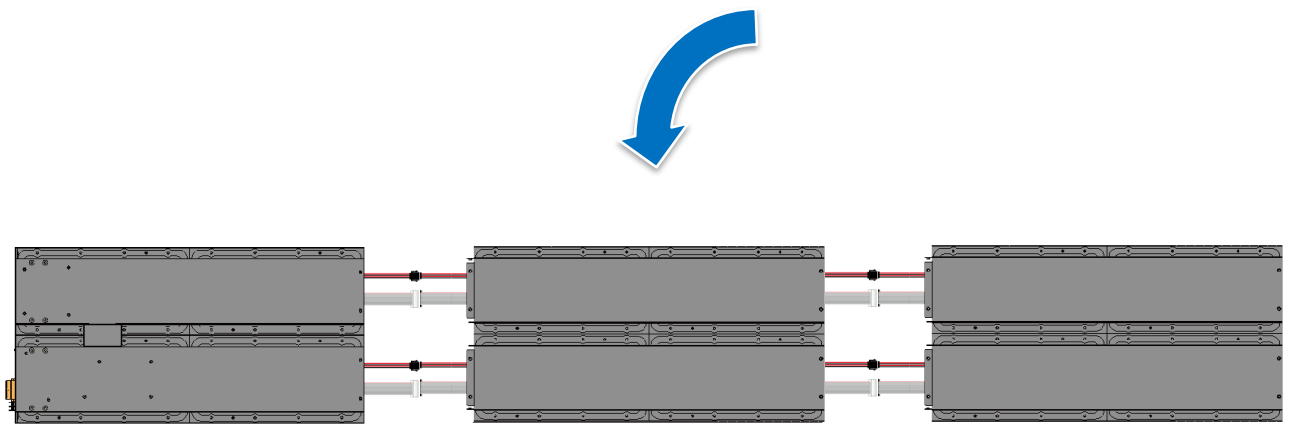
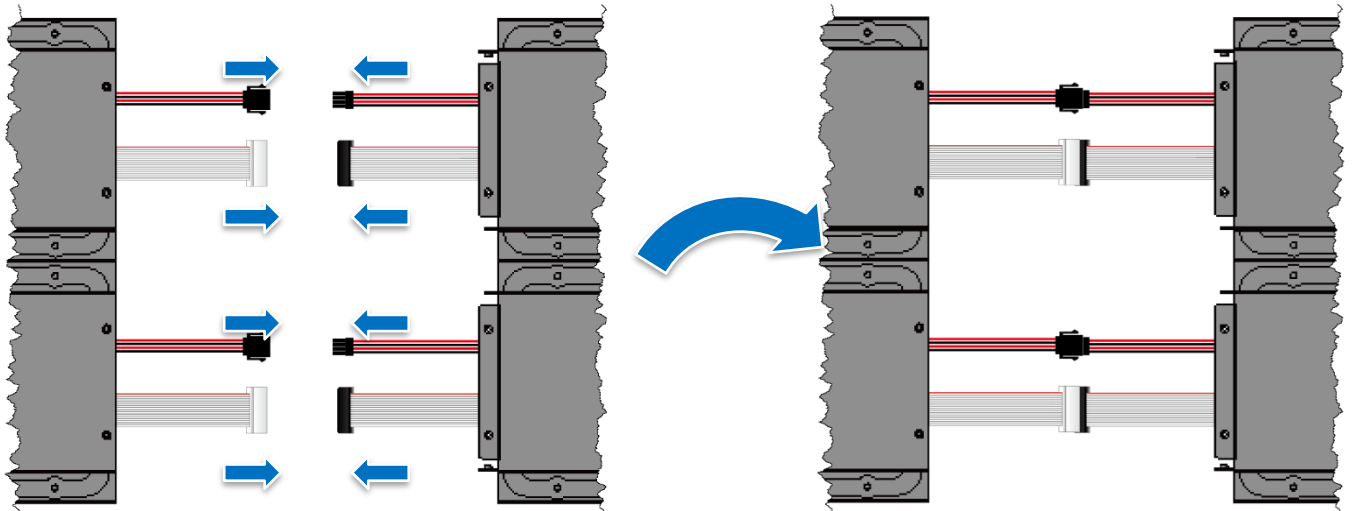

Right End Module

Middle Module

Left End Module

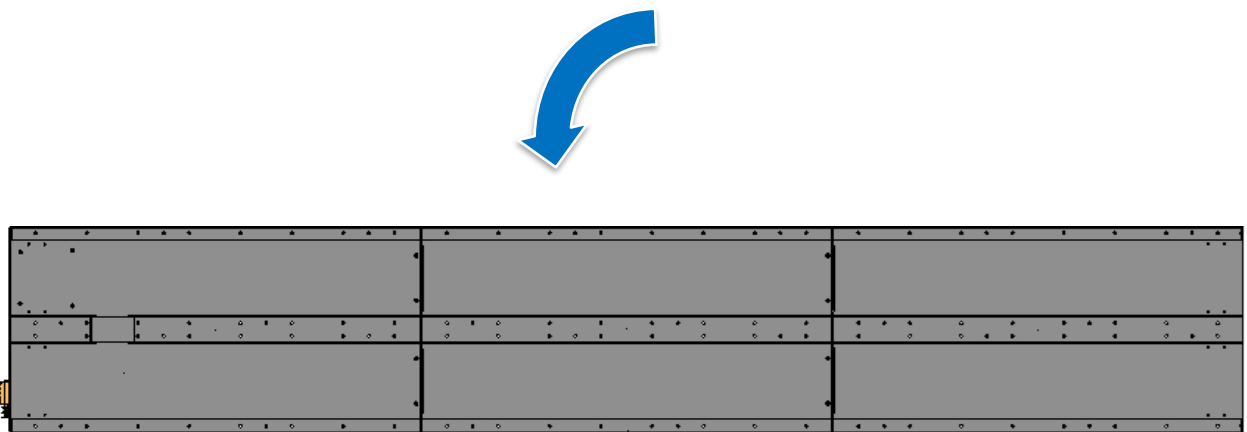

3. Fasten the modules together with 6/8 supplied screws

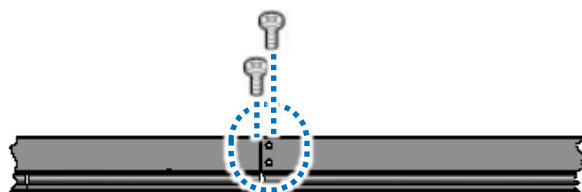
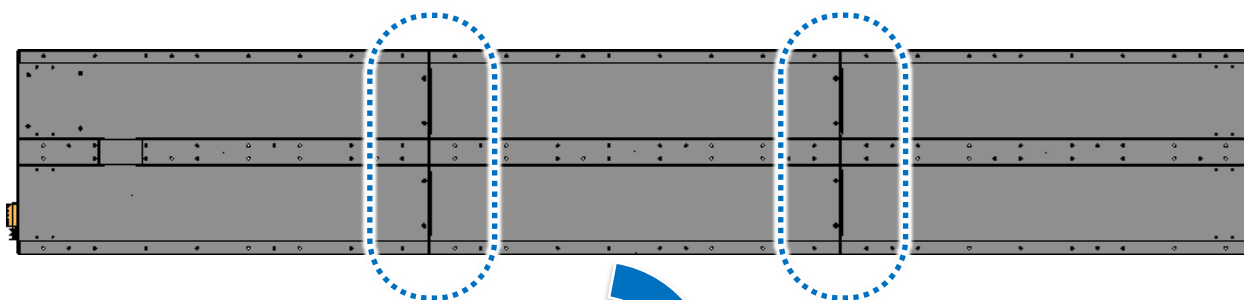

Top View

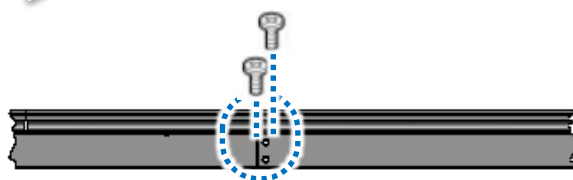

Bottom

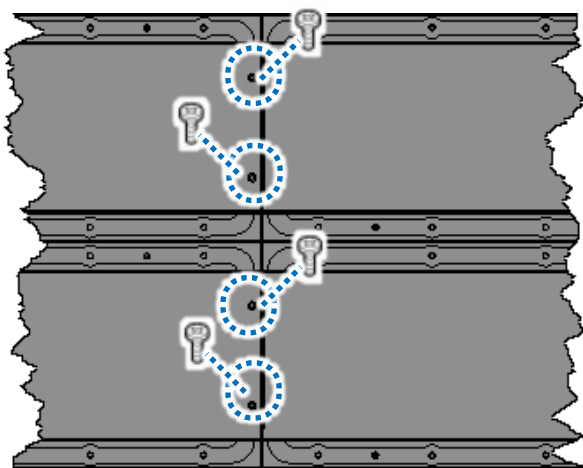

Back View



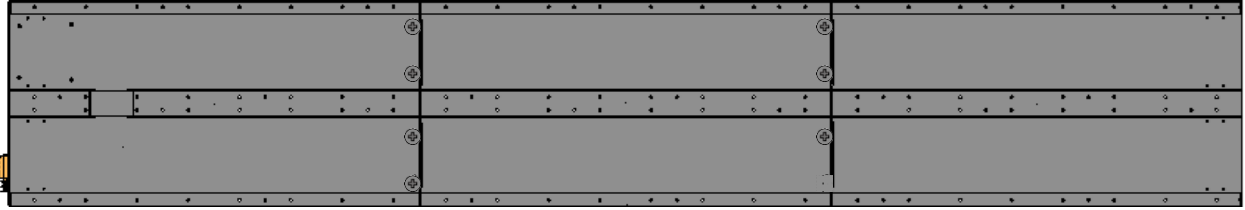

4. Fasten the left and right mounting plates to the iKAN display with 8/16 supplied screws each side.

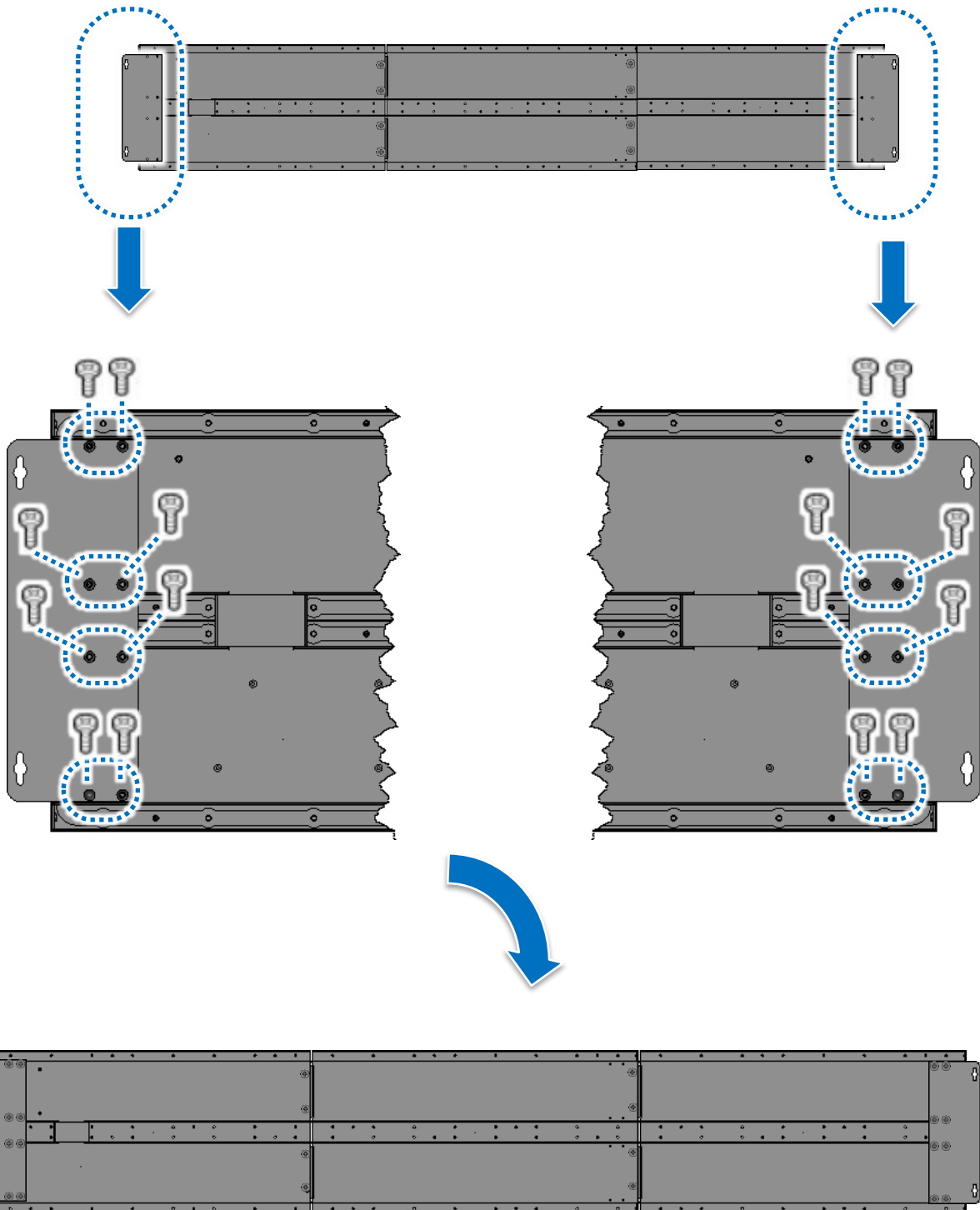



## 2.3. Connecting to the Power, PC and PROFIBUS Master

The iKAN display has two standard Ethernet ports (RJ-45) which provide access to the iKAN with a PC. To configure the iKAN through the PC, you must establish a connection between the iKAN and a PC.

### 1. Connect the power to the iKAN

- i. Verify that input power to the external power supply is turned off.
- ii. Connect a 240 VAC+ terminal on the power supply to the Vs+ terminal on the iKAN
- iii. Connect a 240 VAC- terminal on the power supply to the GND terminal on the iKAN

### 2. Connect the Ethernet cable to the printer port, and then connect the other end of the cable to an available port on the network router, switch, or hub

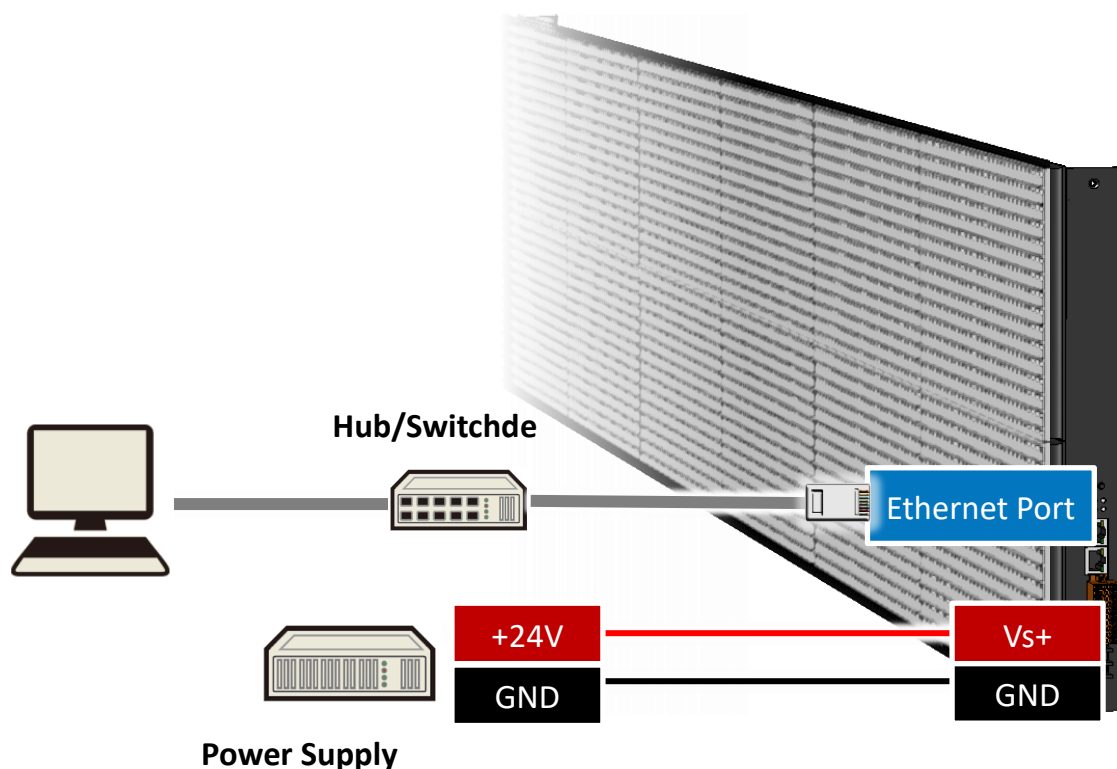

### 3. PROFIBUS Connection

The PROFIBUS interface of IKAN-PFB is a D-sub 9 pin female connector. Use the standard connector (D-sub 9 pin male) to connect the connector of IKAN-PFB display, IKAN-PFB display can connect other PROFIBUS devices through PROFIBUS cable, as the shown in the below.

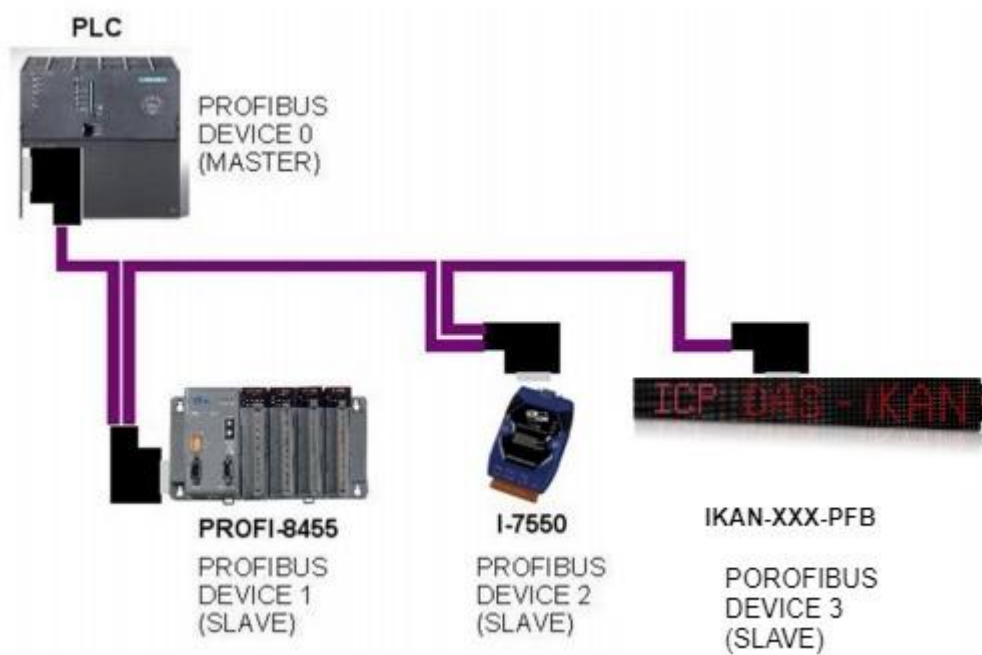

If IKAN-PFB is the end (first or last node) of a PROFIBUS segment, it needs to be install equipped with an active terminal resistor. A standard PROFIBUS connector is usually already equipped with a terminal resistor. Therefore, the user only needs to switch on the terminal resistor when the IKAN-PFB display is the end of a PROFIBUS segment, as shown in the below.

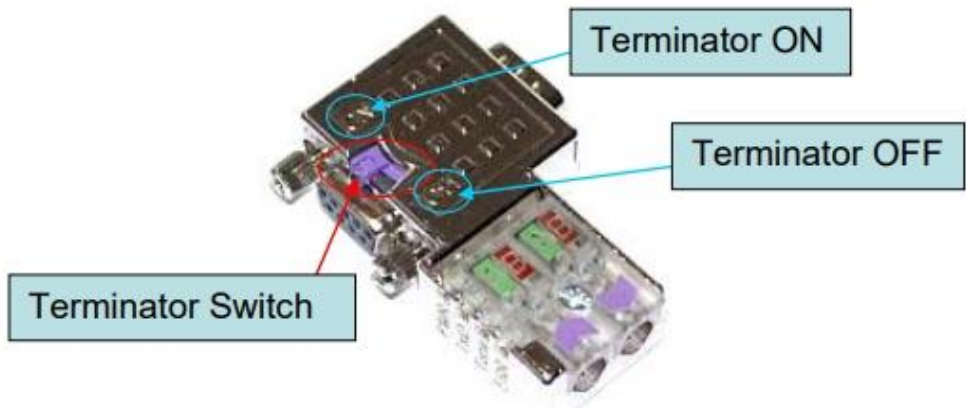



## 2.4. Connecting the iKAN to a Network

The factory default IP address for each iKAN device is **192.168.255.1**.

Before integrating an iKAN series display into your network, you should configure the IP, Mask, and Gateway addresses for the device by setting the values that are valid for your network system.

The eSearch Utility is developed for searching ICP DAS Ethernet I/O modules based-on MiniOS7 which are connected to the same subnetwork as the Host PC, configuring the Ethernet parameters such as IP address, subnet mask and gateway etc., or updating firmware.

1. Get the latest version of the eSearch Utility



The eSearch Utility can be obtained from:

<http://ftp.icpdas.com/pub/cd/tinymodules/napdos/software/esearch/>

2. Launch the **eSearch utility** and click the **Search Server** button

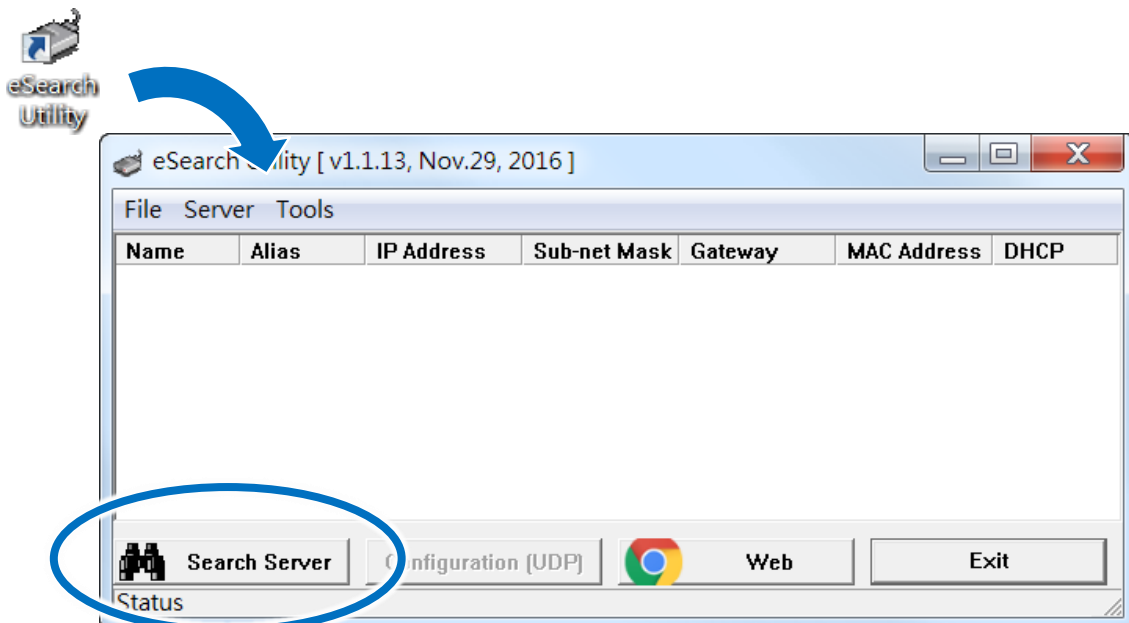

3. Once the search process has completed, double-click the name of iKAN display to open the **Configure Server (UDP)** dialog box

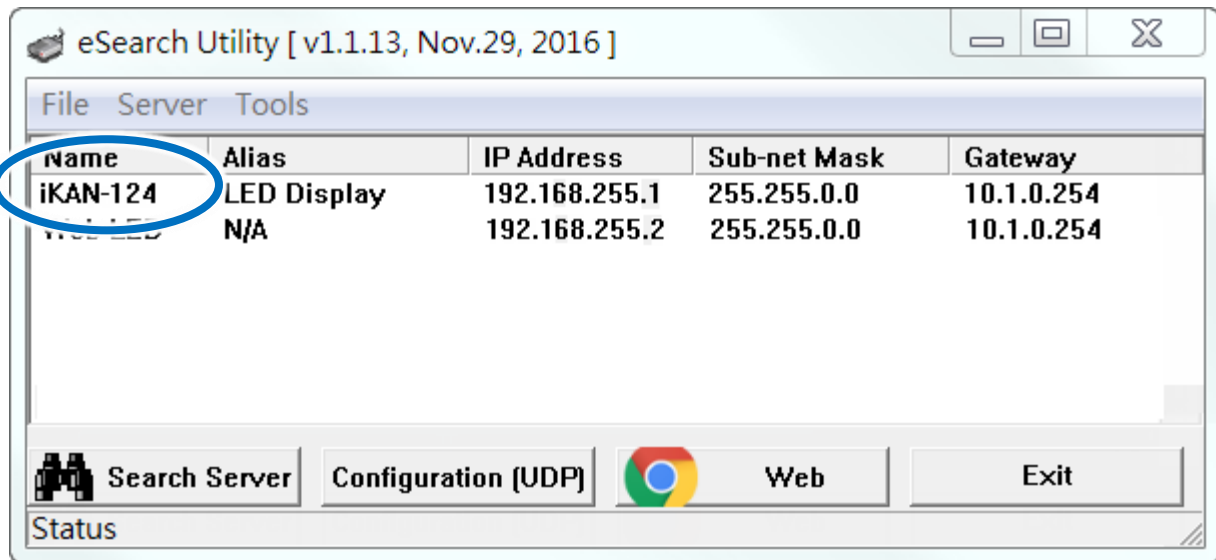

4. Enter the relevant values for the IP Address, Subnet Mask and Gateway, etc., and then click the **OK** button. The new settings for the iKAN display will take effect within 2 seconds.

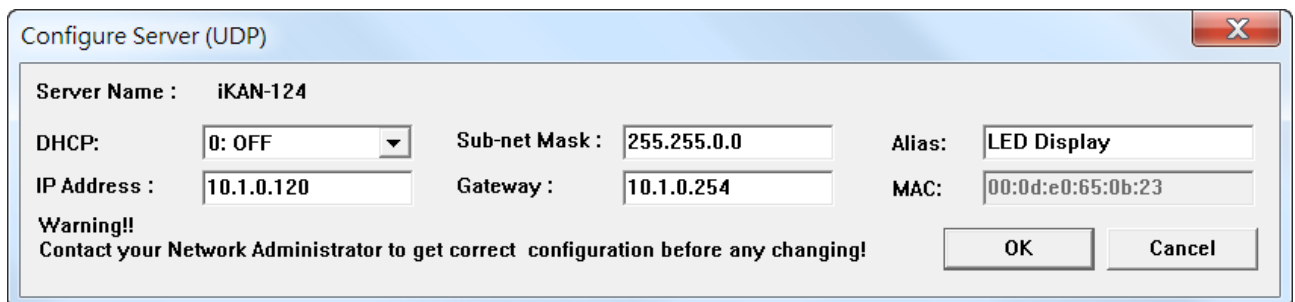



## 2.5. PROFIBUS configuration

PROFIBUS master has its own PROFIBUS configuration tool. Therefore, PROFIBUS configuration has a little difference in different PROFIBUS configuration tool. Here we use Siemens PLC (CPU315-2PN/DP) and SIMATIC STEP 7 in this example.

### 1. GSD file:

a. IKAN-PFB's GSD file can get from the following link.

**Add the link of IKAN-PFB's GSD file here.**

b. Create a new project in SIMATIC STEP 7 and click "Hardware".

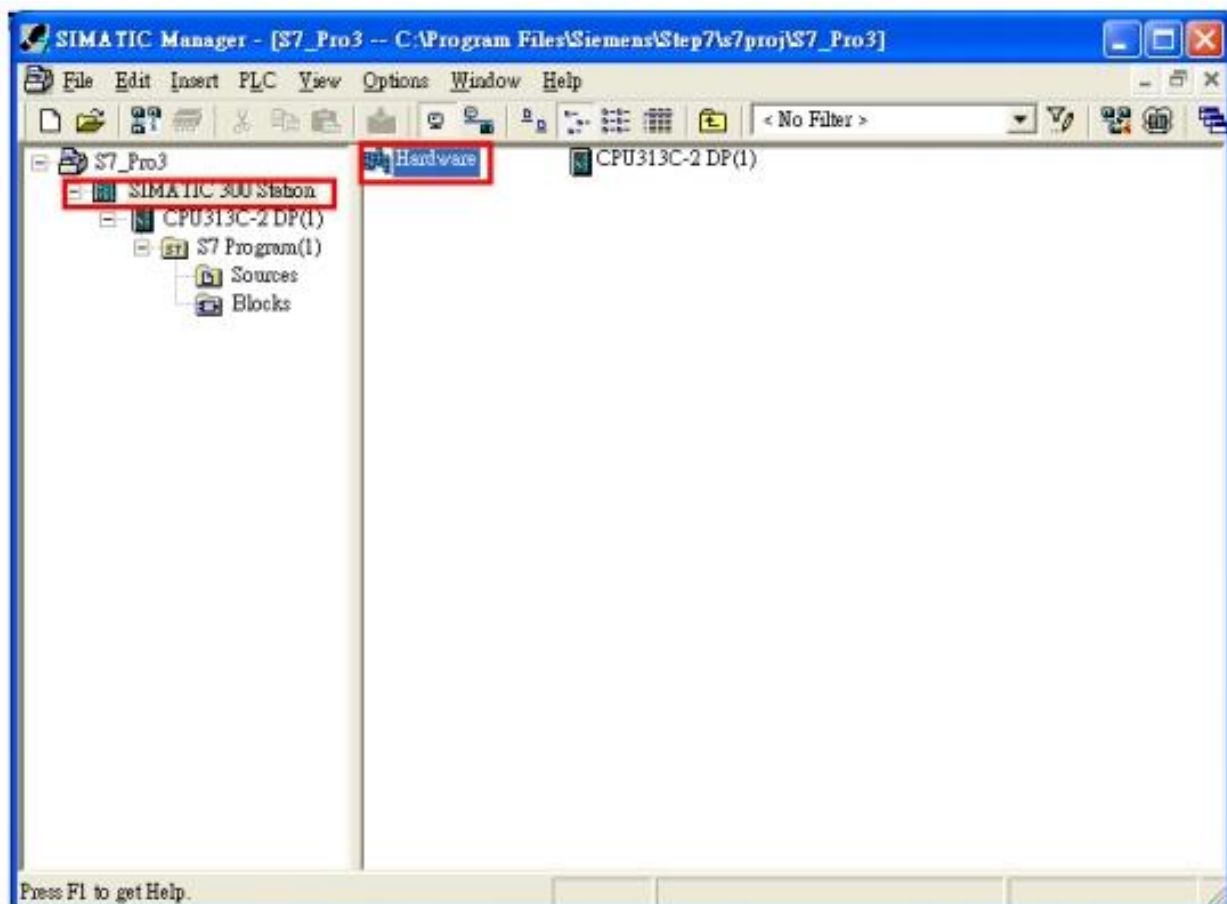

c. Click “Option” and then click “Install GSD File”.

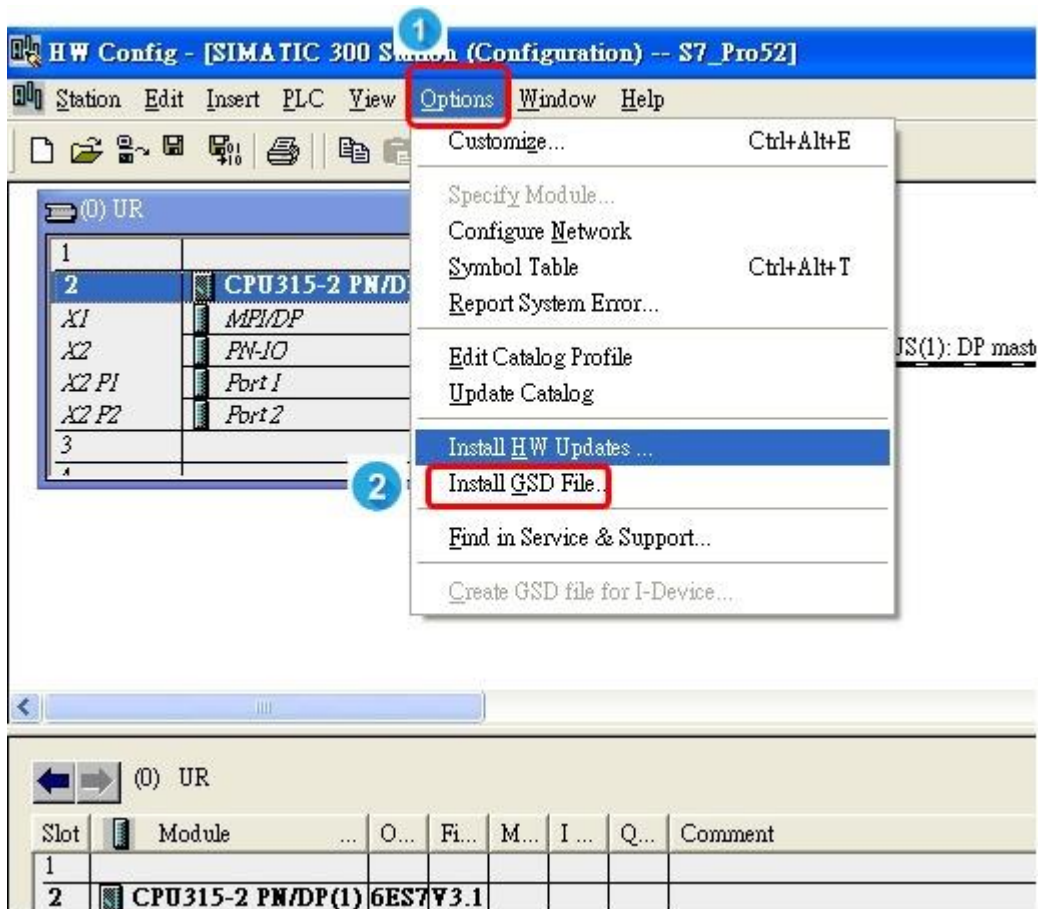

d. Select the directory of IKAN-PFB’s GSD file(IKAN0c0d.gsd) and click “OK”.

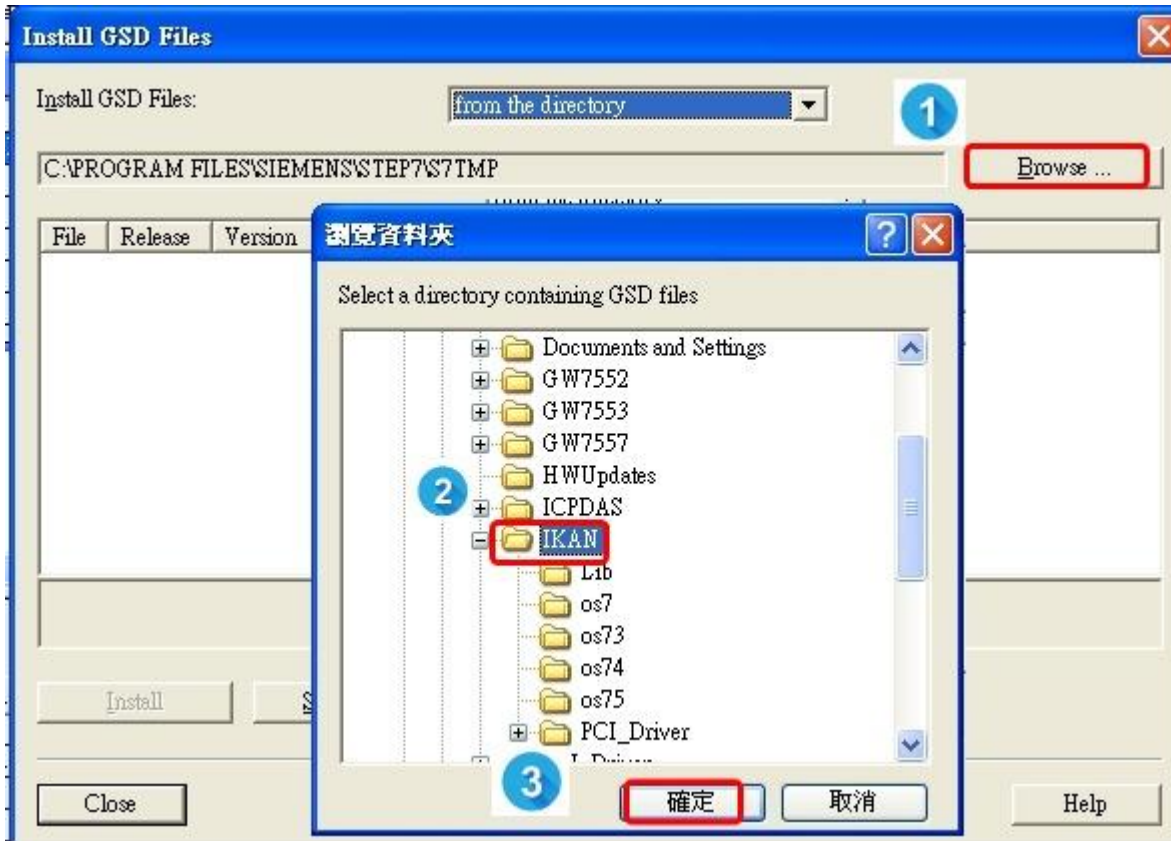

e. Select IKAN0c0d.gsd and click "Install".



f. Confirm IKAN-PFB is successfully installed.

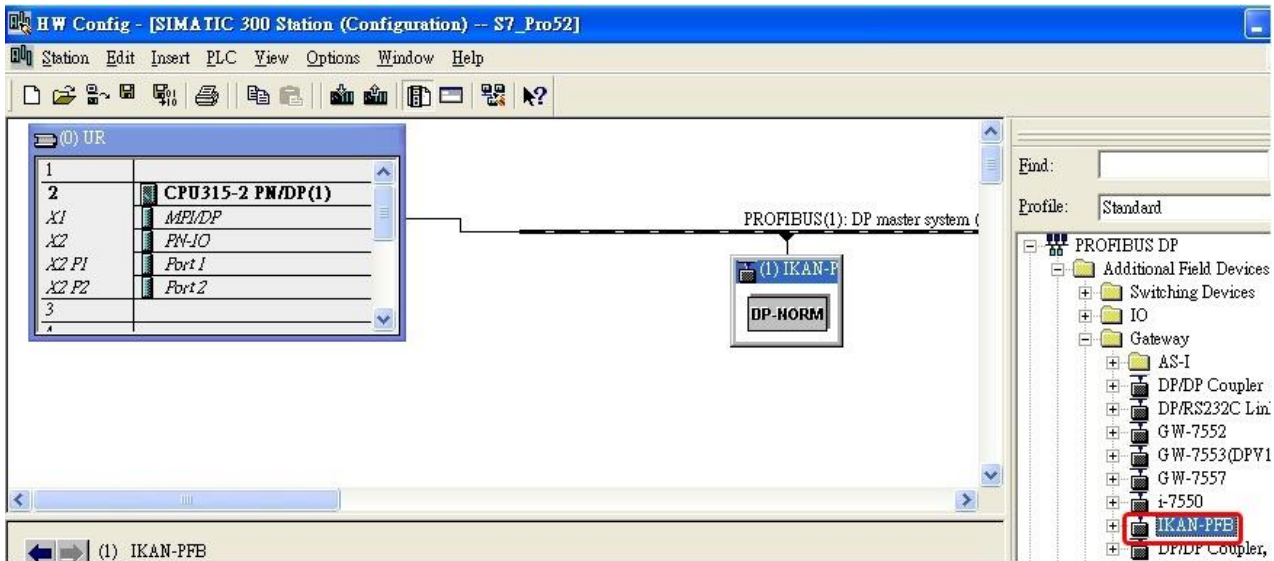

## 2. Set IKAN-PFB's address

a. Click IKAN-PFB icon and drag it to PROFIBUS DP master system.

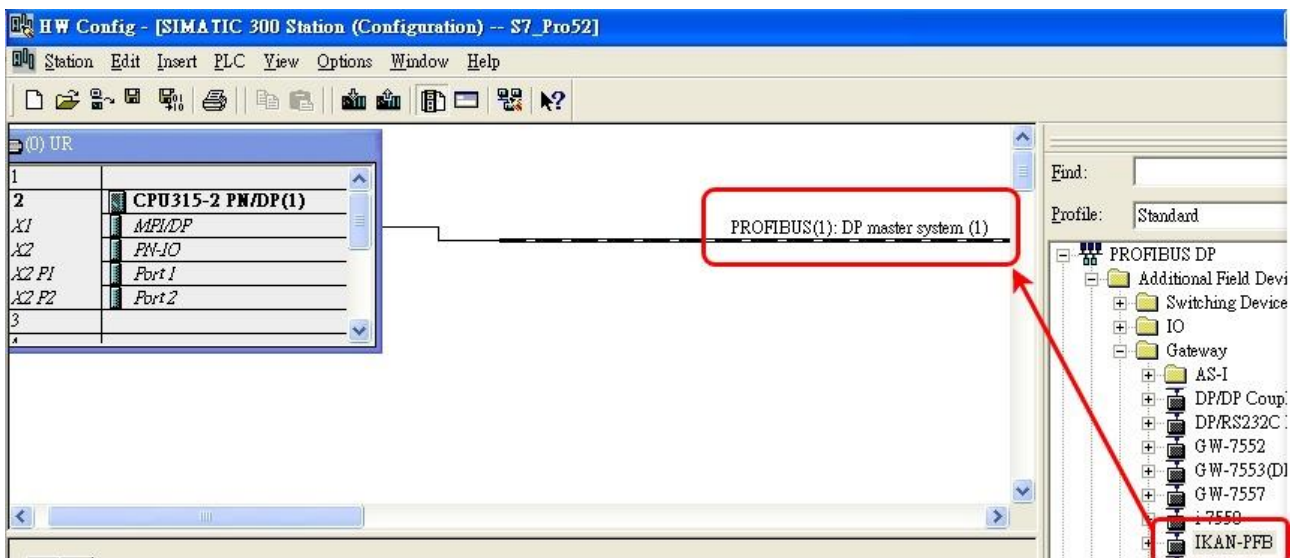

b. Set IKAN-PFB's address and click "OK".

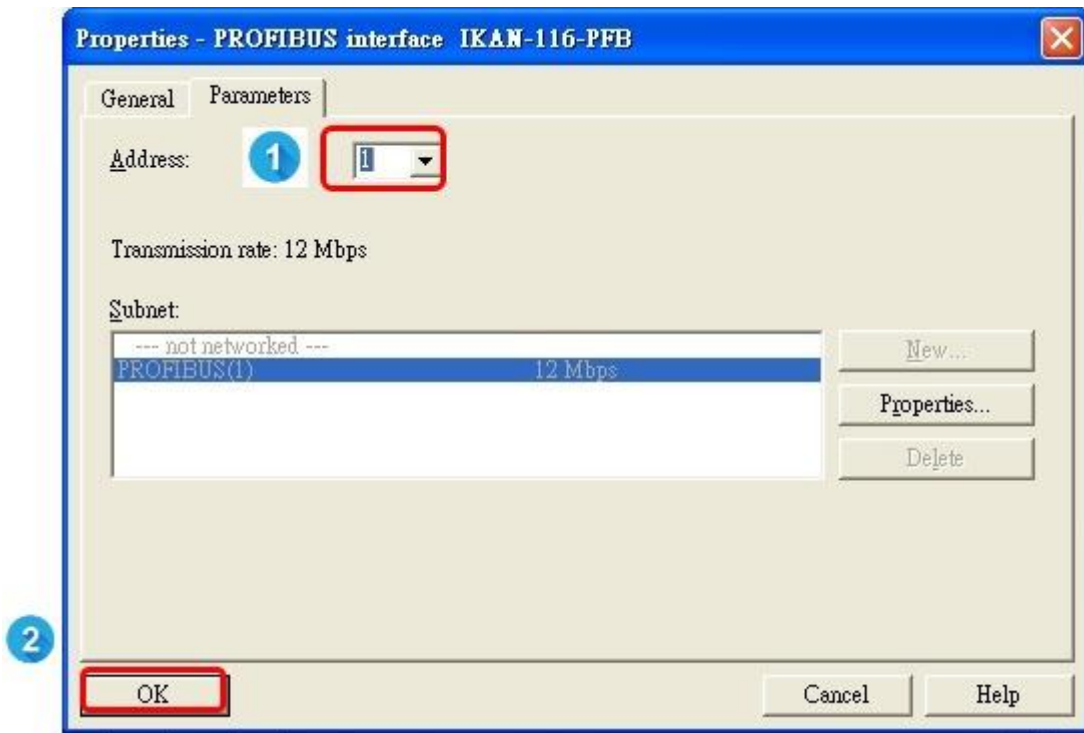

c. Open a web browser.

d. Type the IP address of the iKAN display in the address bar, and then press **Enter** to display the web interface

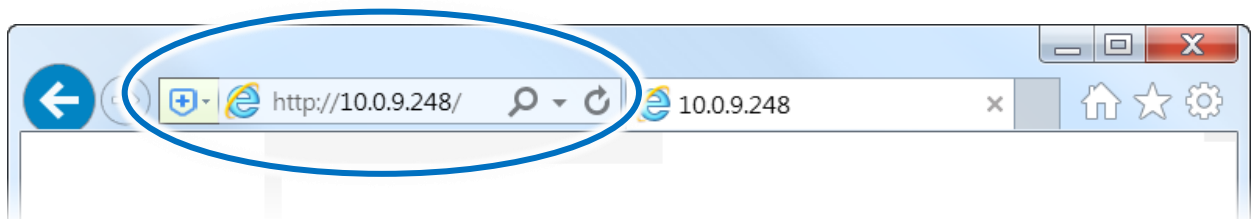

e. Click in the following of "System", "Serial Port", and "COM3". Set IKAN-PFB's PROFIBUS ID (PROFIBUS ID must be same with IKAN-PFB's address which you set in SIMATIC STEP 7).



Then click “Update Settings”.



### 3. Set the parameters of IKAN-PFB and the module of IKAN-PFB.

a. Double click “IKAN-PFB”, and click “Parameter Assignment” and “Device-specific parameter”. Set the parameters of IKAN-PFB here and then click “OK”.

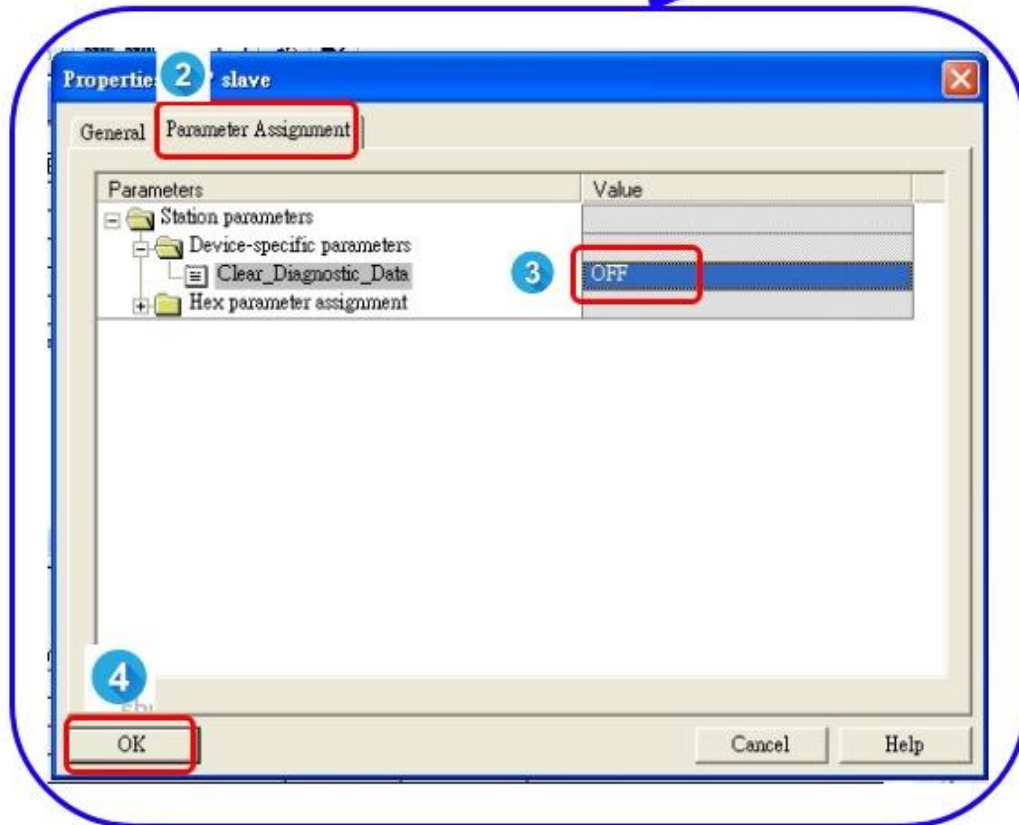
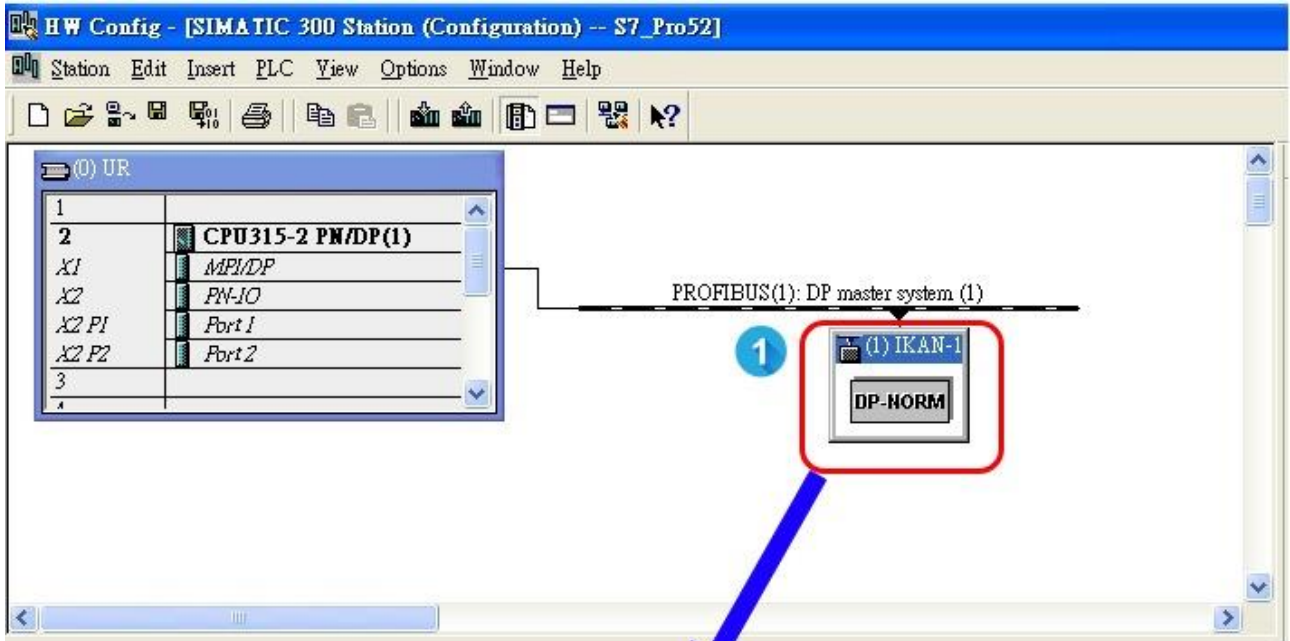

b. Click "IKAN-PFB" icon and then double click "System setting module". Confirm "System setting module" is added in IKAN-PFB.

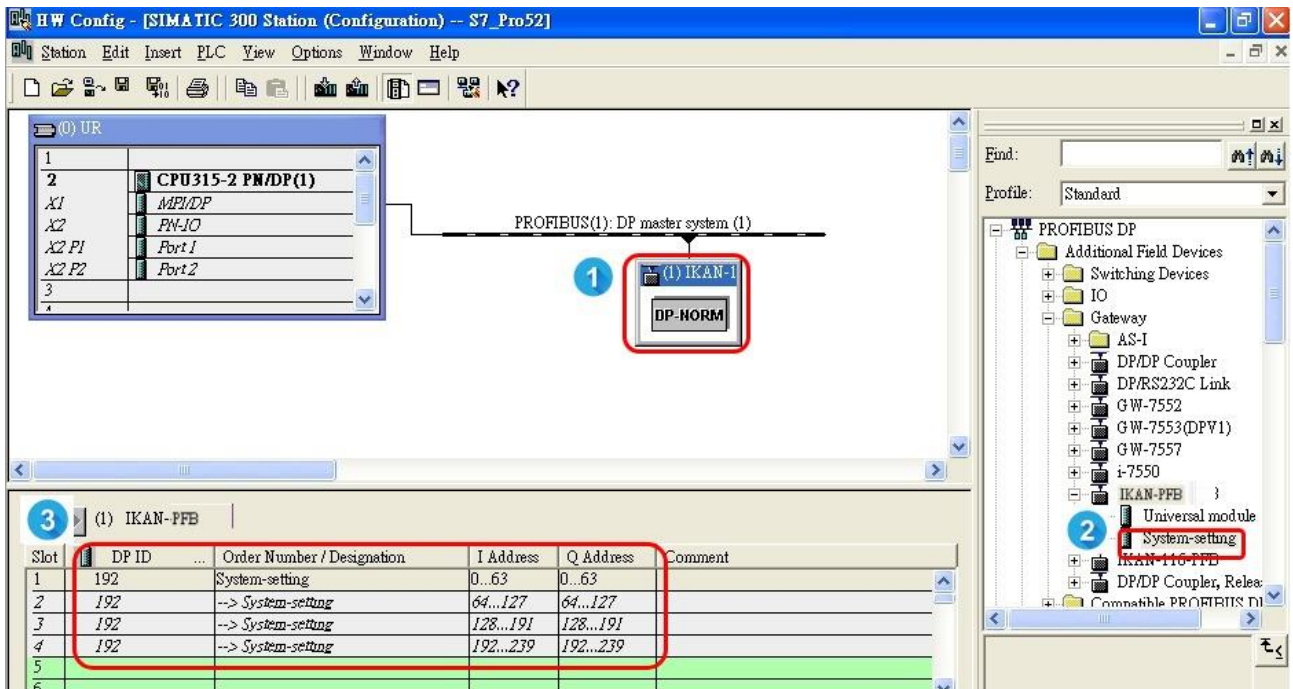

c. Compile and download the setting to PLC.

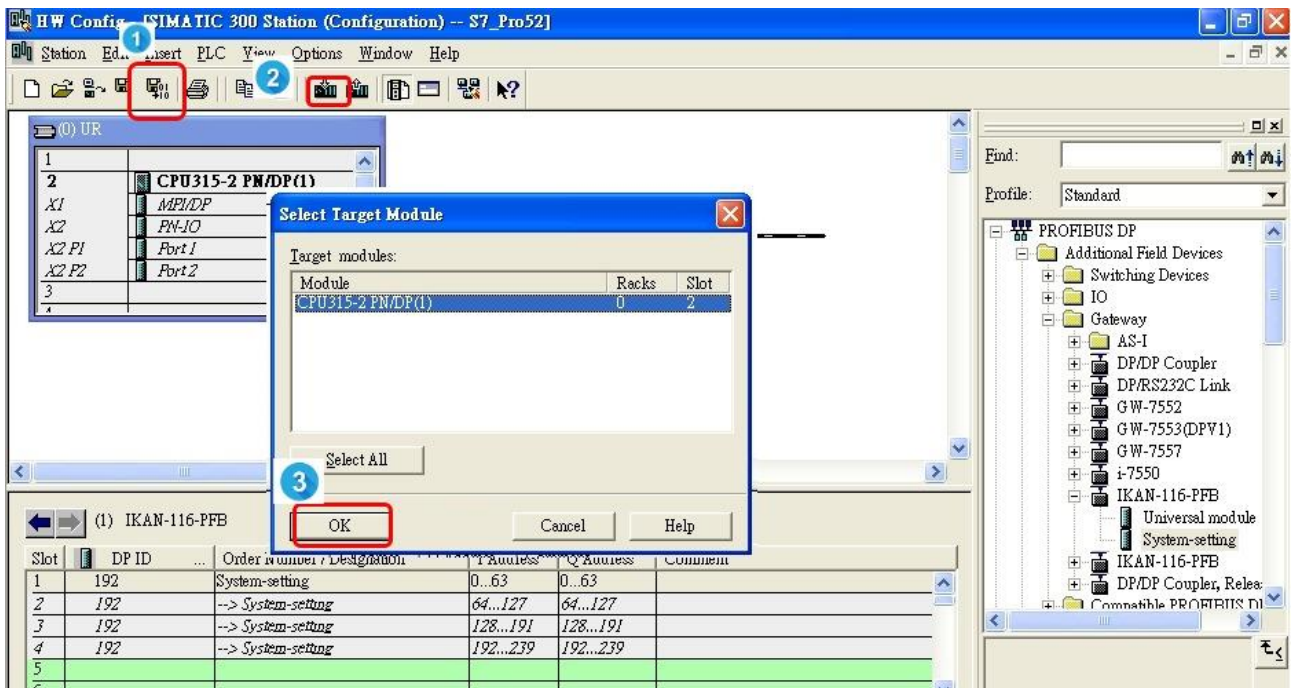

## 2.6. Editing Your First iKAN Message

The message can be configured using the built-in web interface. To edit your first message, follow the instructions given below.

1. Open a web browser
2. Type the IP address of the iKAN display in the address bar, and then press **Enter** to display the web interface

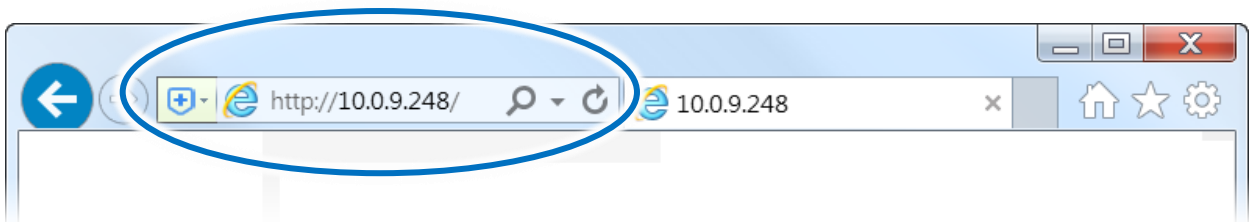

3. Click the **MESSAGE POOL** menu at the top of the page, select the message number you wish to add, and then click the **+** button
4. Click the  button

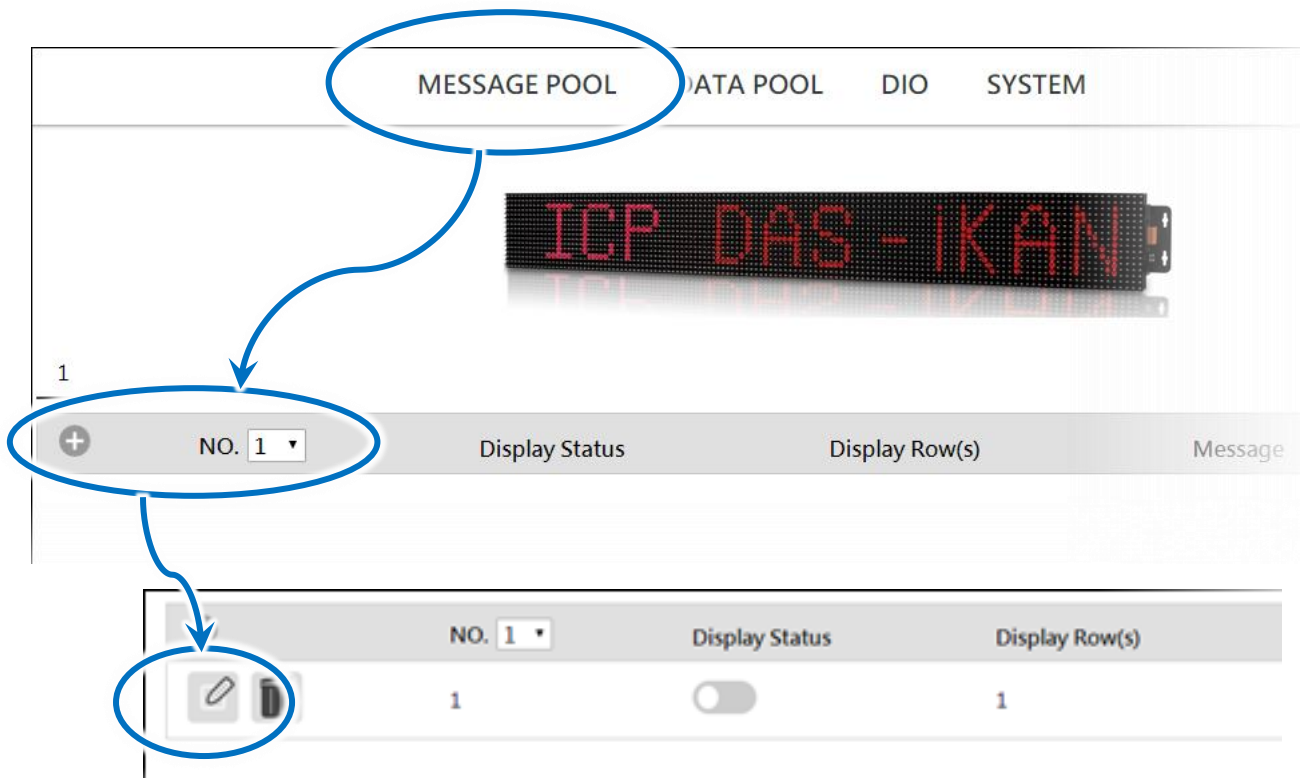

5. In the **No. 1** form, specify the following parameters:
- i. Enter the following string in the **Message** text field:  
Hello World!
  - ii. Click the **Update** button

NO. 1

Display Status  Instant

Message Moving Mode

Row(s)

Color

Message

6. Click in the following order “PROFIBUS”, “Message List0”, “Update”, and “Preview”. After you click “Preview”, you can see the output address of “Message List0” in IKAN-PFB

MESSAGE POOL DATA POOL **PROFIBUS** DIO SYSTEM EN 中

PROFIBUS Command Table Profibus Connection **Online**

Brightness & Speed

Brightness & Speed

Message List **2**

Message List0 Message List1 Message List2 Message List3 Message List4 Message List5 Message List6

3 Brightness & Speed Message List Coil Variables Integer Variables Float Variables DO DI **4** Preview **3** Update

**5**

PROFIBUS Command Table

NO	Profibus Output Address	Description
1	0	Message List_0

NO	Profibus Input Address	Description
----	------------------------	-------------

7. Calculate PROFIBUS output address of "Message List0" in PROFIBUS master.
- a. The output address of "Message List0" in IKAN-PFB (The value is 0 in this example).

**PROFIBUS Command Table**

NO	Profibus Output Address	Description
1	0	Message List_0

NO	Profibus Input Address	Description
----	------------------------	-------------

- b. The first output address of IKAN-PFB in PROFIBUS master (The value is 20 in this example).

← → (1) IKAN-116-PFB

Slot	DP ID	...	Order Number / Designation	I Address	Q Address
1	192		System-setting	36...99	20...83
2	192		--> System-setting	100...163	84...147
3	192		--> System-setting	164...227	148...211
4	192		--> System-setting	256...303	256...303
5					

- c. The output address of "Message List0" in PROFIBUS master= 0+20=20.

← → (1) IKAN-116-PFB

Slot	DP ID	...	Order Number / Designation	I Address	Q Address
1	192		System-setting	36...99	20...83
2	192		--> System-setting	100...163	84...147
3	192		--> System-setting	164...227	148...211
4	192		--> System-setting	256...303	256...303
5					

Address	Symbol	Display format	Status value	Modify value
QB 20		HEX	B#16#24	B#16#24
QB 21		HEX	B#16#00	B#16#00
QB 22		HEX	B#16#00	
QB 23		HEX	B#16#00	

**PROFIBUS Command Table**

NO	Profibus Address	Description
1	0	亮度及速度

- 1 | The first output address of IKAN-PFB in PROFIBUS master (20)

---

- 2 | The output address of "Message List0" in IKAN-PFB (0)

---

- 3 | The output address of "Message List0" in PROFIBUS master 0+20=20



8. Create the variable table in SIMATIC STEP 7, Change the value of PROFIBUS output address of "Message List0" to 0x80

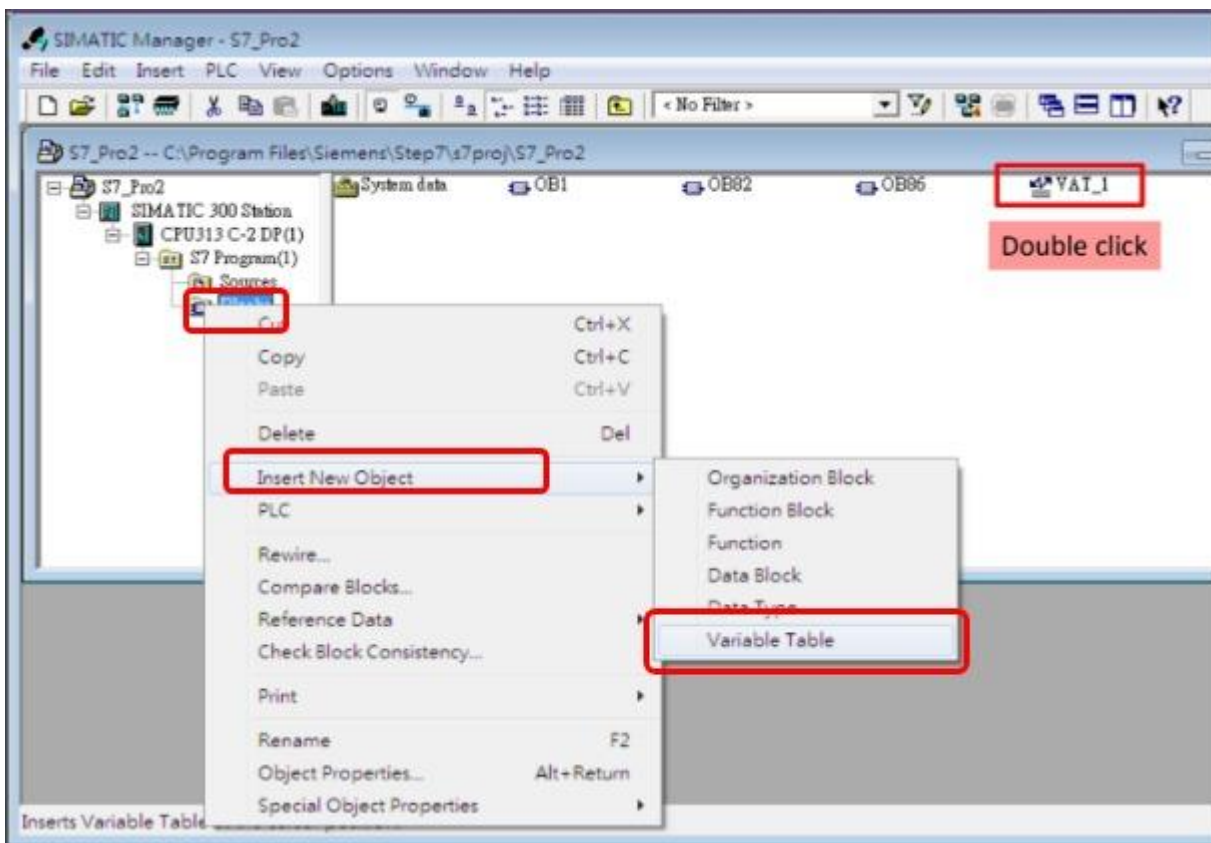



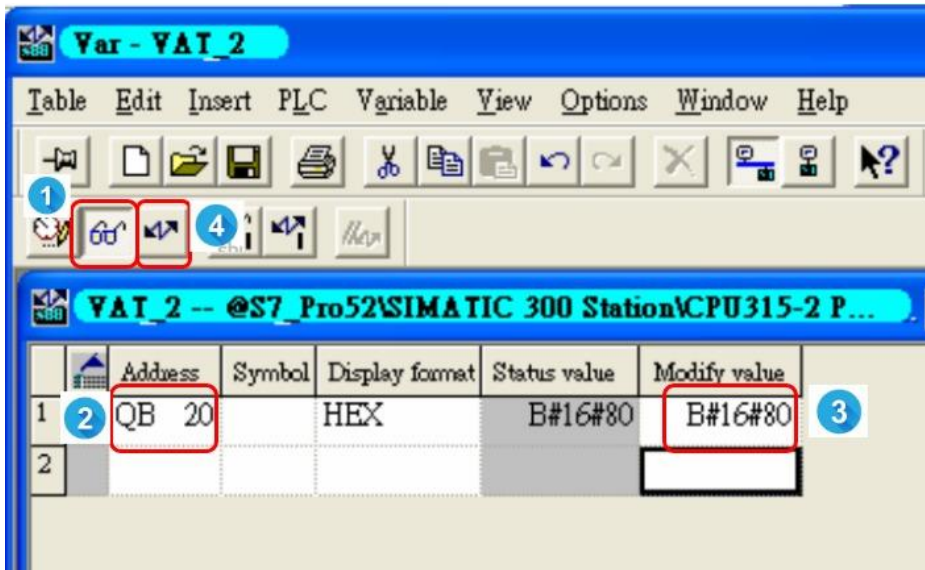

9. The messages will be shown on the display.

**Hello World!**

## **3. Configuration**

The iKAN series device can be accessed and configured using a standard web-browser (such as Internet Explorer, Firefox, Mac Safari etc) or Internet enabled mobile device.

### 3.1. Web Interface

The iKAN display has a built-in web interface. It provides lots of functions needed to manage all message displayed in iKAN as well as to set up parameters, variables and operation behavior. Most of the common operations can be done by using the iKAN Web Interface.

The following table lists the major function of the web interface and provides a link to more information about the function.

Menu	Sub-Menu	This menu is used to	Refer to section
MESSAGE POOL	-	Edit and message messages.	3.1.1 <b>Error!</b> <b>Reference source not found.</b> <b>Error!</b> <b>Reference source not found.</b>
DATA POOL	INTEGER	Specify a value to a variable and define the data type mappings	3.1.2 <b>Error!</b> <b>Reference source not found.</b> <b>Error!</b> <b>Reference source not found.</b>
	FLOAT		
	COIL		
SYSTEM	IMPORT/EXPORT	Import/Export pre-configured messages	3.1.3
	ETHERNET	Set the network address.	3.1.4
		Set the network address of the DL-302.	3.1.5

	SERIAL PORT	Set the communication parameters of the serial port	3.1.6
	MISC.	Assign a Modbus address to the iKAN display.	3.1.7
		Adjust the LED Brightness.	3.1.8
		Adjust the message moving speed.	3.1.9
		Reset the iKAN display to factory default settings.	3.1.10
		Adjust the LED Brightness.	3.1.11
		Reset the iKAN display.	3.1.12
		Check the firmware information.	3.1.13

### 3.1.1. Editing and Managing Messages

A maximum of 128 Common Messages and 20 Instant Messages can be stored on the iKAN series device, and each message can contain a maximum of 40 Unicode characters or 100 ASCII characters. The contents of each common message and instant message can be pre-configured individually via the **MESSAGE POOL** page on the web interface.

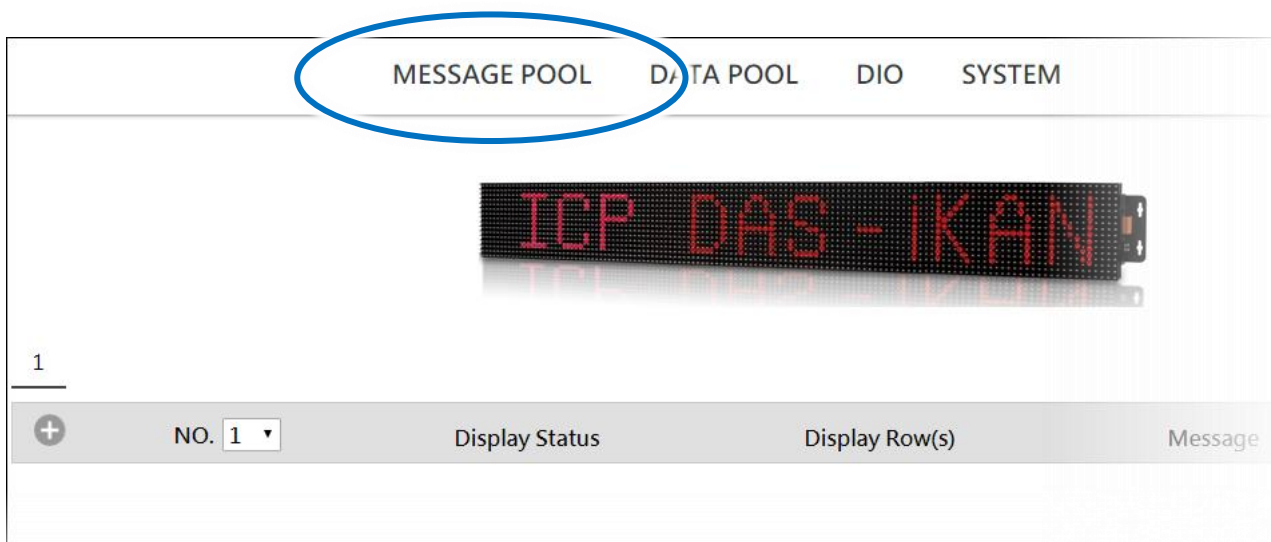

For more detailed information on how to edit and managing the message displayed, please refer

to Chapter “4. Message”

### 3.1.2. Applying the Variable Maps

The variable maps provide a mechanism for mapping data to a variable regardless of the data source. The variable maps are listed at the DATA POOL page. The value of most variables can be pre-specified individually via the variable maps.

To specify a value to a variable, follow the instructions given below.

1. Click the **DATA POOL** menu, and then click the menu of the variable type which you want to edit
2. Click the address number of the variable which you would like to configure.

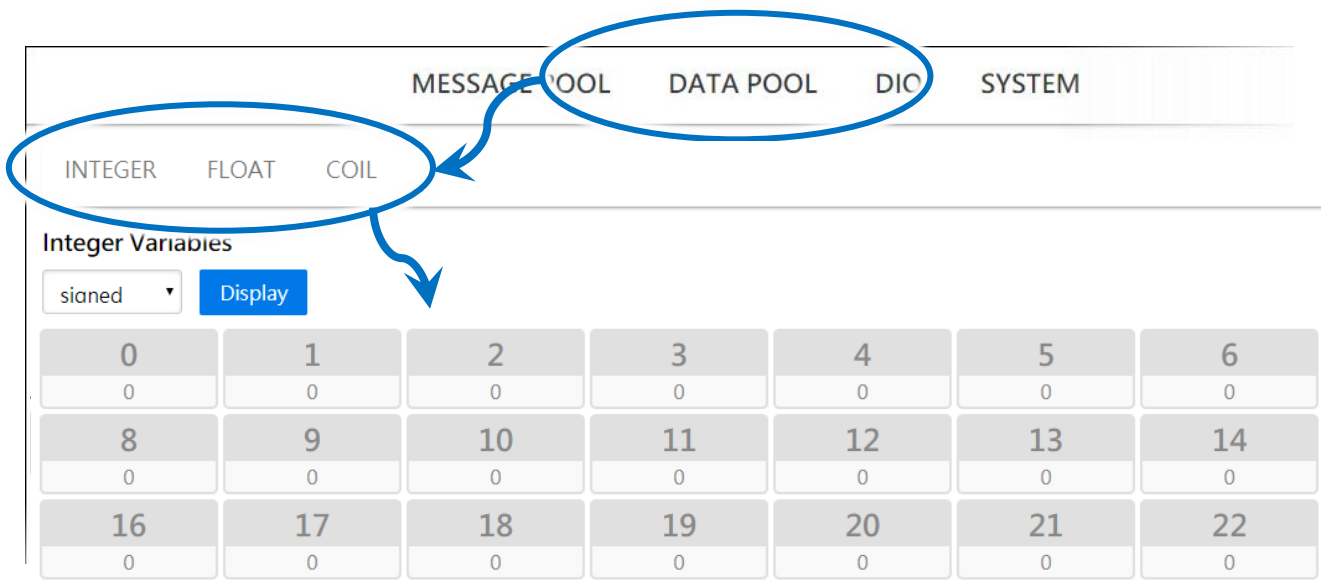

The screenshot shows a web interface for configuring variables. At the top, there are navigation tabs: MESSAGE POOL, DATA POOL, DIO, and SYSTEM. The 'DATA POOL' tab is selected and circled in blue. Below the tabs, there are three variable type options: INTEGER, FLOAT, and COIL. The 'INTEGER' option is circled in blue, and a blue arrow points from it to the 'Integer Variables' section below. In the 'Integer Variables' section, there is a dropdown menu set to 'signed' and a blue 'Display' button. Below this, there is a grid of 23 variable address boxes, each containing a value of 0. The addresses are arranged in three rows: the first row has addresses 0-6, the second row has 8-14, and the third row has 16-22. A blue arrow points from the 'INTEGER' tab to the 'Integer Variables' section, and another blue arrow points from the 'Integer Variables' section to the first variable address box (0).

0	1	2	3	4	5	6
0	0	0	0	0	0	0
8	9	10	11	12	13	14
0	0	0	0	0	0	0
16	17	18	19	20	21	22
0	0	0	0	0	0	0

The configuration area has been registered according to the selected address number. The configuration area provides the following functions:



The image shows a configuration interface enclosed in a dashed border. On the left, there is a red '1' followed by a text box containing '0'. To the right of the text box is a dropdown menu with 'Red' selected. Further right are three buttons: 'Update', 'Adv. Config', and 'Cancel'.

- **Assign a value to a variable**

In the text box, enter the relevant values for the selected variable, and then enter the **Update** button

- **Specify the color of a variable displayed in the variable map**

From the drop-down menu, select the desired color for the variable, and then enter the **Update** button

For more details, please refer to section “4.3. Displaying the Value Applied with the Variable Map”

### **3.1.2.1. Mapping Physical Values to Integer-Type Variables**

Most industrial measuring devices use 16-bit integers to convert a value from a data source to a real physical value, such as the voltage, temperature, or relative humidity, etc. For example, using the range -32768 to 32767 to convert to -10V to +10V. The iKAN series device is able to perform data mapping to translate an integer value that has been read from a remote data source to a readable physical value.

For more detailed information on how to increase the decimal places for the number of float-type variable, please refer to section “4.3.1. Displaying the Mapping Data for Integer-type Variables”



### **3.1.2.2. Increasing the Decimal Places for the Number of Float-Type Variable**

The number of the decimal places to be used for a float-type variable can be set from the FLOAT VARIABLES page. The offset value is 40128, which means variable 0 is equal to 40128 and variable 2 is equal to 40130, and so on.

For more detailed information on how to increase the decimal places for the number of float-type variable, please refer to section “4.3.2. Displaying the Number with Increased Decimal Places for Float-Type Variables”

### **3.1.2.3. Assigning Strings to Coil Variables**

iKAN series devices provide a string mapping function that allows the value of the coil variable to be mapped in order to make the coil value more meaningful when reading the message. The text mapping function allows a maximum of 10 Unicode characters or 30 ASCII characters to be entered to represent a value of 0 or 1.

For more detailed information on how to increase the decimal places for the number of float-type variable, please refer to section “4.3.3. Displaying the Value of a Coil Variable with the Replacement Text”

### 3.1.3. Importing/Exporting pre-configured messages

If your system contains more than one iKAN series device, it could take a lot of time to configure each one individually. To simplify this process, the Import/Export function that can be used to pre-configure the contents of a message or variable on the iKAN series device before using Modbus TCP/RTU commands to manage the message pool, thereby reducing the need to repeat the configuration tasks multiple times.

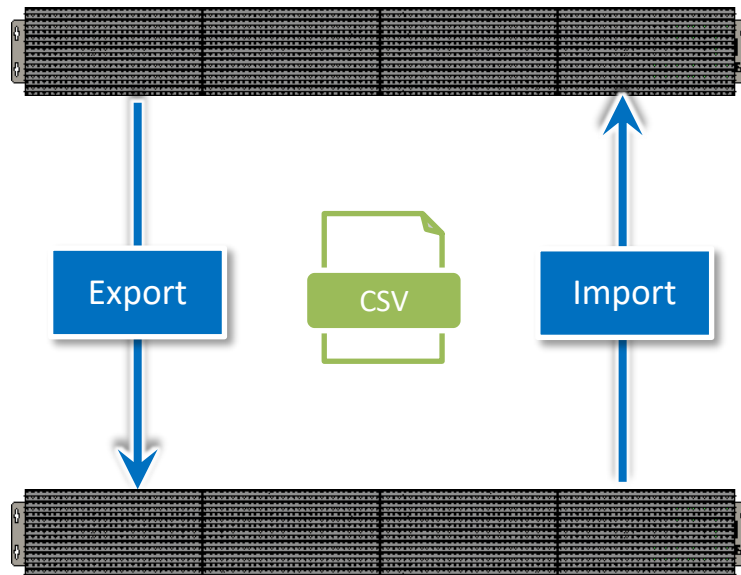

### 3.1.3.1. Importing a configuration file

The contents of a message and variable can be imported to a CSV file. The following is a description of how to import a previously stored configuration file. Note that the Import function will only load configuration information related to messages and variables.

1. Click the **SYSTEM** menu, and then click the **IMPORT/EXPORT** menu
2. Click the **Choose File** button to select the desired CSV file, and then click the **Import** button to load the contents of the configuration file

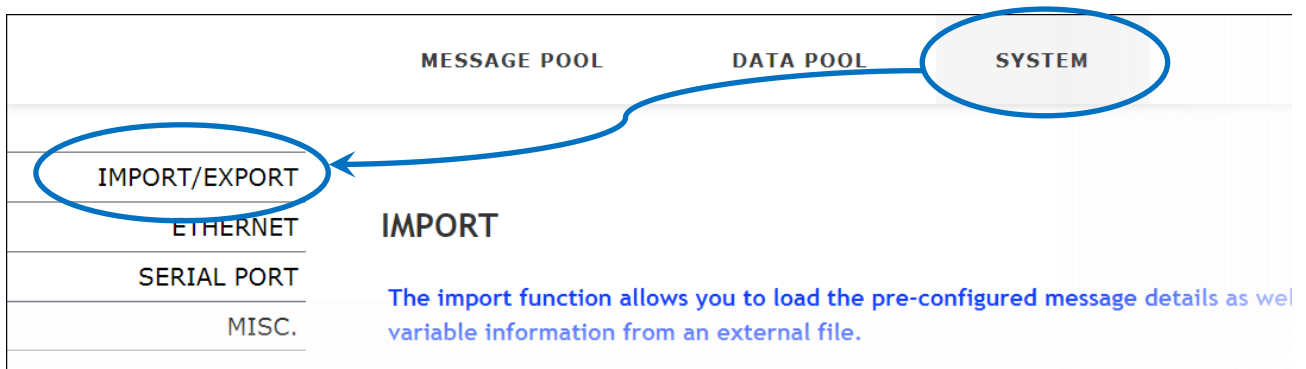

### 3.1.3.2. Exporting a configuration file

The contents of a message and variable can be exported as a CSV file. The default file name is msg\_con.csv, which can be changed to a preferred file name.

1. Click the **SYSTEM** menu, and then click the **IMPORT/EXPORT** menu
2. Click the **Choose File** button to select the desired CSV file, and then click the **Import** button to load the contents of the configuration file

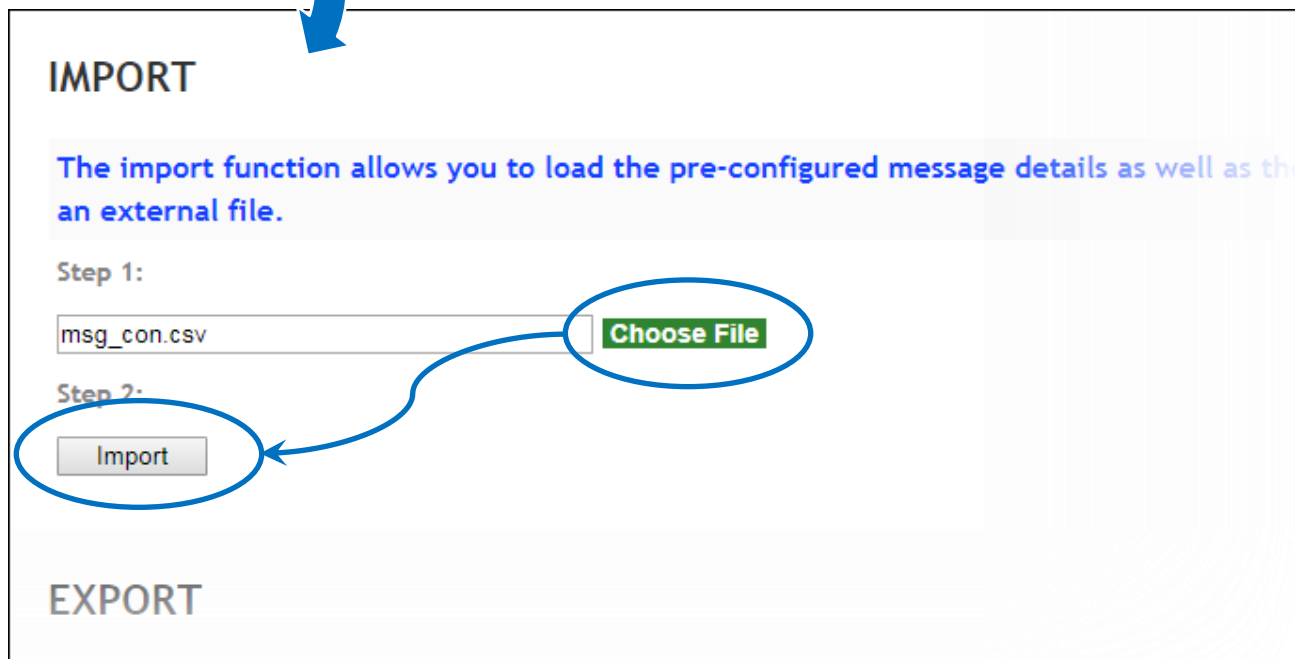
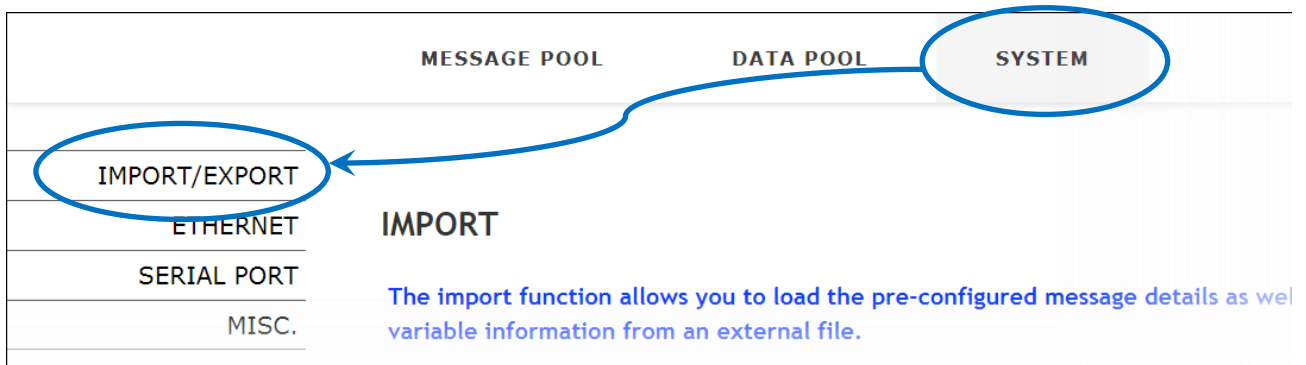

### 3.1.4. Changing the IP Address

The IP address can be changed. To change the IP address, follow the instructions given below.

1. Click the **SYSTEM** menu, and then click the **ETHERNET** menu
2. Enter the IP address for the iKAN



### 3.1.5. Connecting to a remote DL-302 device

The iKAN series devices can be used to display data such as the temperature, humidity and CO2 values sourced from a specific remote DL-302 device that is connected to the same network as the iKAN device.

Once the IP address for the DL-302 device has been configured, the data recorded by the DL-302 can be automatically obtained. To specify the IP address of the required DL-302 device, follow the instructions given below.

1. Click the **SYSTEM** menu, and then click the **ETHERNET** menu
2. Enter the IP address for the desired DL-302, and then click the **Update Settings** button

The screenshot shows the configuration interface of an iKAN device. At the top, there are three menu options: MESSAGE POOL, DATA POOL, and SYSTEM. The SYSTEM menu is circled in blue. Below these, there is a sidebar with options: IMPORT/EXPORT, ETHERNET (circled in blue), SERIAL PORT, and MISC. The main content area is titled LOCAL ETHERNET and contains three rows of input fields: IP Address (10.0.9.248), Mask (255.255.255.0), and Gateway (10.0.9.254). Below this, there is a section titled REMOTE DL-302, which is circled in blue. It contains an IP Address input field (10.1.0.153) and an Update Settings button. A blue arrow points from the ETHERNET menu option to the LOCAL ETHERNET section, and another blue arrow points from the LOCAL ETHERNET section to the REMOTE DL-302 section.

MESSAGE POOL	DATA POOL	SYSTEM
IMPORT/EXPORT		
<b>ETHERNET</b>		
SERIAL PORT		
MISC.		

**LOCAL ETHERNET**

IP Address: 10 . 0 . 9 . 248

Mask: 255 . 255 . 255 . 0

Gateway: 10 . 0 . 9 . 254

**REMOTE DL-302**

IP Address: 10 . 1 . 0 . 153

Update Settings

### 3.1.6. Setting the Serial Port

The serial port can be set up to establish a connection between the iKAN and the serial I/O devices. The default parameters are 11520 baud, 8 data bits, 1 stop bit, and NO Parity. To set the serial port, follow the instructions given below.

1. Click the **SYSTEM** menu, and then click the **SERIAL PORT** menu
- 2: Set the serial port parameters, and then click **Update Settings** button to complete the process

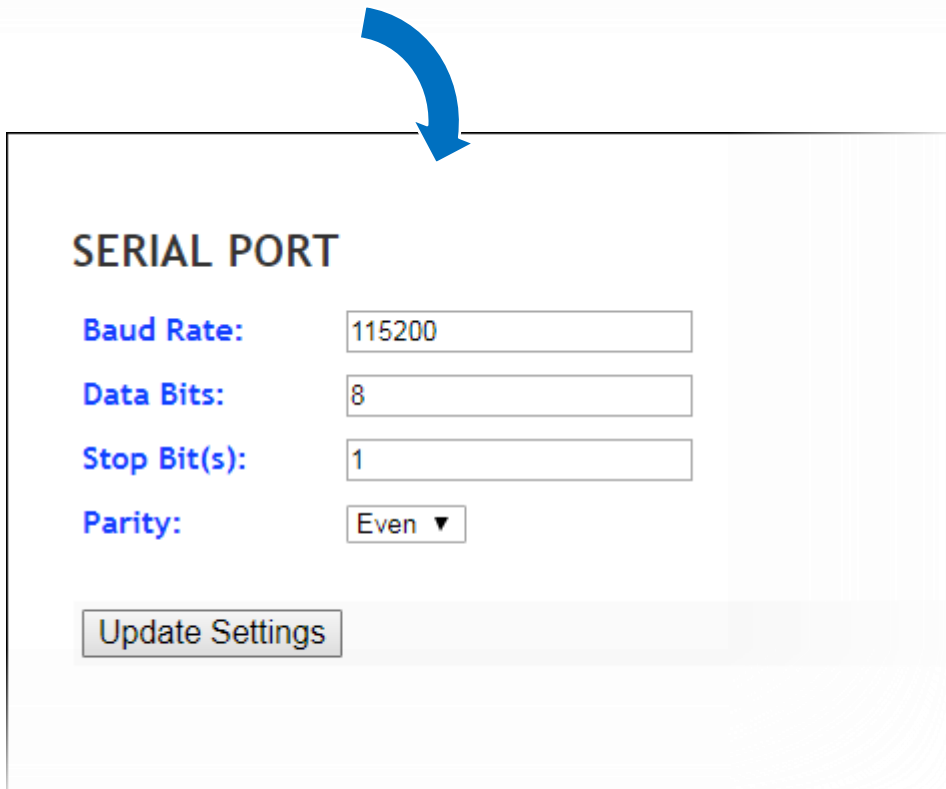



### 3.1.7. \*Setting the Modbus ID

MODBUS ID is the identification for the communication between the iKAN and other devices which use MODBUS protocol. To set the Modbus ID, follow the instructions given below.

1. Click the **SYSTEM** menu, and then click the **Misc.** menu
- 2: Set the Modbus ID, and then click **Update** button to complete the process

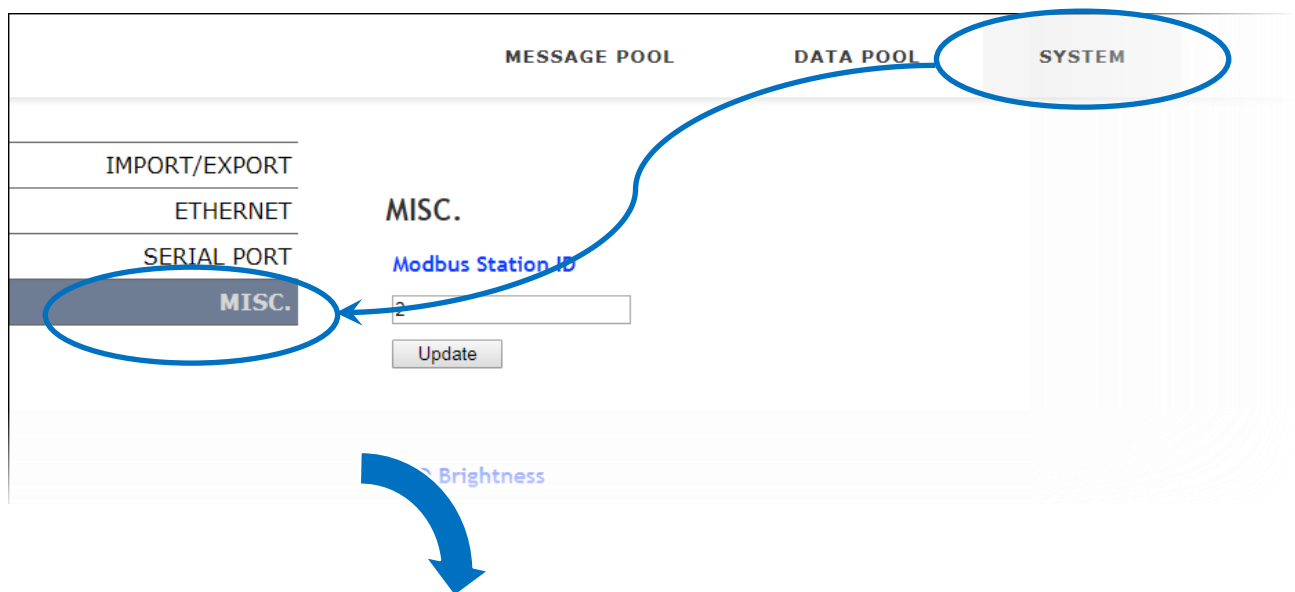

### 3.1.8. \*Adjusting the LED Brightness

5 levels of brightness are adjustable on the iKAN display. Smaller setting numbers are paired with brighter. To adjust the LED brightness, follow the instructions given below.

1. Click the **SYSTEM** menu, and then click the **Misc.** menu
- 2: In the **LED Brightness** section, select the setting number from the drop and down menu, and then click the **Update** button

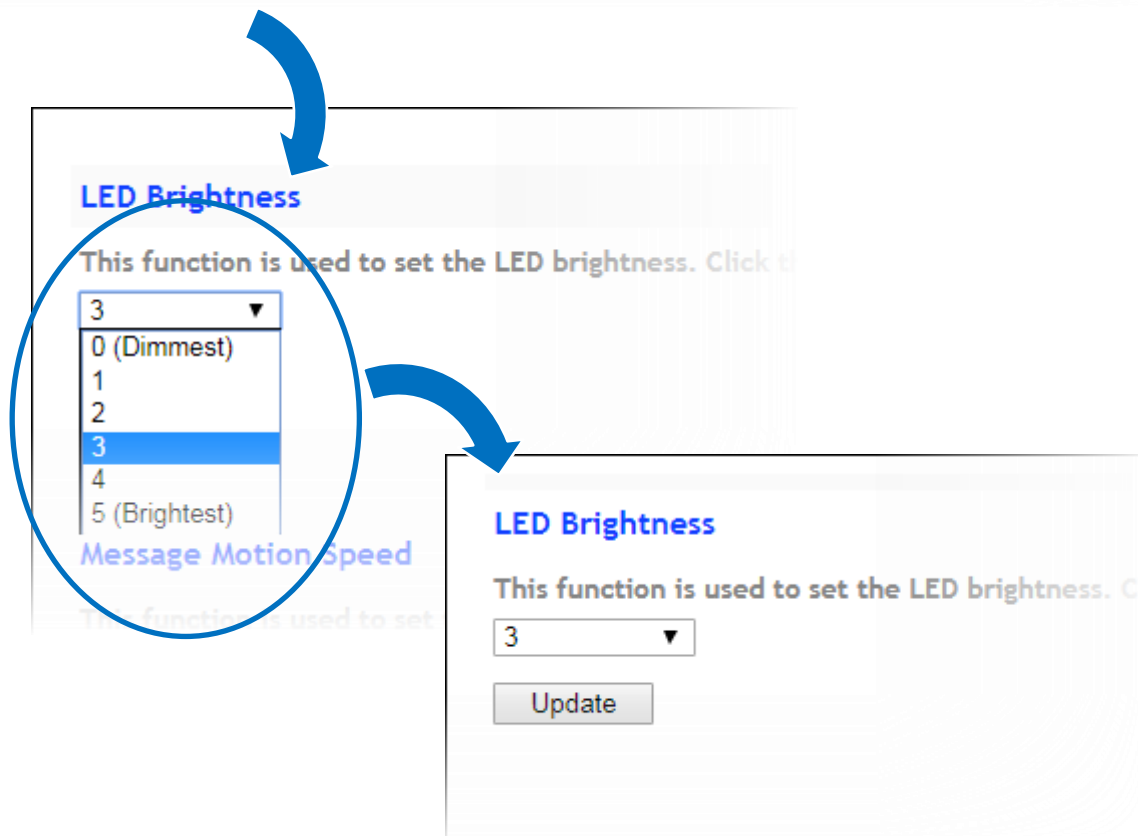
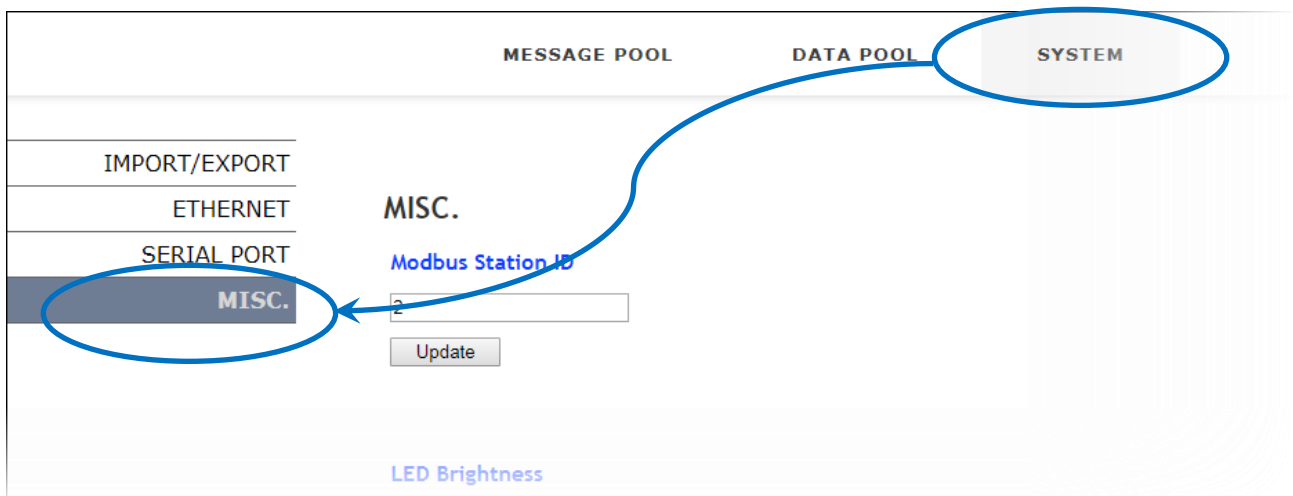

### 3.1.9. \*Adjusting the Message Motion Speed

10 levels of message motion speed are adjustable on the iKAN display. Smaller setting numbers are paired with higher scrolling speeds. To adjust the message motion speed, follow the instructions given below.

1. Click the **SYSTEM** menu, and then click the **Misc.** menu
- 2: In the **Message Motion Speed** section, select the setting number from the drop and down menu, and then click the **Update** button

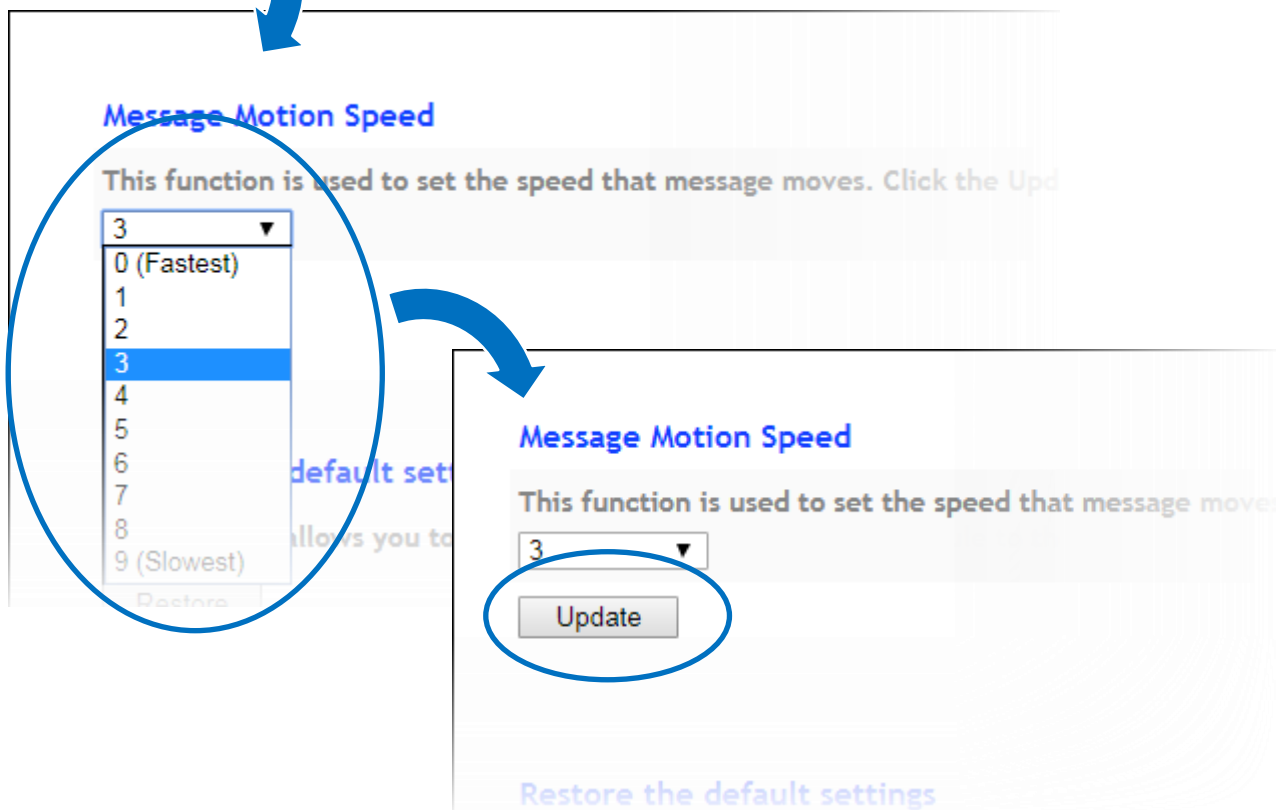
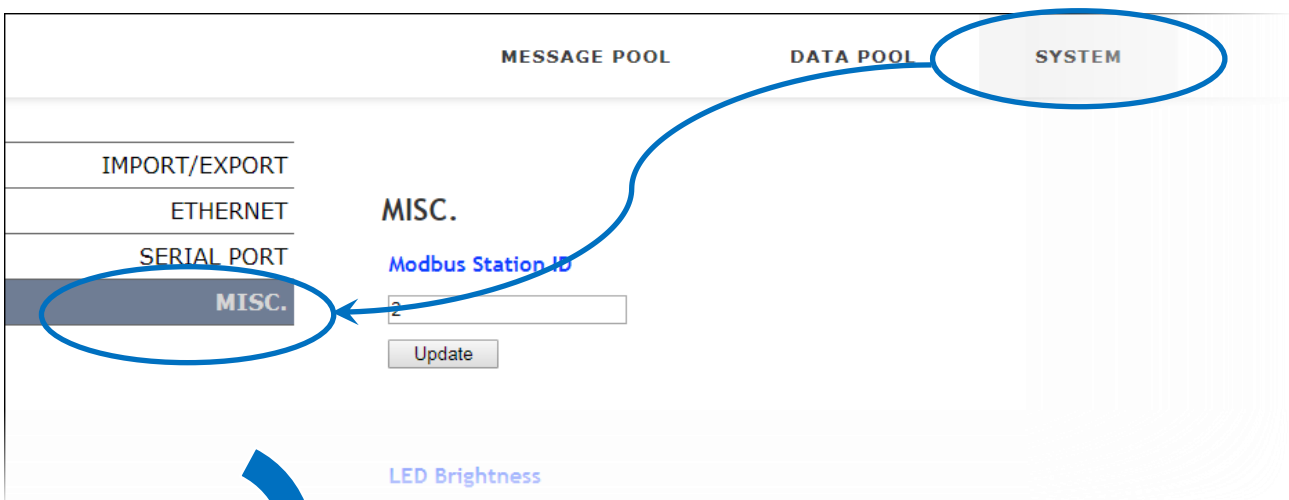

### 3.1.10. Restoring the Default Settings

This is function to provide a safe reset option for the iKAN display. All messages and variables configuration settings will be reset to factory default. To restore the default settings, follow the instructions given below.

1. Click the **SYSTEM** menu, and then click the **Misc.** menu
- 2: In the **Restore the default settings** section, click the **Restore** button

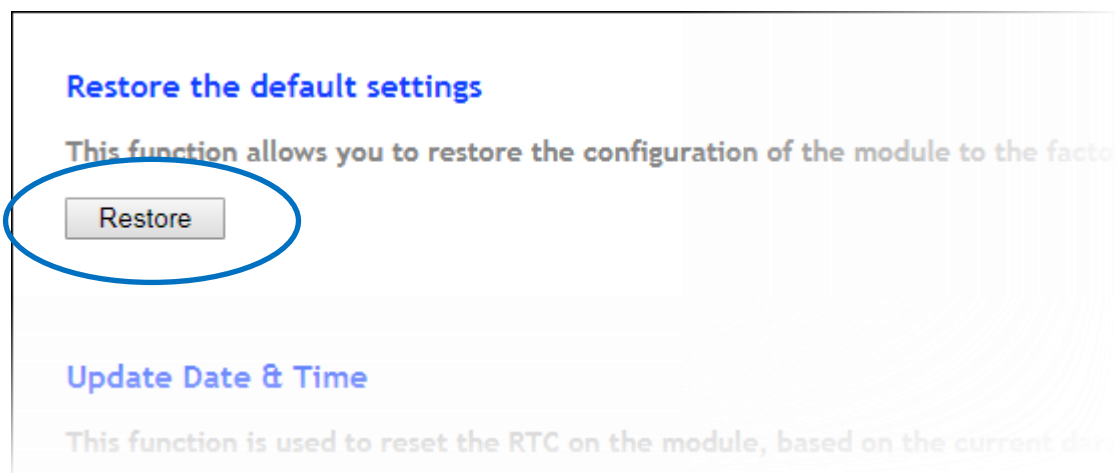
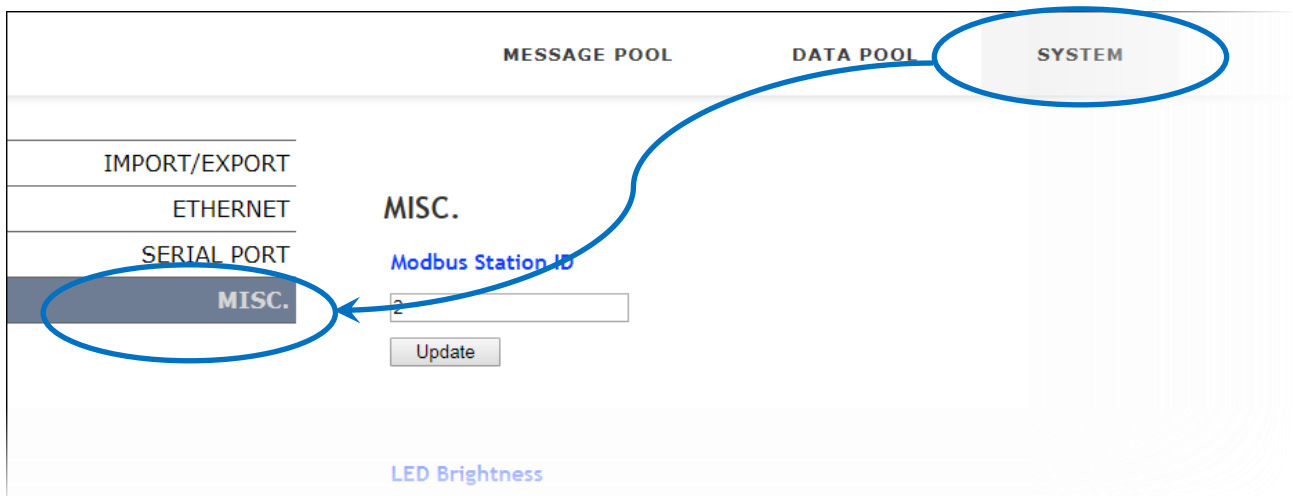

### 3.1.11. Updating Date and Time

This is function to synchronize date and time values on the iKAN display to PC. To synchronize the date and time value with PC, follow the instructions given below.

1. Click the **SYSTEM** menu, and then click the **Misc.** menu
- 2: Scroll down this page until you see the **Update Date & Time** section, and then click the **Update** button

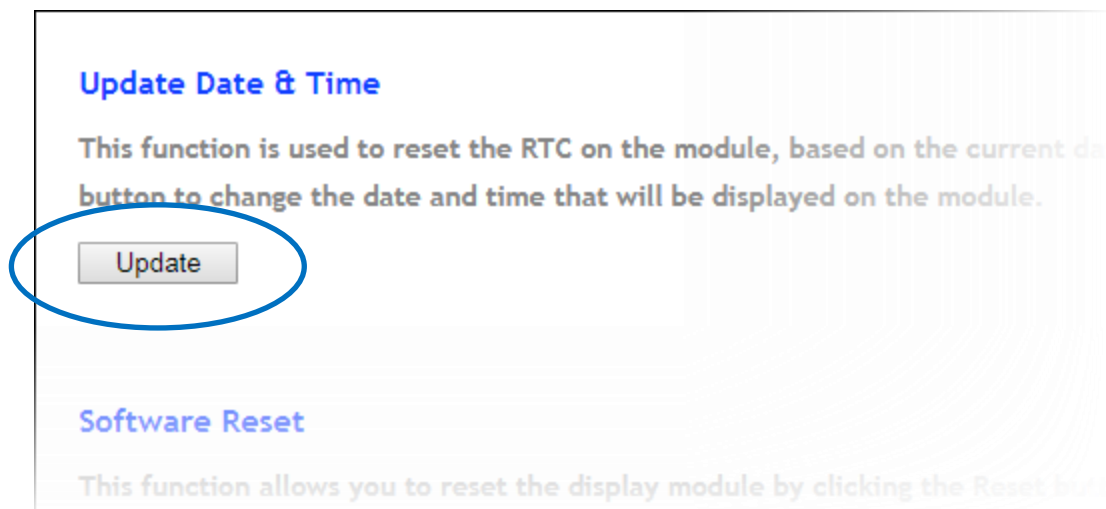
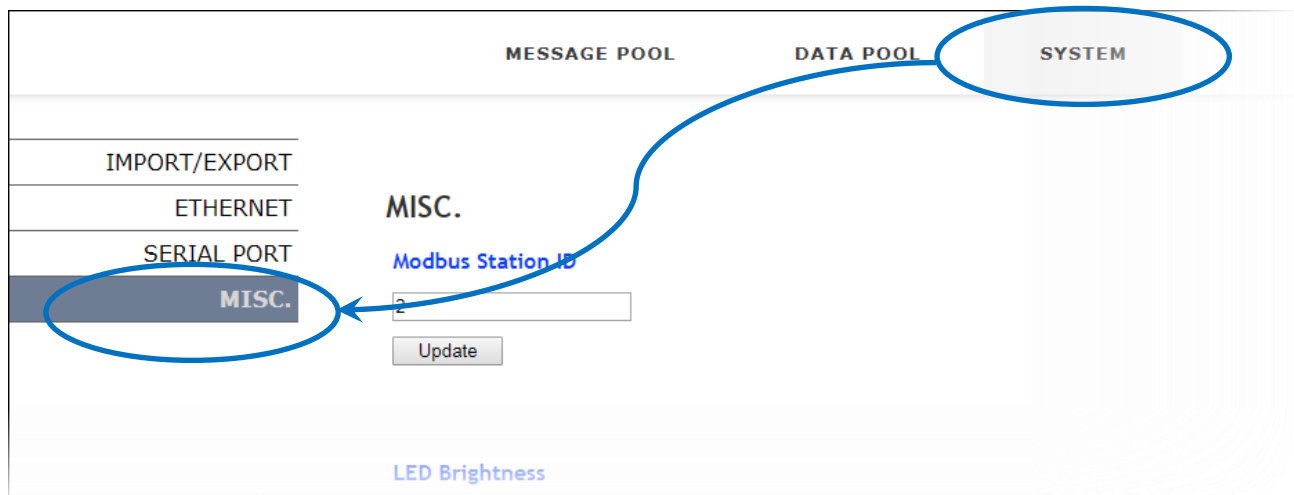



### 3.1.12. Resetting the Display

This function provides a safe reset option for the iKAN display. To reset the display, follow the instructions given below.

1. Click the **SYSTEM** menu, and then click the **Misc.** menu
- 2: Scroll down this page until you see the **Software Reset** section, and then click the **Reset** button

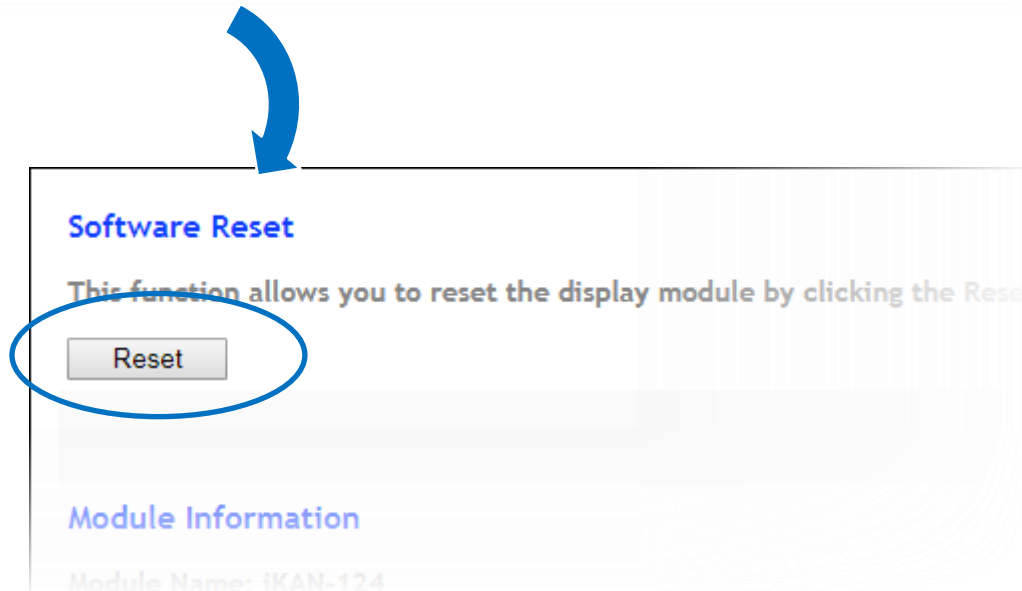
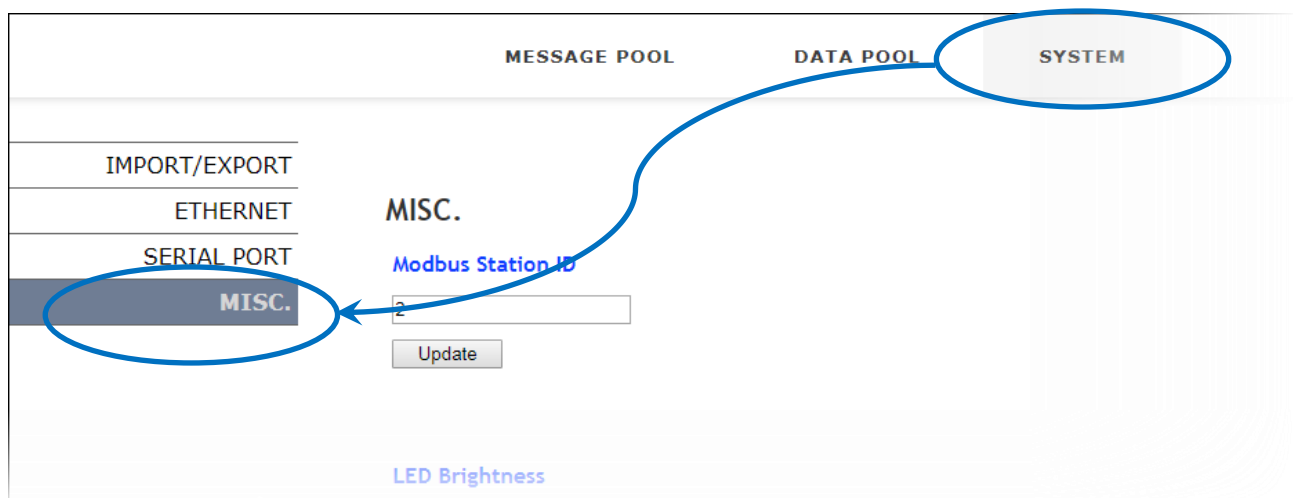

### 3.1.13. Checking the Firmware Information

This is function to check the firmware version and sub-device firmware version. To check the firmware version, follow the instructions given below.

1. Click the **SYSTEM** menu, and then click the **Misc.** menu
- 2: Scroll down this page until you see the **Module Information** section, you can check the version here to see if the iKAN series device needs a firmware update.

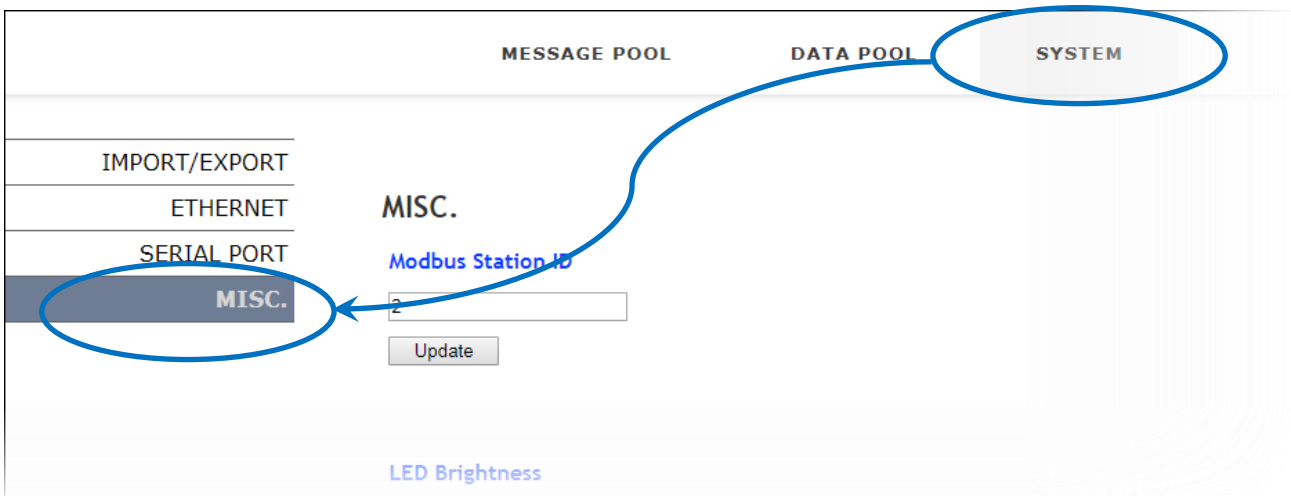





## **3.2. PROFIBUS configuration**

In chapter 3.2, we will teach the user how to set the communication between PROFIBUS master and IKAN-PFB display. Please refer and finish all the PROFIBUS settings from chapter 3.2.1 to chapter 3.2.6. Additionally, PROFIBUS master has its own PROFIBUS configuration tool. Therefore, PROFIBUS configuration has a little difference in different PROFIBUS configuration tool. Here we use Siemens PLC (CPU315-2PN/DP) and SIMATIC STEP 7 in this manual.

### 3.2.1. PROFIBUS wire connection.

#### 1. Wire connection:

The PROFIBUS interface of the GW-7552-B / GW-7552-M is a DB9 female connector. The connector uses the standard PROFIBUS 9 pin assignment. It is recommended to use a standard PROFIBUS cable and connector (DB9 male). It is only needed to use D-type connector via PROFIBUS cable to connect PROFIBUS master station and IKAN-PFB display and other PROFIBUS devices, as shown in the below.

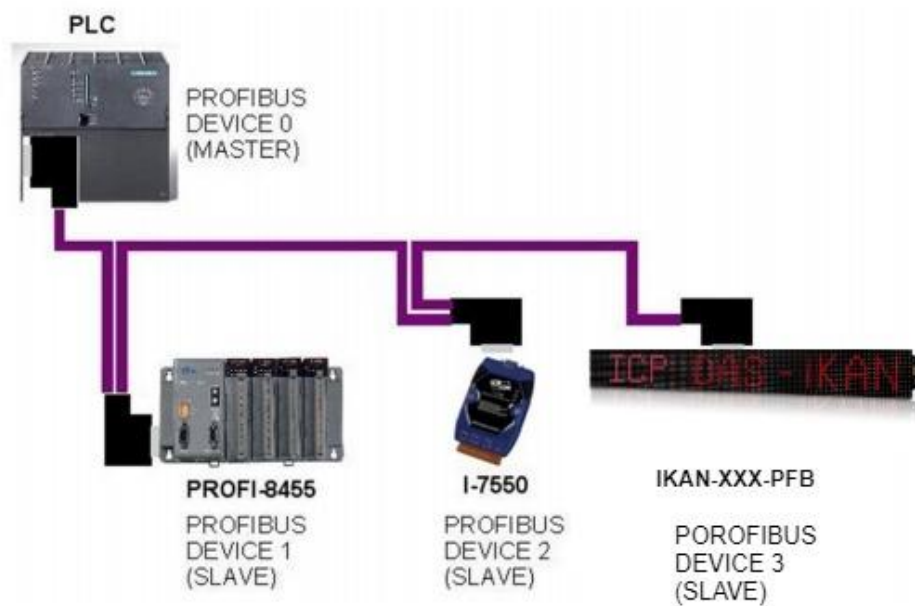

#### 2. PROFIBUS DB9 Female Connector

Pin	Name	Description
1	-	N/A
2	-	N/A
3	B	Non-inverting Bus Line
4	ISODE	Isolated DE output for use in PROFIBUS applications where the state of the isolated drive enable node needs to be monitored.
5	GND	Power supply ground for the first node and the last node
6	VP	+5V Power Supply for the first node and the last node
7	-	N/A
8	A	Inverting Bus Line
9	-	N/A

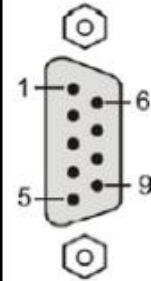

### 3. Terminal resistor:

In order to minimize the reflection effect of signal transmission, both ends (first node and last node) of a PROFIBUS segment needs to be equipped with an active terminal resistor. A standard PROFIBUS connector is usually already equipped with a terminal resistor. The user therefore only has to switch on the resistor of the devices stationed at the ends of a segment, as shown in the two picture below.

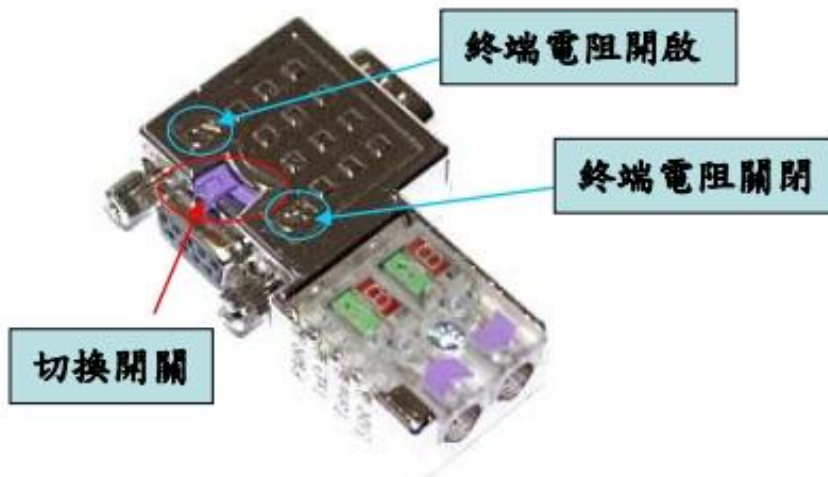

PROFIBUS connector

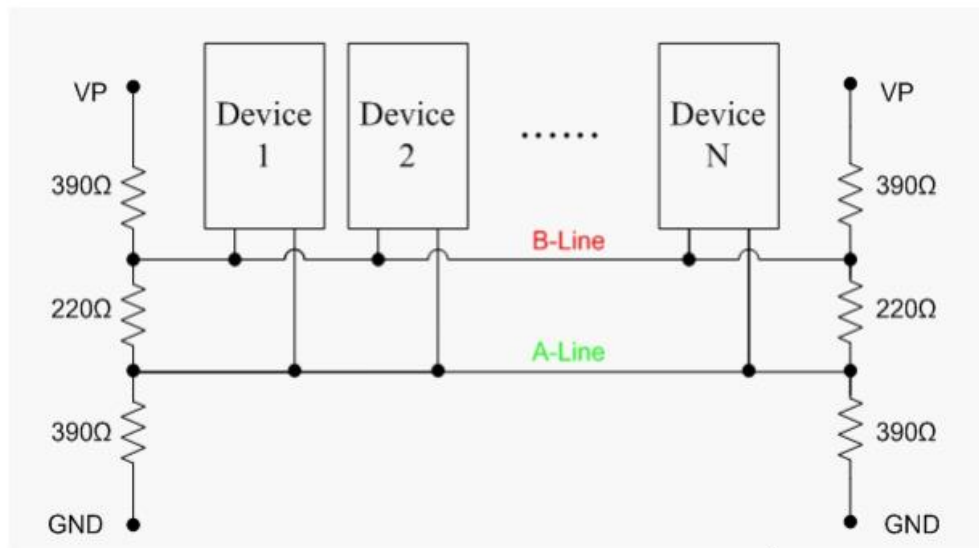

PROFIBUS connection

The number of stations in a PROFIBUS network is restricted to 126. According to the PROFIBUS specification up to 32 stations are allowed per segment. A repeater has to be used to link the bus segments.

### 3.2.2. GSD file

The parameters (ex: baud rate, message length, number of input / output data and etc) of each PROFIBUS DP device are described in a GSD file. The GSD file of the IKAN-PFB can be downloaded from the following link.

**Add the link of IKAN-PFB's GSD file here.**

NOTE:

Before the user install the GSD file, the user needs to create the new project in PROFIBUS configuration tool. If the user doesn't know how to create the new project in PROFIBUS configuration tool, please refer to Appendix A.3.

1.The example of installing the GSD file.

(1) Copy the GSD file(IKAN0c0d.gsd) to the destination folder.

(2) Create the new project in SIMATIC STEP 7 and double click "Hardware".

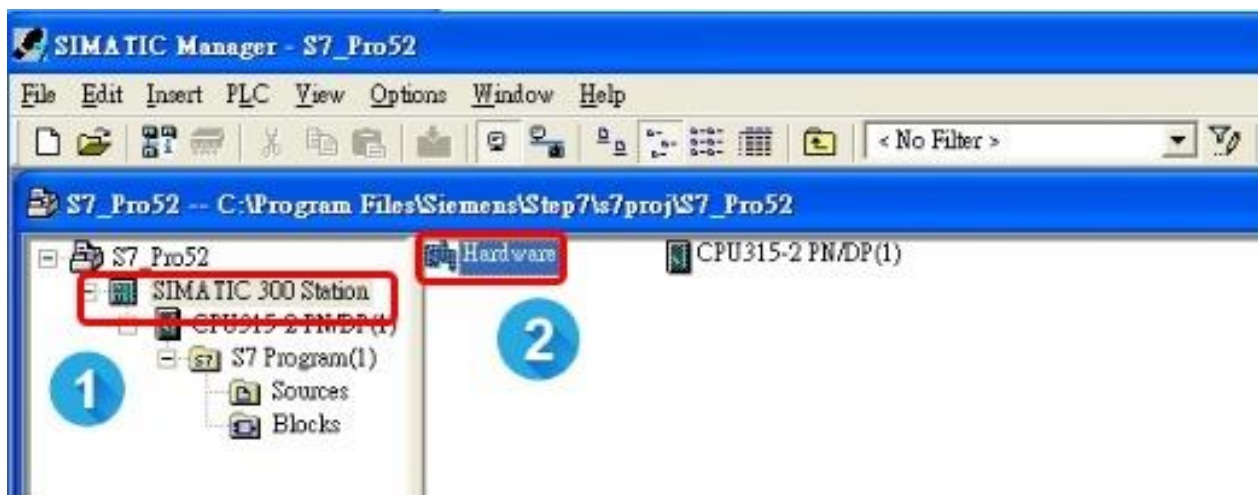

(2) Click "Option" and "Install GSD file" in HW Config.

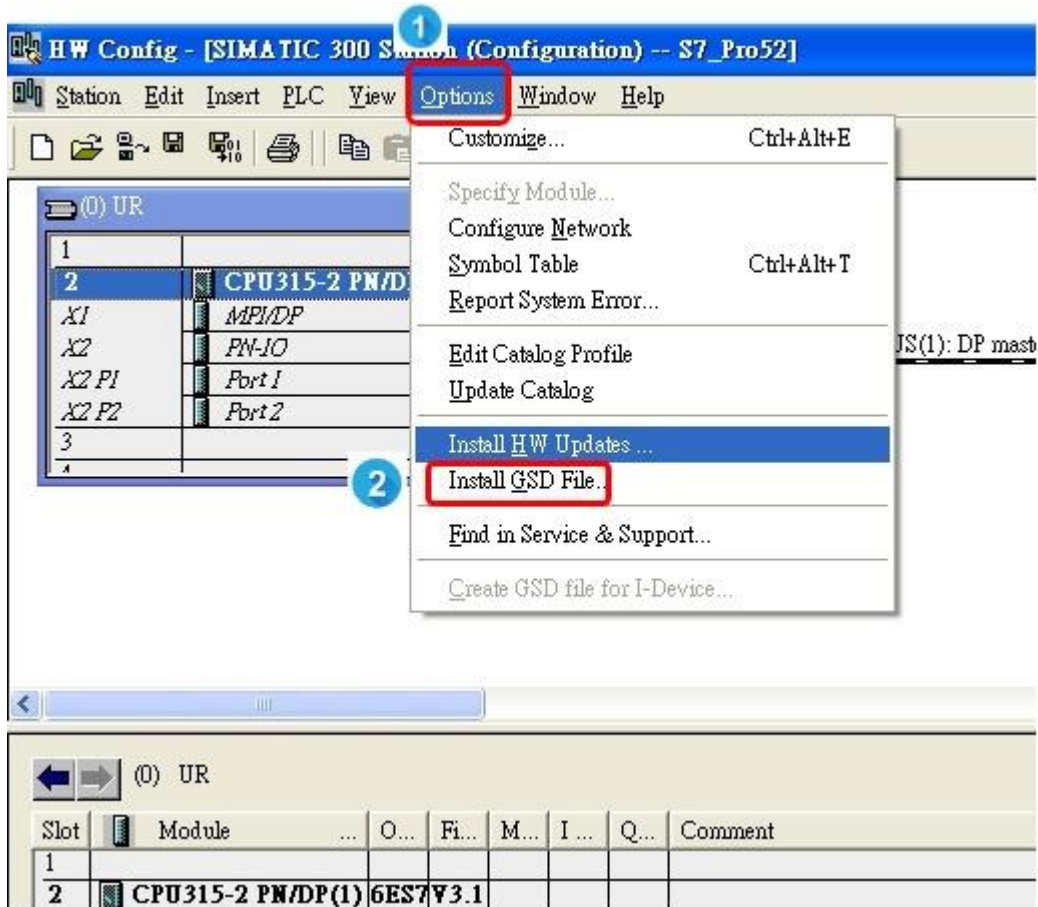

(3) Click "Browse" to choose where the GSD file located.

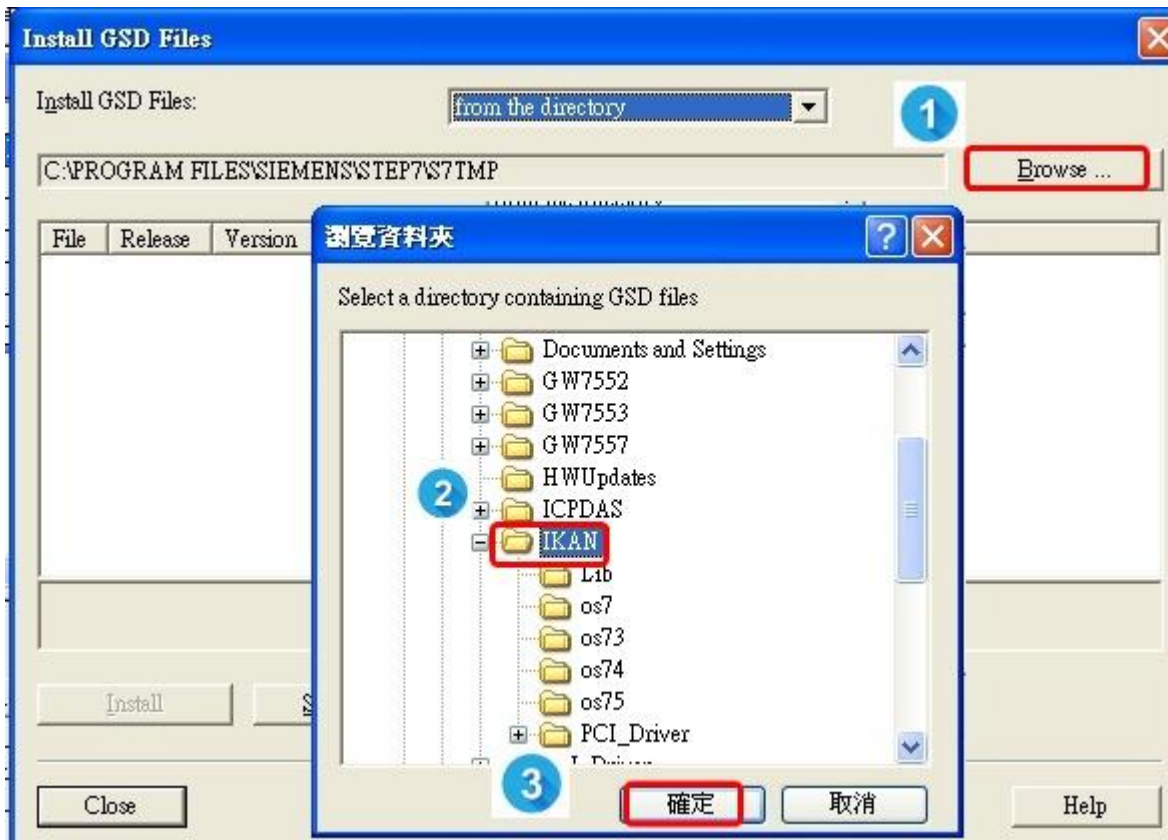

(4) Select the GSD file(IKAN0c0d.gsd) and click "Install".

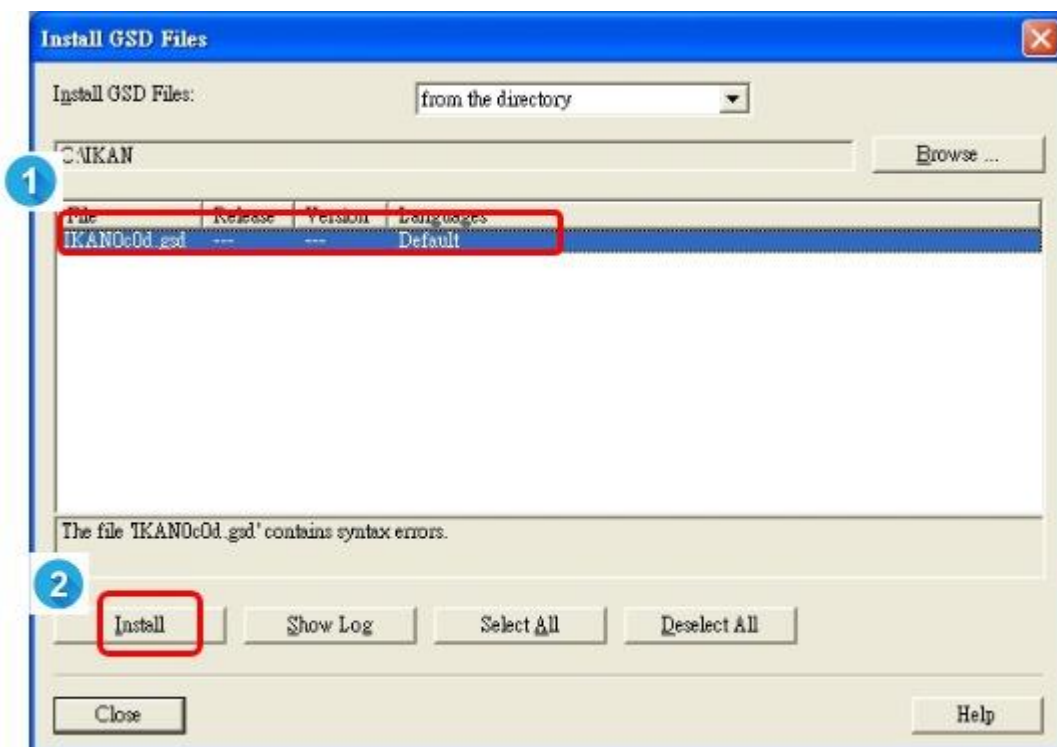

(5) Check if the IKAN-PFB can be found, if yes then IKAN-PFB is successfully added.



HW Config - [SIMATIC 300 Station (Configuration) -- S7\_Pro52]

Station Edit Insert PLC View Options Window Help

(0) UR	
1	
2	CPU315-2 PN/DP(1)
X1	MP/DP
X2	PN-IO
X2 P1	Port 1
X2 P2	Port 2
3	
4	

PROFIBUS(1): DP master system (

(1) IKAN-P  
DP-NORM

Find:   
Profile: Standard

- PROFIBUS DP
  - Additional Field Devices
    - Switching Devices
    - IO
    - Gateway
      - AS-I
      - DP/DP Coupler
      - DP/RS232C Lin.
      - GW-7552
      - GW-7553(DPV1)
      - GW-7557
      - i-7550
      - IKAN-PFB**
      - DP/DP Coupler,

(1) IKAN-PFB

### 3.2.3. PROFIBUS device address

Before PROFIBUS system starts communication, the user needs to configure a PROFIBUS device address to IKAN-PFB display. The range of PROFIBUS device address is from 0 to 126. Please refer to the following steps to finish the setting of PROFIBUS device address.

1. Open the website of IKAN-PFB and configure a PROFIBUS device address (PROFIBUS ID) to IKAN-PFB.



2. Configure a PROFIBUS device address to IKAN-PFB in SIMATIC STEP 7.
  - a. Click IKAN-PFB icon and drag it to PROFIBUS DP master system.

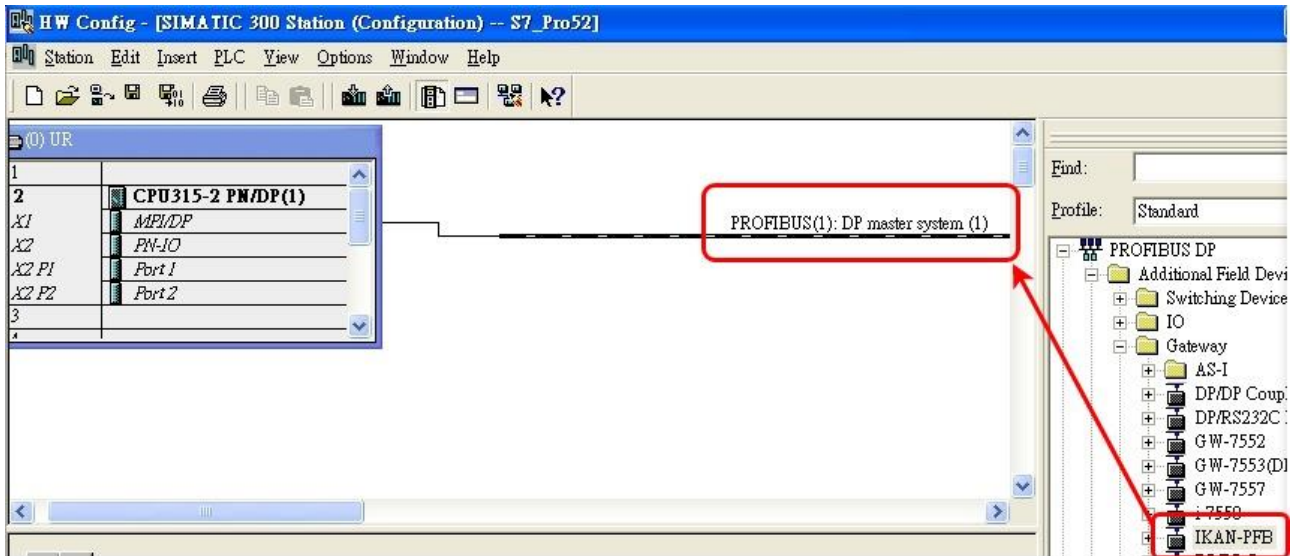

b. Set IKAN-PFB's address and click "OK".

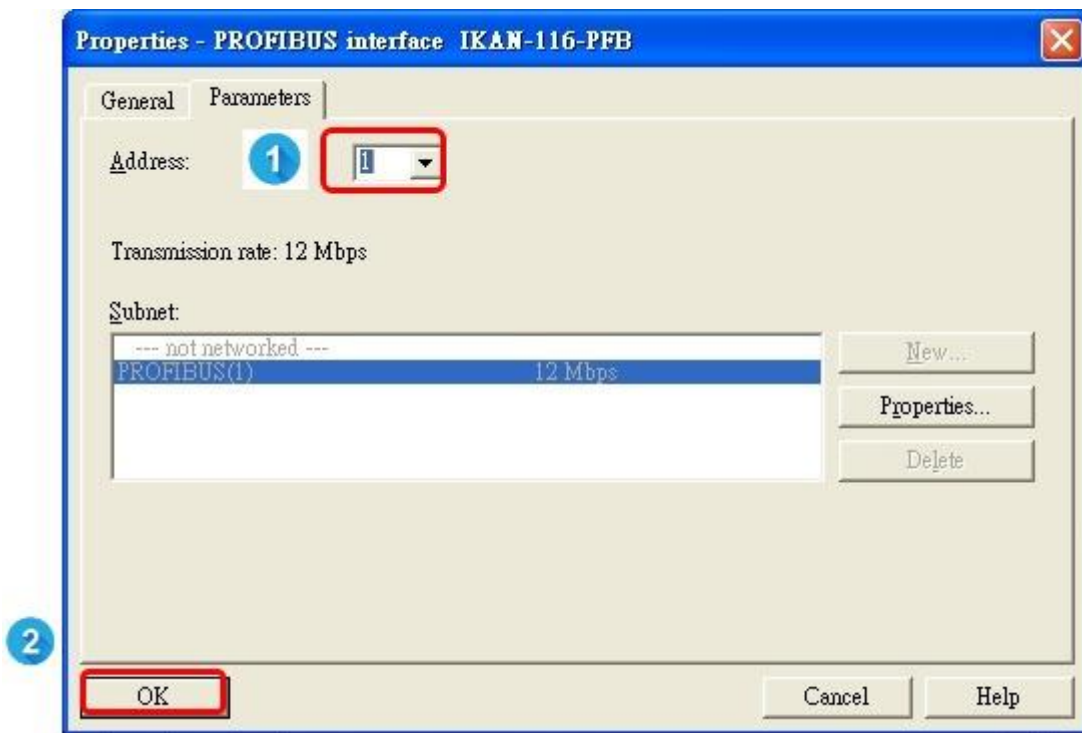

NOTICE:

The PROFIBUS device address of IKAN-PFB must be same in SIMATIC STEP 7 and the website of IKAN-PFB.



### 3.2.4. The configuration of the device parameters and the modules

After the user finishes the setting of PROFIBUS device address of IKAN-PFB, the user needs to configure the device parameters and module to IKAN-PFB display. IKAN-PFB has one device parameter and one module. Please refer to the following step to configure device parameters and module.

#### 1. The device parameters of IKAN-PFB

##### (1) The description of the device parameters of IKAN-PFB

- Clear Diagnostic Data: ON/OFF

PS:

- When "Clear Diagnostic Data" is ON, IKAN-PFB won't send any diagnostic message when it occurs error. (Please refer to chapter 3.2.7 about the diagnostic data)

(2) The example of configuring the device parameters

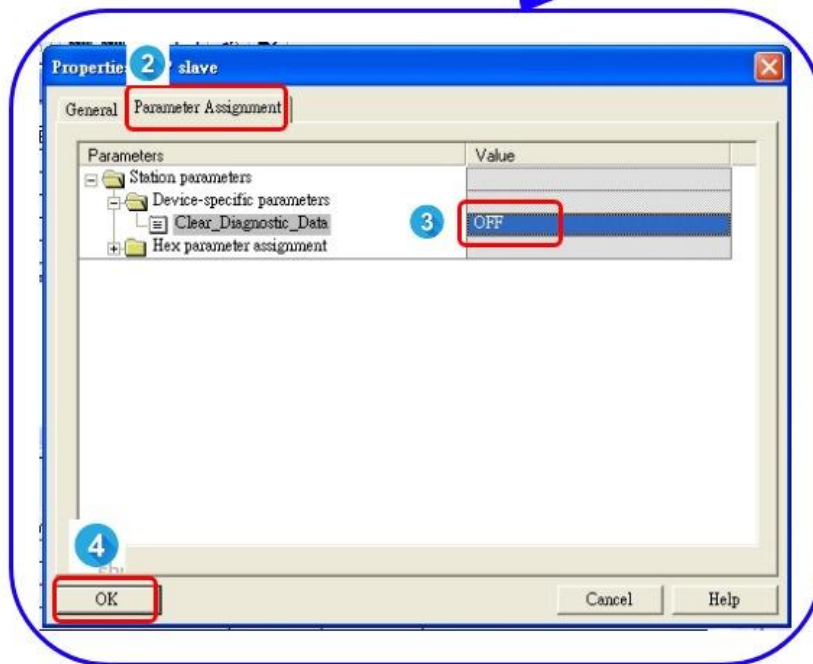
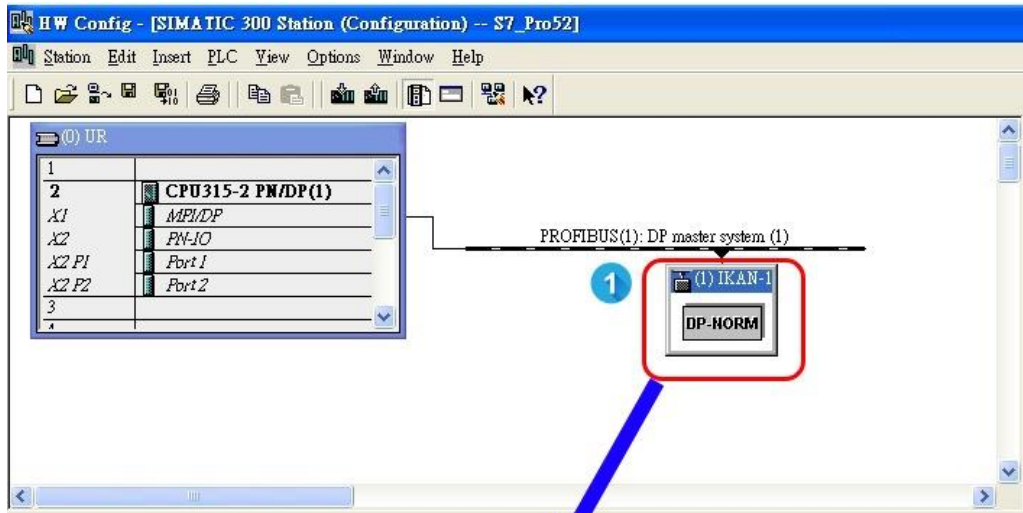

1	Double click "IKAN-PFB"
2	Select "Parameter Assignment"
3	configure the device parameters
4	Click "OK"

## 2. The module of IKAN-PFB: System setting module

### (1) The description of System setting module

- PROFIBUS output data length: 240 Bytes
- PROFIBUS input data length: 240 Bytes

### (2) The example of configuring the module

The screenshot displays the SIMATIC Manager HW Config interface for a SIMATIC 300 Station. The main workspace shows a rack configuration with a CPU 315-2 PN/DP(1) and an IKAN-1 DP-NORM module connected to a PROFIBUS DP master system. A table below the workspace shows the configuration details for the IKAN-PFB module, including DP ID, Order Number, and I/Q addresses. The right-hand pane shows the component tree with 'System-setting' highlighted under the IKAN-PFB module.

Slot	DP ID	Order Number / Designation	I Address	Q Address	Comment
1	192	System-setting	0...63	0...63	
2	192	--> System-setting	64...127	64...127	
3	192	--> System-setting	128...191	128...191	
4	192	--> System-setting	192...239	192...239	
5					
6					

1

Click "IKAN-PFB"

2

Double click System setting module

3

Confirm that System setting module is added in IKAN-PFB

3. When the user finishes the configuration of the device parameters and module, please compile and download the setting to PROFIBUS master.

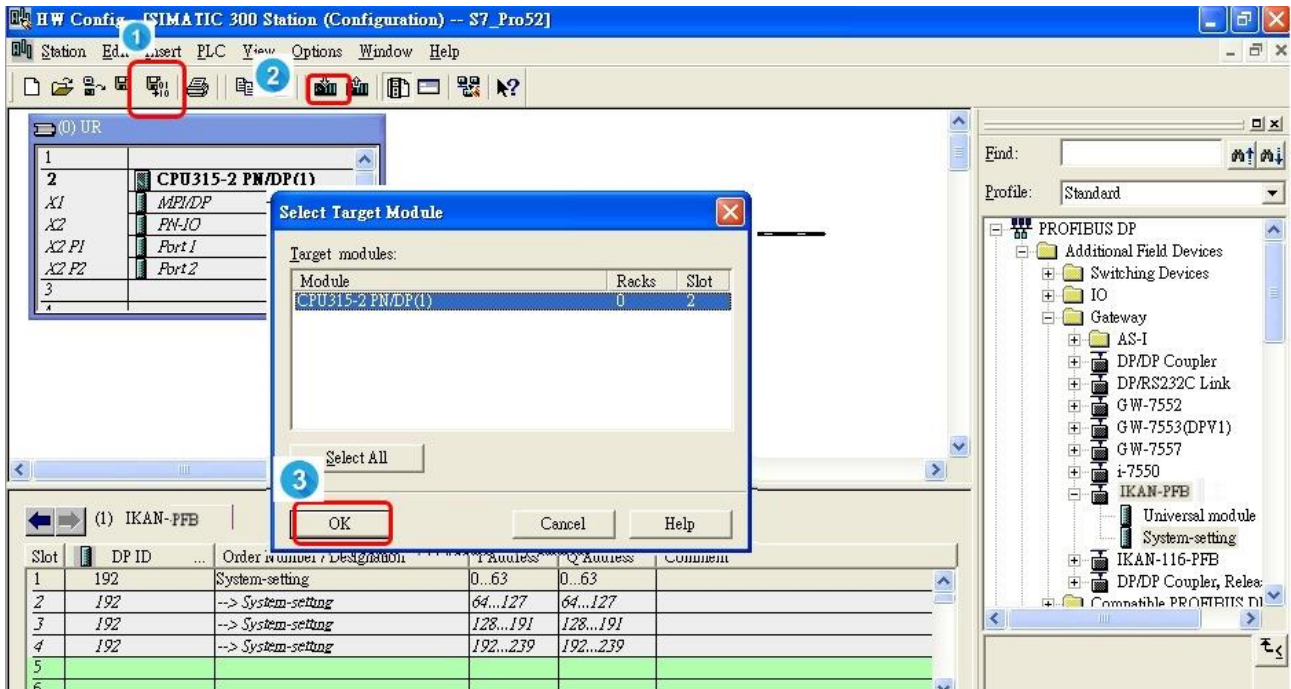



### **3.2.5. Confirm the connection between IKAN-PFB and PROFIBUS master**

When the user finishes all the setting from chapter 3.2.1 to chapter 3.2.4, it means that PROFIBUS configuration of IKAN-PFB is finished. The user can confirm the connection status in the website of IKAN-PFB and PROFIBUS master.

1. Confirm the connection status in SIMATIC STEP 7, if the status is “Module available and ok”, it means that the connection is OK.

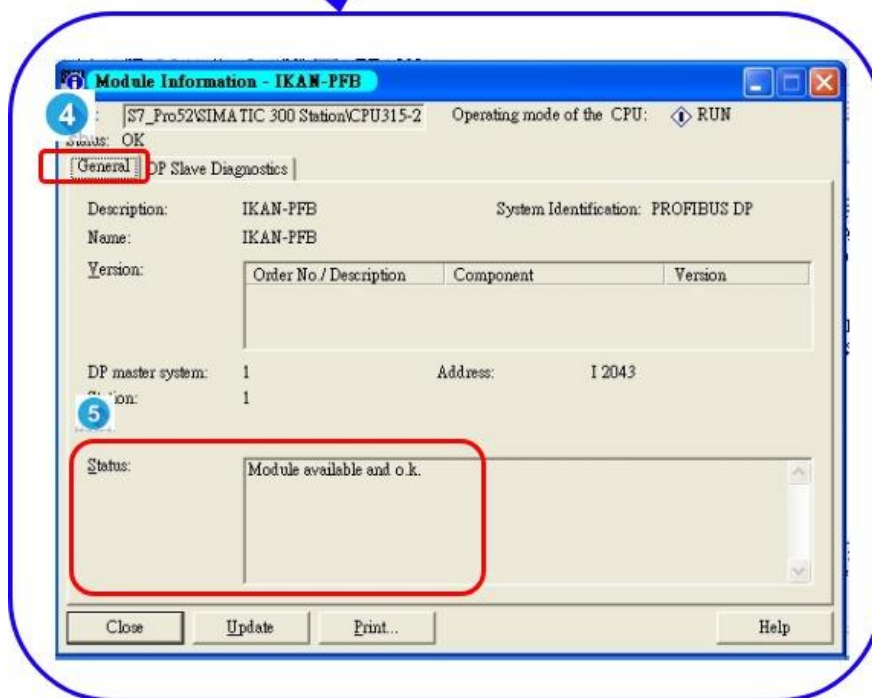
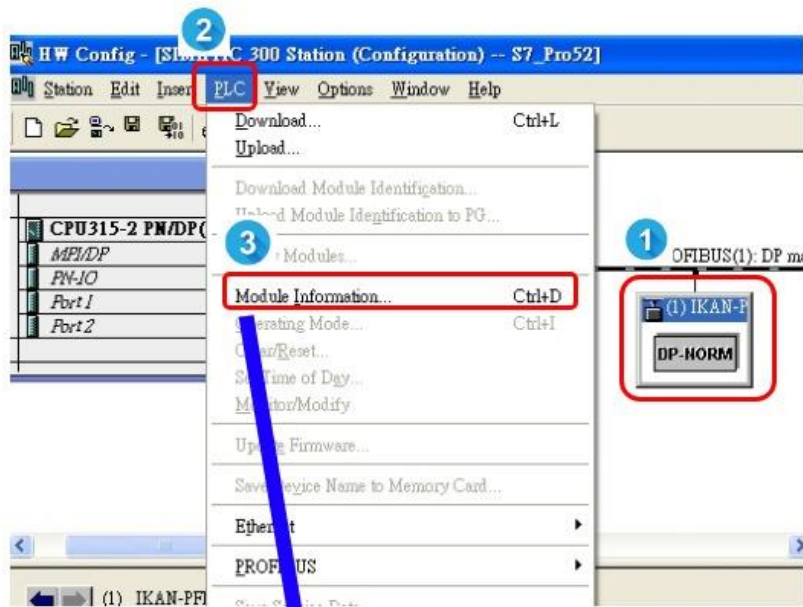

2. Confirm the connection status in the webpage of IKAN-PFB, if the PROFIBUS Connection is "Online", it means that the connection is OK.

1

MESSAGE POOL

DATA POOL

PROFIBUS

DIO

SYSTEM

EN

系中

2

### PROFIBUS Command Table

Profibus Connection

Online

### Brightness & Speed

Brightness & Speed

### Message List

Message List0	Message List1	Message List2	Message List3	Message List4	Message List5	Message List6

3

Brightness & Speed

Message List

Coil Variables

Integer Variables

Float Variables

DQ

DI

Preview

Update

### **3.2.6. The configuration of the control item**

IKAN-PFB provides the max length of input/output data which is 240/240 bytes, the user needs to choose the control items (e.g. LED brightness, message motion speed, and message list) and assign them an input/output data address in the website of IKAN-PFB. It notes that the total input/output data length can't exceed 240/240 bytes.

1. Webpage introduction:

2

PROFIBUS Command Table

1

Profibus Connection Online

Brightness & Speed

Brightness & Speed

→ the control item which is selected

Message List

Message List0	Message List1	Message List2	Message List3	Message List4	Message List5	Message List6
---------------	---------------	---------------	---------------	---------------	---------------	---------------

→ the control item which isn't selected

3

4

10 Brightness & Speed Message List Coil Variables Integer Variables Float Variables DO DI Preview Update

**PROFIBUS Command Table**

NO	Profibus Output Address	Description
1	0	Brightness & Speed
2	1	Message List_2
3	2	Coil Variables16~23
4	3~4	Integer Variables9
5	5~8	Float Variables0
6	9	DO0~1

NO	Profibus Input Address	Description
1	0	DIO~1

1	<p>PROFIBUS connection state.          Online: the connection between PROFIBUS master and IKAN-PFB is OK.          Offline: the connection between PROFIBUS master and IKAN-PFB is not OK.</p>
2	All the control items.
3	After the user clicks "Preview" button, "PROFIBUS Command Table" will be shown. The user can confirm the PROFIBUS output(input) address of each control items.
4	After the user clicks the "Update" button, the new configuration of "control items" will store into IKAN-PFB.
5	The PROFIBUS output(input) address of the control items in IKAN-PFB.
6	The description of the control items

## 2. Control items

Each kinds of control item has its own data type and data length, the control items are described in the below.

### (1) Output data

Type	Data length of each item
LED brightness and message motion speed	1 byte
Message list	1 byte
Coil-type variable	1 byte
Integer-type variable	2 bytes
Float-type variable	4 bytes

DO	1 byte
----	--------

(2) Input data

Type	Data length of each item
DI	1 byte

3. The example of configuring the control items.

- 1 | Click "PROFIBUS"
- 2 | Confirm that PROFIBUS Connection is online
- 3 | Select the control items
- 4 | Click "Update" button

4. Calculate the PROFIBUS Output(Input) address in PROFIBUS master.

The PROFIBUS output(input) address which is in PROFIBUS Command Table isn't correct, the user needs to confirm the first PROFIBUS output(input) address of IKAN-PFB in PROFIBUS master. The correct PROFIBUS output(input) address equals "the first PROFIBUS output(input) address of IKAN-PFB in PROFIBUS master" plus "the PROFIBUS output(input) addresses in PROFIBUS Command Table".

Example:

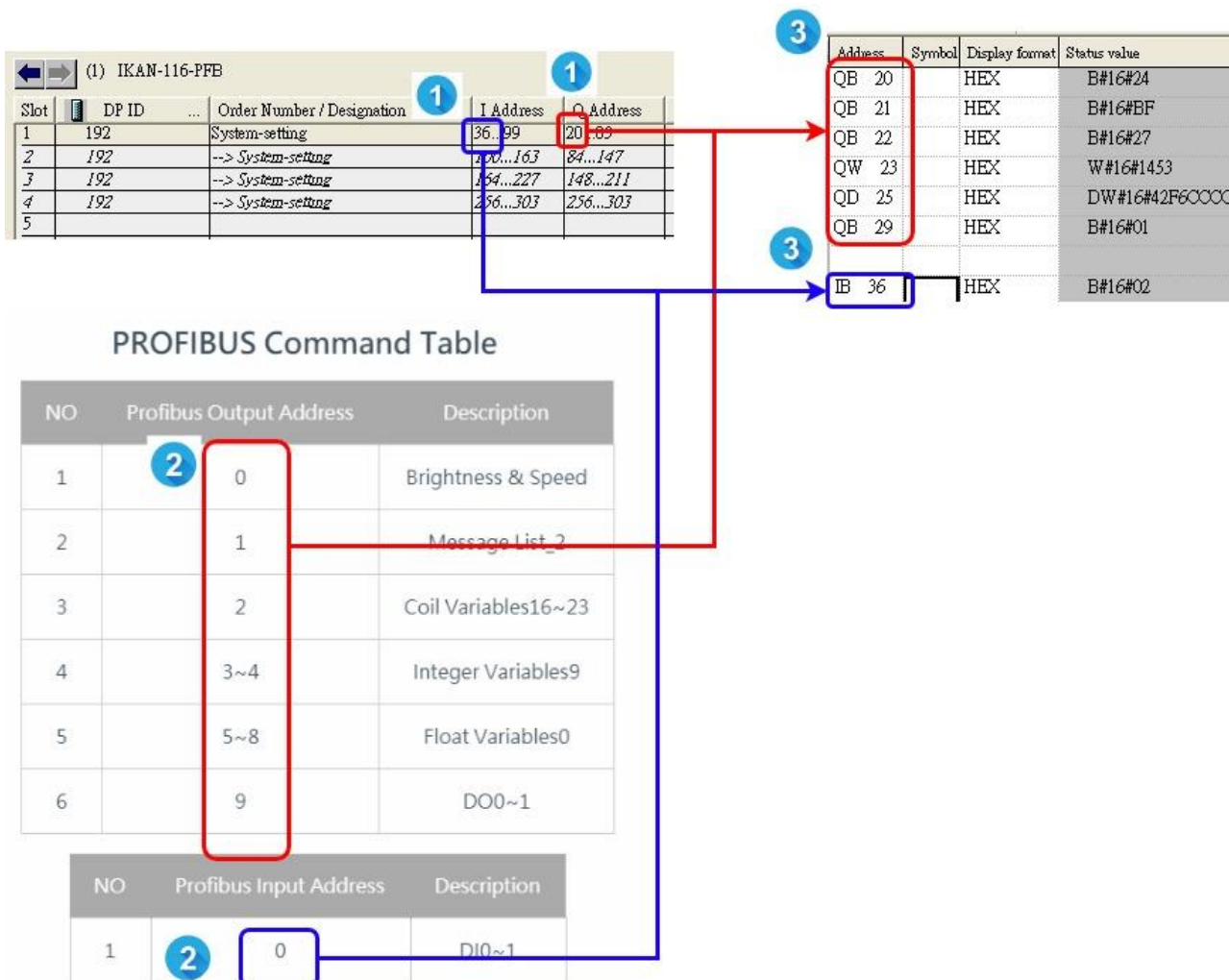



1

The first PROFIBUS output address of IKAN-PFB is 20.  
The first PROFIBUS input address of IKAN-PFB is 36.

---

2

The PROFIBUS output(input) address in  
"PROFIBUS Command Table" :

PROFIBUS output address:  
Brightness & Speed: 0  
Message List\_2: 1  
Coil Variables 16~23: 2  
Integer Variables 9: 3~4  
Float Variables 0: 5~8  
DO 0~1: 9

PROFIBUS input address:  
DI 0~1: 0

---

3

The PROFIBUS output(input) address in  
PROFIBUS master:

PROFIBUS output address  
Brightness & Speed:  $20+0=20$   
Message List\_2:  $20+1=21$   
Coil Variables 16~23:  $20+2=22$   
Integer Variables 9:  $20+3=23$  , 23~24  
Float Variables 0:  $20+5=25$  , 25~28  
DO 0~1:  $20+9=29$

PROFIBUS input address:  
DI 0~1 :  $0+36=36$

### 3.2.7. Diagnostic message

When IKAN-PFB occurs error, IKAN-PFB will send the diagnostic messages to PROFIBUS master. The diagnostic messages are described in the below.

1. Diagnostic message:

- IKAN No Response ! (0x64)

PS:

- IKAN No Response !: When IKAN-PFB internal communication occurs error, IKAN-PFB will send this diagnostic message to PROFIBUS master. The user can clear this diagnostic message first by changing the device parameters of IKAN-PFB (Set "Clear Diagnostic Data" ON), and check if IKAN-PFB can work normally. If IKAN-PFB still can't work normally, please contact with technical staff of ICP DAS.

### 3.3. eSearch Utility

eSearch utility is a program specifically made for the use of products rooted with ICP DAS MiniOS7.

Its main functions are to facilitate updating firmware, configuring the Ethernet parameters such as IP address, subnet mask and gateway etc., or updating firmware. The eSearch Utility is developed for searching ICP DAS Ethernet I/O modules based-on MiniOS7 which are connected to the same subnetwork as the Host PC, configuring the Ethernet parameters such as IP address, subnet mask and gateway etc., or updating firmware.



The eSearch Utility can be obtained from:

<http://ftp.icpdas.com/pub/cd/tinymodules/napdos/software/esearch/>

### 3.3.1. Configuring the IP Address

The IP address can be changed. To change the IP address, follow the instructions given below.

1. Launch the **eSearch utility** and click the **Search Server** button

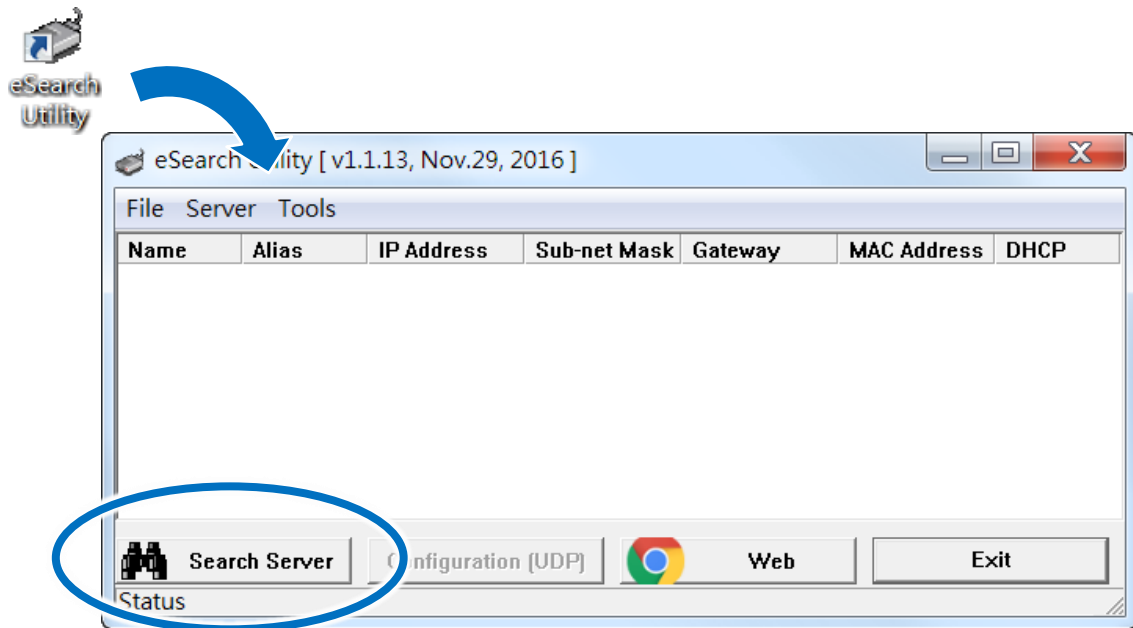

2. Once the search process has completed, double-click the name of iKAN display to open the **Configure Server (UDP)** dialog box

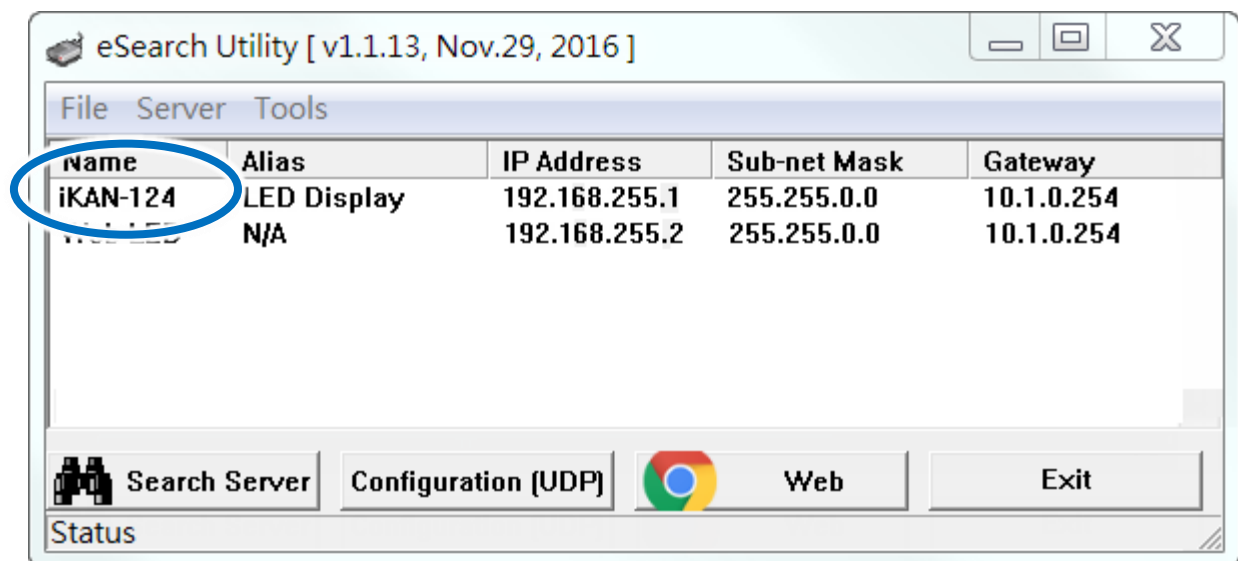

3. Enter the relevant values for the IP Address, Subnet Mask and Gateway, etc., and then click the **OK** button. The new settings for the iKAN display will take effect within 2 seconds.

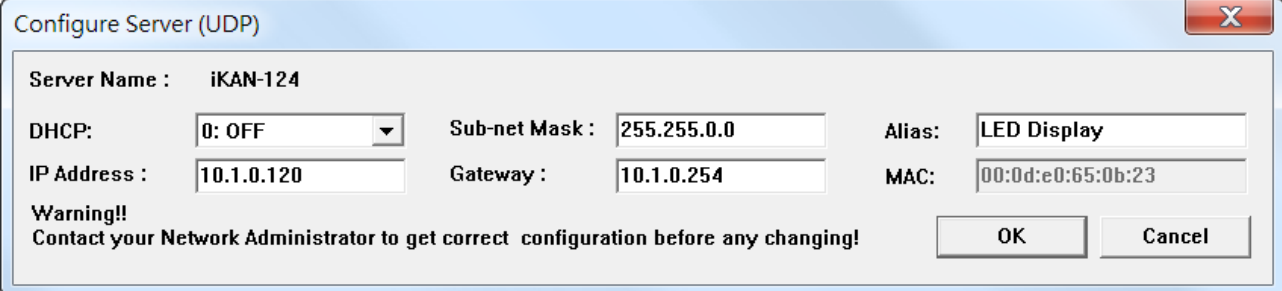

Configure Server (UDP)

Server Name : iKAN-124

DHCP: 0: OFF      Sub-net Mask : 255.255.0.0      Alias: LED Display

IP Address : 10.1.0.120      Gateway : 10.1.0.254      MAC: 00:0d:e0:65:0b:23

Warning!!  
Contact your Network Administrator to get correct configuration before any changing!

OK      Cancel

### 3.3.2. Sending the Modbus Command to iKAN

The eSearch Utility has 2 embedded configuration tools, Modbus RTU Master and Modbus TCP Master, which can be used to send the Modbus command to the iKAN display.

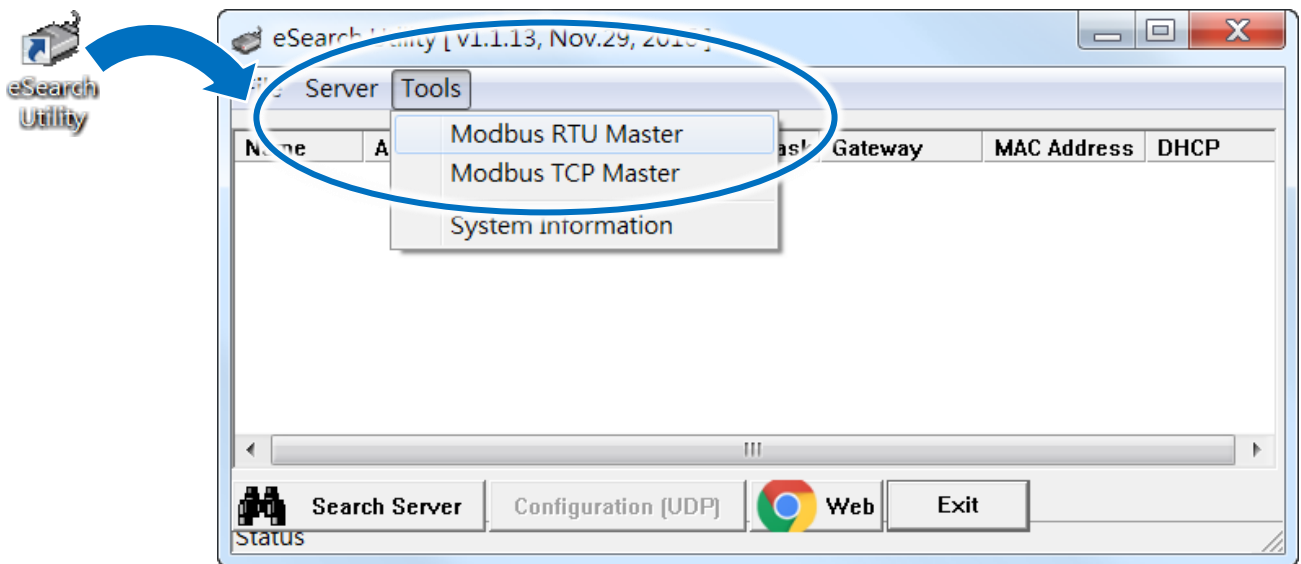

The **Modbus RTU Master** tool can be used to send Modbus message to read or write I/O values via the COM port.



The **Modbus TCP Master** tool can be used to send Modbus message to read or write I/O values via the Ethernet.





### 3.3.2.1. Using Modbus RTU Command to Configure the iKAN display

Before using the Modbus RTU Command tool, iKAN must be configured in Modbus configuration mode. For more information on how to set the iKAN display in Modbus configuration Mode, please refer to Appendix A.1. How to set the iKAN display in Modbus Configuration Mode.

1. Select the **Modbus RTU Master** from the **Tools** menu
2. Select the COM Port and Baud Rate from the respective drop-down menus, and then click the **Open** button

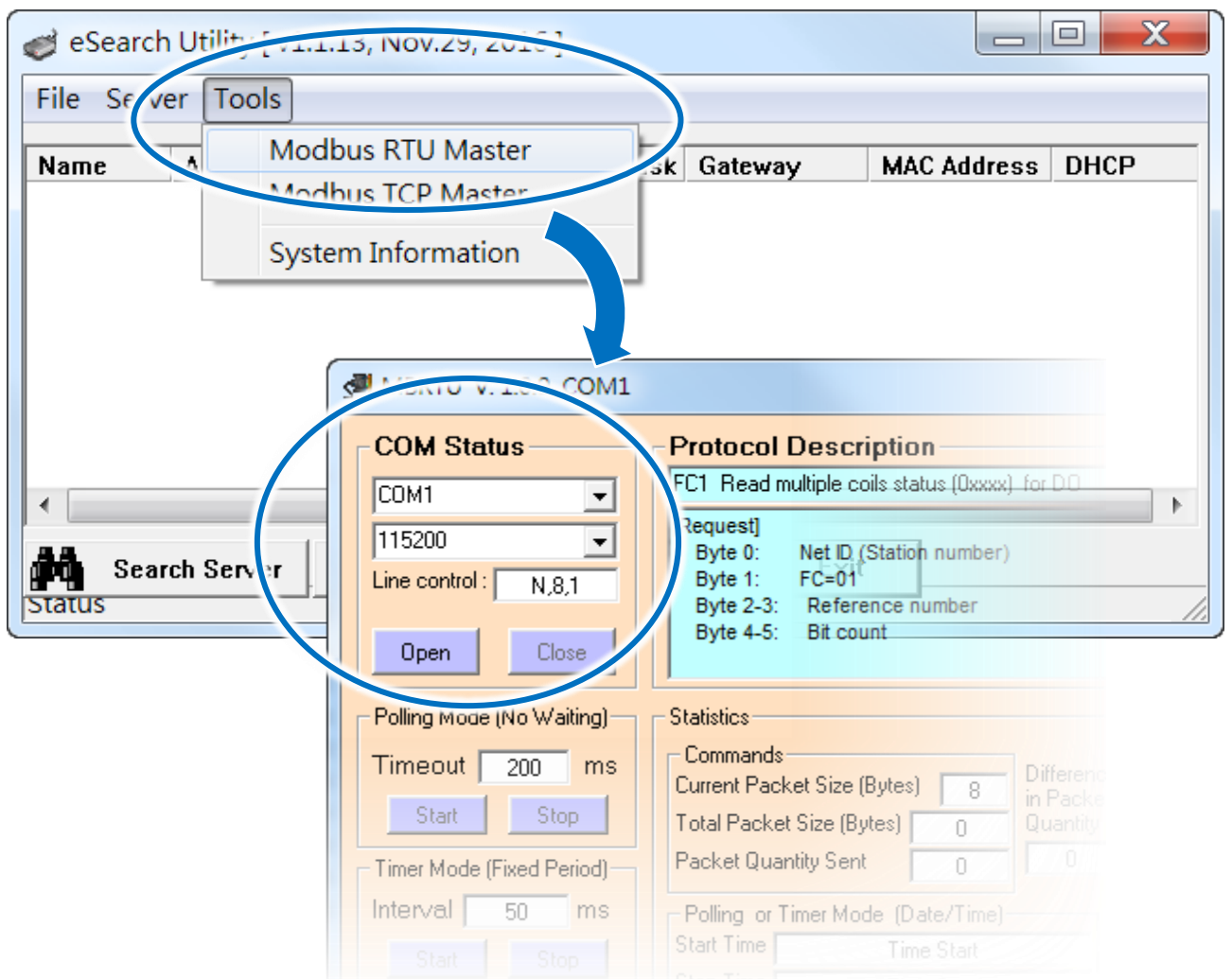



3. Enter a command in the command line field and then click the **Send Command** button to transmit the command

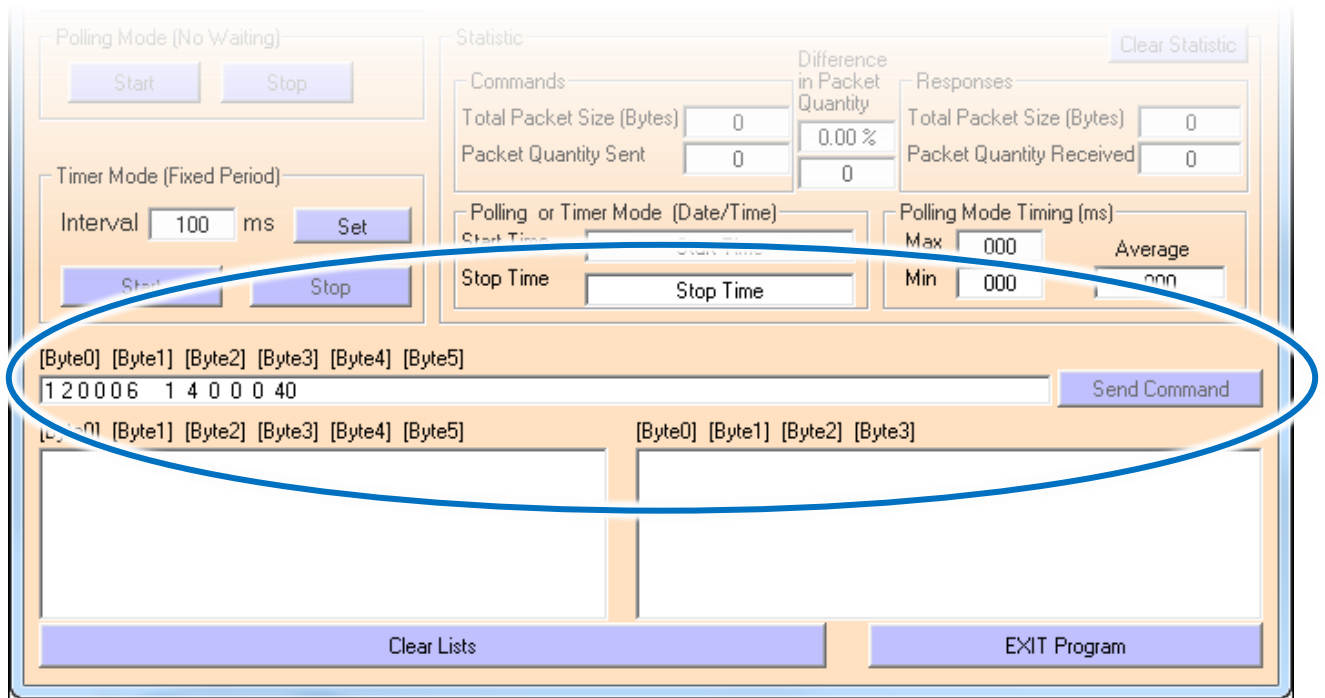

4. The command will be displayed on the left-hand side of the text box area, and the response will be shown on the right-hand side of the text box area

### 3.3.2.2. Using Modbus TCP Command to configure the iKAN display

Before using the Modbus TCP Command tool, iKAN must be configured in Modbus configuration mode. For more information on how to set the iKAN display in Modbus configuration Mode, please refer to Appendix A.1. How to set the iKAN display in Modbus Configuration Mode.

1. Select the **Modbus TCP Master** from the **Tools** menu
2. Enter the IP address and the Port number in the respective text fields and then click the **Connect** button

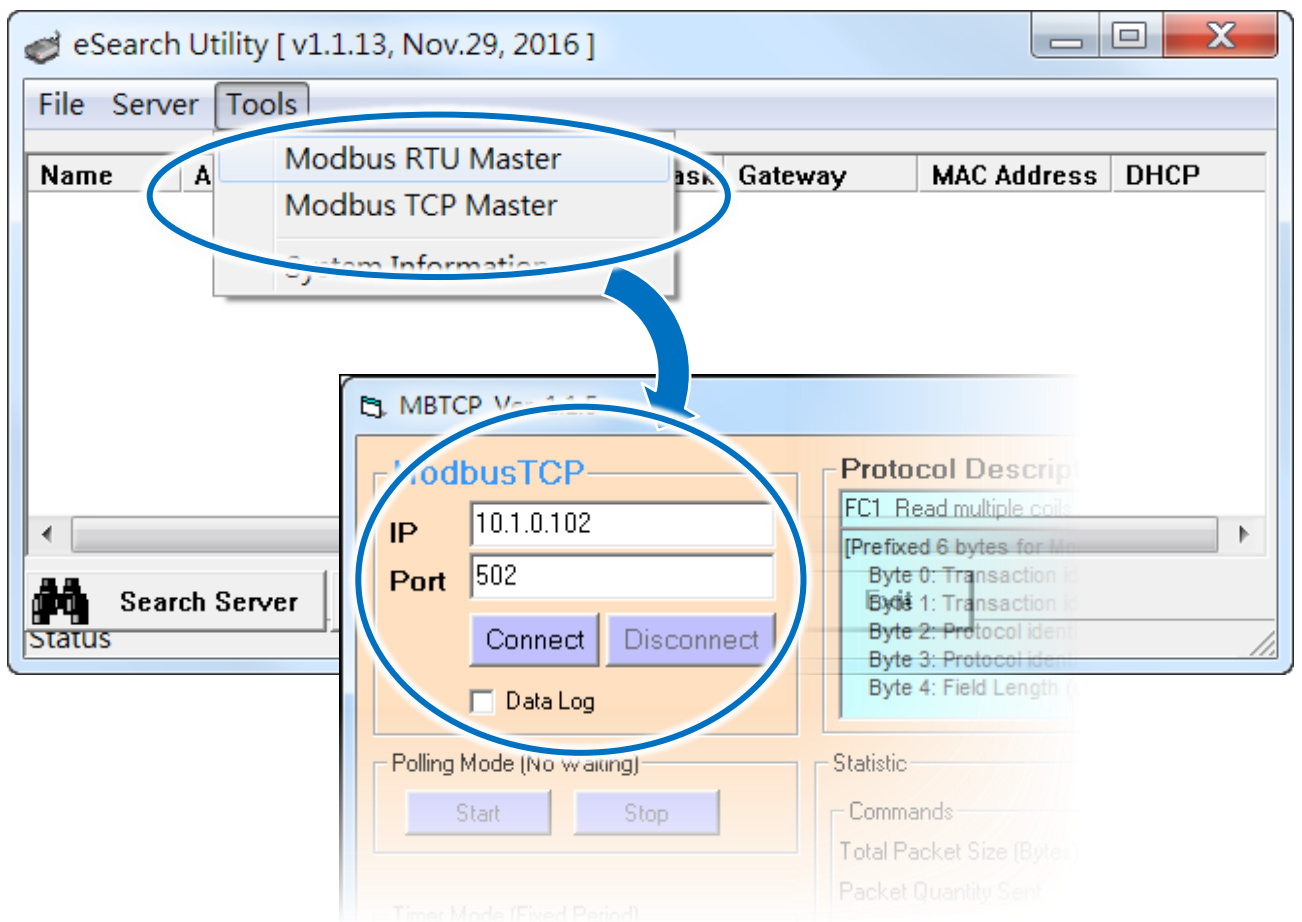

3. Enter a command in the command line field and then click the **Send Command** button to transmit the command

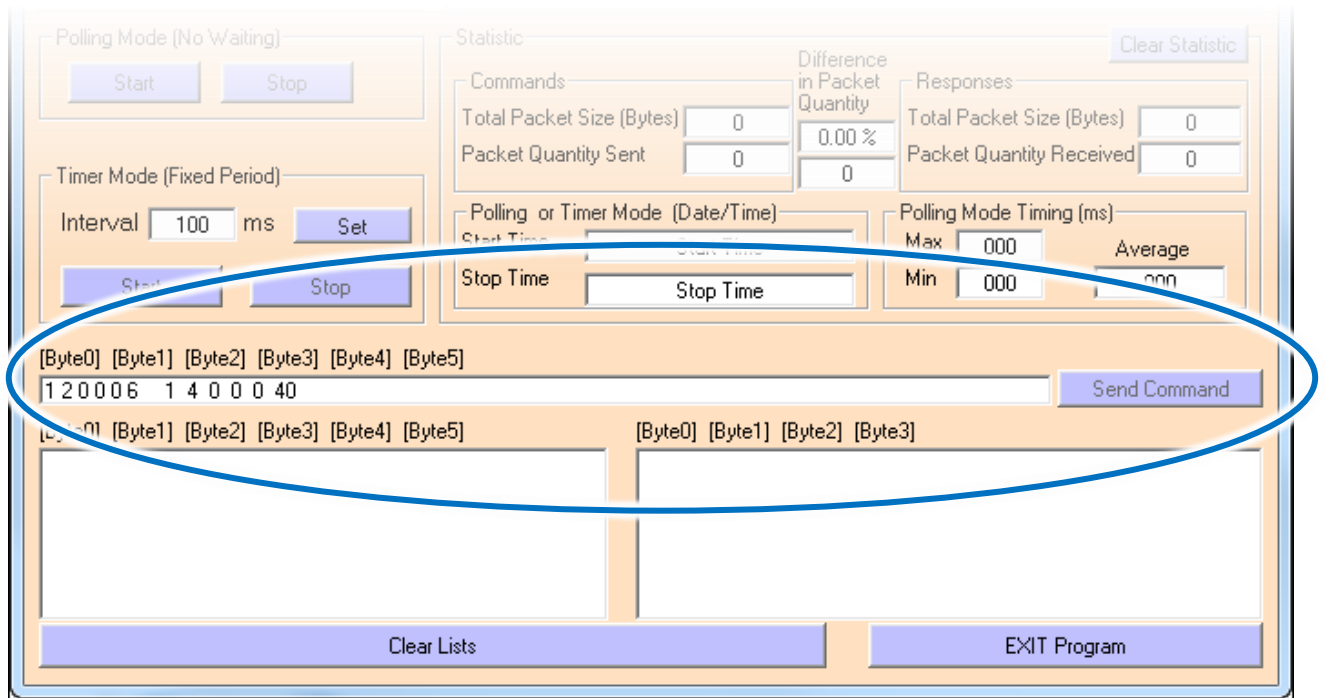

4. The command will be displayed on the left-hand side of the text box area, and the response will be shown on the right-hand side of the text box area

## **4. Message, LED Brightness, Message Motion and Speed**

## **4.1. LED Brightness and Message motion speed**

### 4.1.1. Introduction

5 levels of brightness and 10 levels of message motion speed are adjustable on the iKAN-PFB display. Smaller setting numbers are paired with brighter and higher scrolling speeds. To adjust the LED brightness and message motion speed, follow the instructions given below.

Item	Bit position	Value range	Description
LED Brightness	Bit0~bit3	0~4	Brightest:0 Darkest:4
Message motion speed	Bit4~bit7	0~9	Fastest:0 Slowest:9

## 4.1.2. Adjusting LED Brightness and Message motion speed

1. Click the **PROFIBUS** menu and select the “Brightness & Speed”, and press update button.

The screenshot shows a web-based interface for PROFIBUS configuration. At the top, there is a navigation bar with tabs: MESSAGE POOL, DATA POOL, PROFIBUS (highlighted with a red box and a blue circle '1'), DIO, and SYSTEM. To the right of the navigation bar are buttons for 'IN' and a menu icon. Below the navigation bar, the main content area is titled 'PROFIBUS Command Table'. On the right side of this section, it says 'Profibus Connection' with a green 'Online' status indicator. Underneath, there is a sub-section titled 'Brightness & Speed' (highlighted with a blue circle '2'). Below this title is a blue rectangular button labeled 'Brightness & Speed' (highlighted with a red box). Further down is a 'Message List' section containing seven tabs: Message List0, Message List1, Message List2, Message List3, Message List4, Message List5, and Message List6 (highlighted with a blue circle '3'). At the bottom of the interface is a dark navigation bar with several menu items: '1 Brightness & Speed', 'Message List', 'Coil Variables', 'Integer Variables', 'Float Variables', 'DO', and 'DI'. On the far right of this bar are two buttons: 'Preview' and 'Update' (highlighted with a red box).

- 1 | Click "PROFIBUS" menu

---

- 2 | Select "Brightness & Speed"

---

- 3 | press "Update" button

2. Modify the value 0x24 in PROFIBUS master. You can see the LED brightness is 4, and the message motion speed is 2.

Address	Symbol	Display format	Stat_	Modify value
QB 20		HEX	B#16#24	B#16#24
QB 21		HEX	B#16#00	B#16#00
QB 22		HEX	B#16#00	
QB 23		HEX	B#16#00	

LED Brightness  
This function is used to set the LE  
4 ▼

Message Moving Speed  
This function is used to set the m  
2 ▼

- 1 Enter the value 0x24
- 2 LED Brightness is 4, Message Moving Speed is 2

3. You can see the LED brightness and message motion speed on the web interface.

MESSAGE POOL DATA POOL PROFIBUS DIO SYSTEM 1

IMPORT/EXPORT ETHERNET SERIAL PORT MISC. 2

Misc.

#### LED Brightness

This function is used to set the LED brightness. Click the Update button to update the configuration on the module.

#### Message Moving Speed

This function is used to set the message moving speed. Click the Update button to update the configuration on the module.



4. The description of the value of "Brightness & Speed"

item	Brightness & Speed							
Bit position	7	6	5	4	3	2	1	0
Value (BIN)	0	0	1	0	0	1	0	0
Type	LED Brightness				Message motion speed			
Value (HEX)	2				4			

## 4.2. Message

The iKAN web configuration interface provides a convenient and simple interface for the user, easily managing the message content and its effect.

A maximum of 128 Common Messages can be stored on the iKAN-PFB series device, and each message can contain a maximum of 40 Unicode characters or 100 ASCII characters.

## 4.2.1. Editing and Managing Messages

The contents of each common message and instant message can be pre-configured individually via the **MESSAGE POOL** page on the web interface.

Select the message number which you would like to add, and then click the  button. The message item has been added to the message queue.

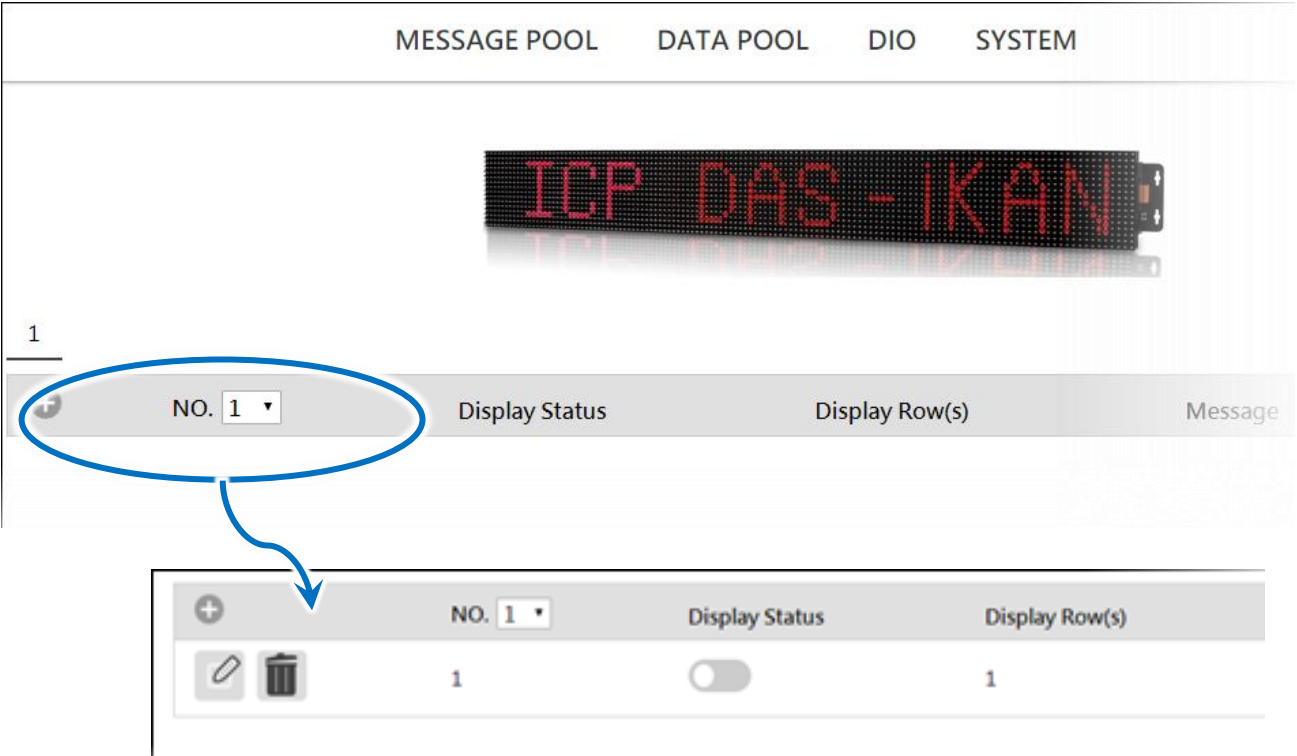

The screenshot shows the 'MESSAGE POOL' tab selected in a navigation bar. Below the navigation bar is a visual representation of a message on a display, showing the text 'ICP DAS - IKAN'. Below this is a table with one row. The first cell of the row contains a plus sign icon and a dropdown menu showing 'NO. 1'. A blue circle highlights this area, and a blue arrow points from it to a detailed view of a message item below. This detailed view shows a plus sign icon, a dropdown menu with 'NO. 1', a 'Display Status' toggle switch, and a 'Display Row(s)' field with the value '1'. Below these are two icons: a pencil (edit) and a trash can (delete).

+	NO. 1 ▾	Display Status	Display Row(s)
	1	<input type="checkbox"/>	1



There are 2 buttons in each message item.

 button is used to edit the message.

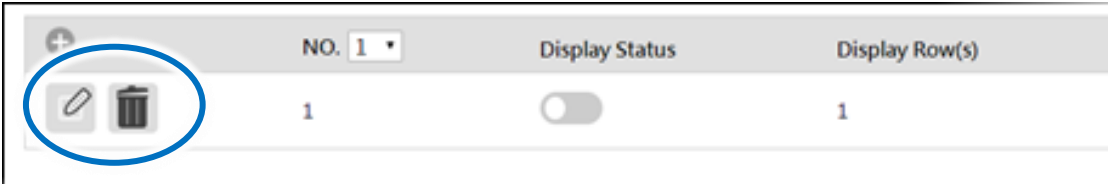
 button is used to delete the message.



A close-up of the message item controls from the previous screenshot. A blue circle highlights the edit (pencil) and delete (trash) icons.

+	NO. 1 ▾	Display Status	Display Row(s)
 	1	<input type="checkbox"/>	1

By default, the added message has no effect until you add parameters to the message form.

Click the  button to enter the message form

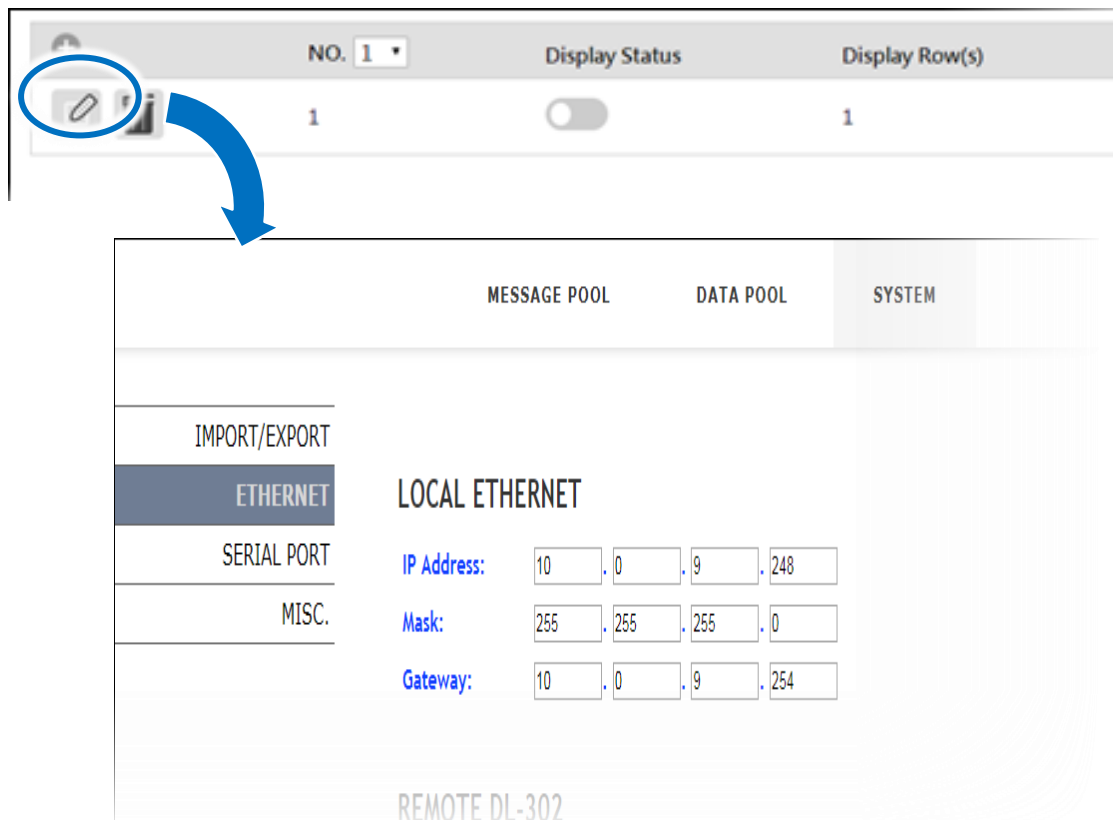

The details of these items are as follows:

- **Display Status \***

Enable the contents of the message to be displayed on the iKAN series device.

- **Instant \***

Set this message to be an instant message.

- **Message Moving Mode**

Specify the message moving mode.

- **Row(s)**

Specify the row for the message displayed.

- **Color\***

Specify the color for the message displayed.

- **Message**

Edit the contents of the message.

- **Update**

Allow the settings to take effect.

## Tips & Warnings

---



1. Instant messages have a higher priority than common messages, meaning that if any of the instant messages have been enabled, any scheduled common messages in the sequence will be ignored until all instant messages have been disabled.
  2. Each time the settings for a message are changed, you will need to click the respective **Update** button for that message.
  3. \* means this item can't be modified through the website of iKAN-PFB, it only can be modified through PROFIBUS master.
-

## 4.2.2. Modify the message item through PROFIBUS master

There are three message items which only can be modified by PROFIBUS master, Display Status, Instant, and Color. Before the user modifies those message items, he needs to select “Message List” and update in the PROFIBUS menu. Please refer to the following example.

Each message has its own “Message List”. E.g., if you want to modify the message items of message NO.1, select “Message List0”. If you want to modify the message items of message NO.2, select “Message List1”, and so on.

1. Click the **PROFIBUS** menu, and select “Message List” which message number you want to modify, and press update button. We select from Message List0 to Message List3 in this example.

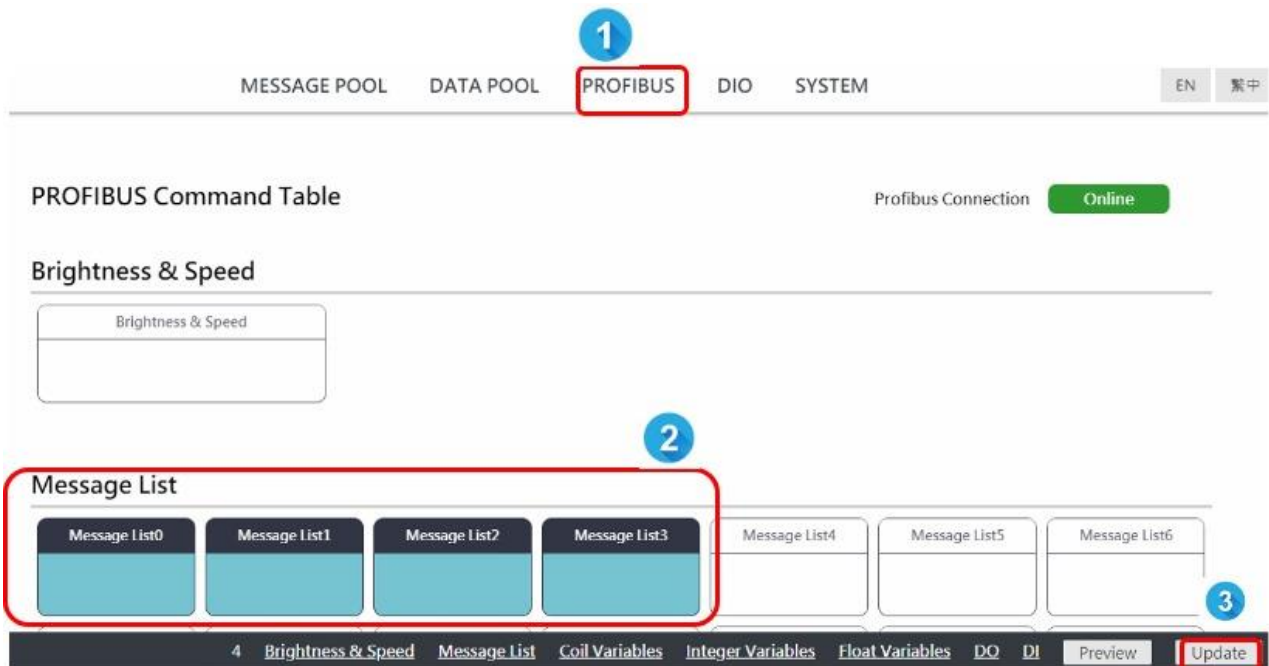

- 1 | Click "PROFIBUS" menu
- 2 | Select Message List 0~Message List 3
- 3 | Press "Update" button

2. Modify the value in PROFIBUS master, the users can see the message items which are modified.

**1**

	Address	Symbol	Display format	Status value	Modify value
1	QB 20		HEX	B#16#BF	B#16#BF
2	QB 21		HEX	B#16#DC	B#16#DC
3	QB 22		HEX	B#16#CB	B#16#CB
4	QB 23		HEX	B#16#80	B#16#80

The value of each Message List in PROFIBUS master

Message List\_0: 0xBF  
 Message List\_1: 0xDC  
 Message List\_2: 0xCB  
 Message List\_3: 0x80

**1**

**2**

The message status in IKAN-PFB webpage.

**2**

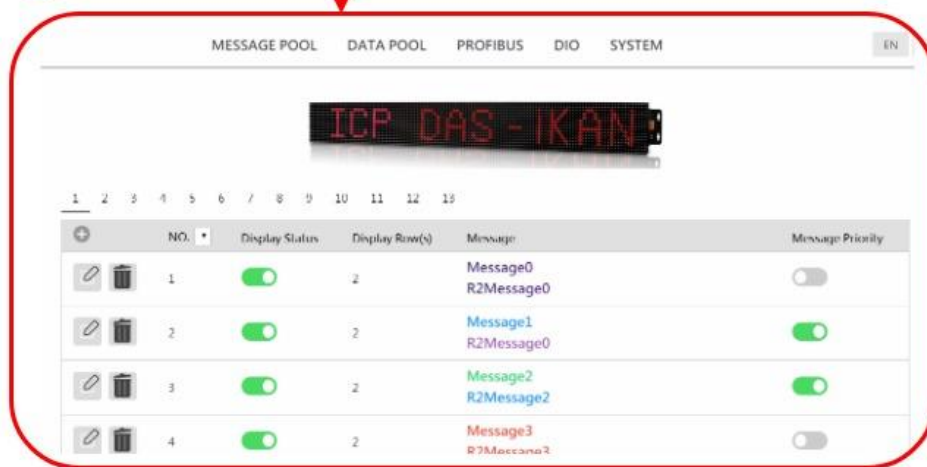

3. The description of the value of “message List”

(1) Data analysis

Item	Bit position	Value range	Description
Display status	Bit7	0~1	0: Disable 1: Enable
Instant	Bit6	0~1	0: Disable 1: Enable
Color	First row: bit3~bit5 Second row: bit0~bit2	0~7	0: Red 1: Green 2: Yellow 3: Blue 4: Purple 5: Sky Blue 6: White 7: Random

(2) Data analysis in the example

Item	Message List0							
Bit position	7	6	5	4	3	2	1	0
Value (BIN)	1	0	1	1	1	1	1	1
Type	Display status: enable	Instant: disable	Color(first row): Random			Color(second row): Random		
Value (HEX)	B				F			

Item	Message List1							
Bit position	7	6	5	4	3	2	1	0
Value (BIN)	1	1	0	1	1	1	0	0
Type	Display status: disable	Instant: enable	Color(first row): Blue			Color(second row): Purple		
Value (HEX)	D				C			

Item	Message List2							
Bit position	7	6	5	4	3	2	1	0
Value (BIN)	1	1	0	0	1	0	1	1
Type	Display status: enable	Instant: enable	Color(first row): Green			Color(second row): Blue		
Value (HEX)	C				B			

Item	Message List3							
Bit position	7	6	5	4	3	2	1	0
Value (BIN)	1	0	0	0	0	0	0	0
Type	Display status: enable	Instant: disable	Color(first row): Red			Color(second row): Red		
Value (HEX)	8				0			



### 4.2.3. Inserting System Variables into a Message

The iKAN series device allows data related to items such as the Ethernet configuration, the RTC value, and other information, to be inserted into a message as a system variable. The format for using a system variable in a message has a length of 5 bytes as follows:

1	2	3 to 5		
Delimiter Character	Variable Type	Address: 3-digit decimal number		
%	y: System variable	X	X	X

#### 4.2.3.1. Displaying the IP Address

Addresses 000 to 011 can be used to read the current IP, Mask, and Gateway address values. The following is an overview of how to read these addresses.

Address	Length	Description	Value Range	Attribute
000 : 003	4	The IP address for the iKAN series device	0 ~ 255	R
004 : 007	4	The Mask address for the iKAN series device	0 ~ 255	R
008 : 011	4	The Gateway address for the iKAN series device	0 ~ 255	R

For example, the following explains how to configure a message to display the IP address for the iKAN series device in message 1.

1. Select the message **No. 1**, and then click the  button

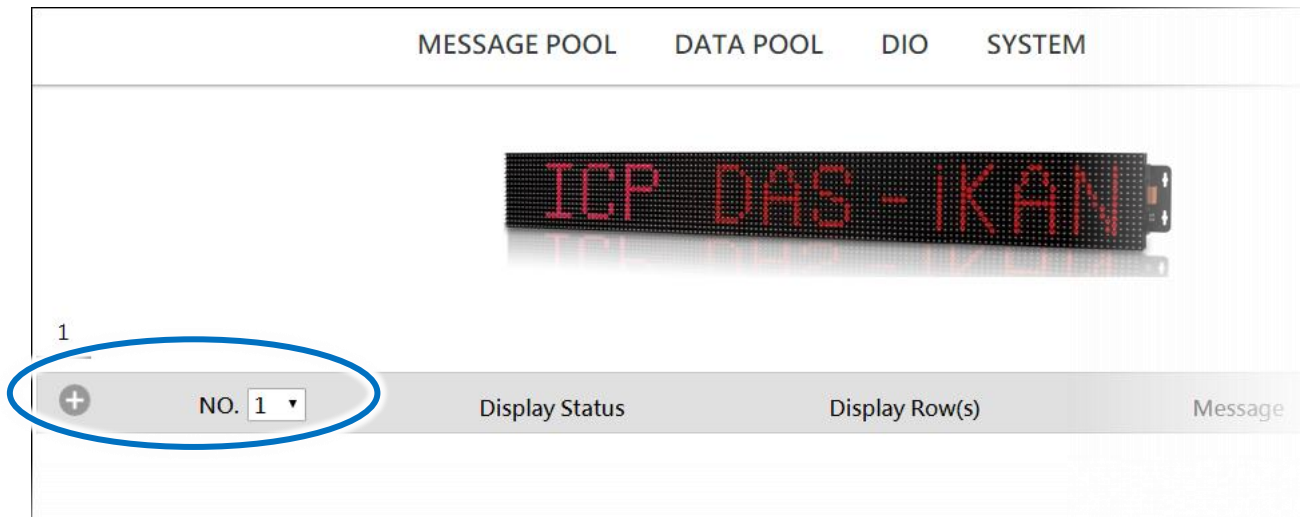

2. Click the  button

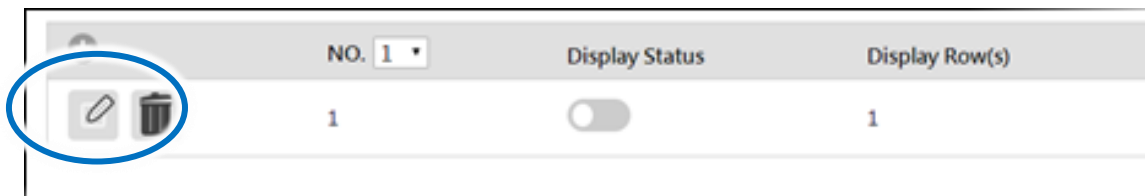

3. In the **No. 1** form, specify the following parameters:
- i. Check the **Display Status** checkbox
  - ii. Select the desired color from the **Color** drop-down menu
  - iii. Enter the following string in the **Message** text field:  
IP: %y000.%y001.%y002.%y003
  - iv. Click the **Update** button

NO. 1

Display Status  Instant

Message Moving Mode

Row(s)

Color

Message

The IP address for the iKAN series device will be shown on the display.

**IP: 10.1.0.108**

### 4.2.3.2. Displaying the Current Date and Time

Addresses 012 to 020 can be used to read the current date and time value. The following is an overview of how to read these values.

Address	Length	Description	Value Range	Attribute
012	1	Year	0 ~ 9999	R
013	1	Month	1 ~ 12	R
014	1	Day	1 ~ 31	R
015	1	Abbreviated day of the week: SUN, MON, TUE, WED, THU, FRI, SAT	0 ~ 6	R
016	1	Day of the week: Sunday, Monday, Tuesday, Wednesday, Thursday, Friday, Saturday	0 ~ 6	R
017	1	Day of the week in Chinese characters: 日、一、二、三、四、五、六	0 ~ 6	R
018	1	Hours (24-hour format)	0 ~ 23	R
019	1	Minutes	0 ~ 59	R
020	1	Seconds	0 ~ 59	R

For example, the following explains how to configure a message to display the current date for the iKAN series device in message 1:

1. Select the message **No. 1**, and then click the  button

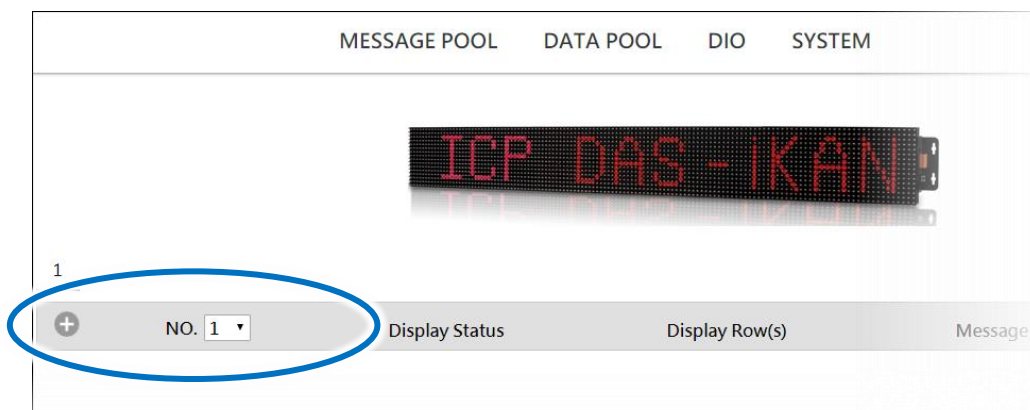

2. Click the  button

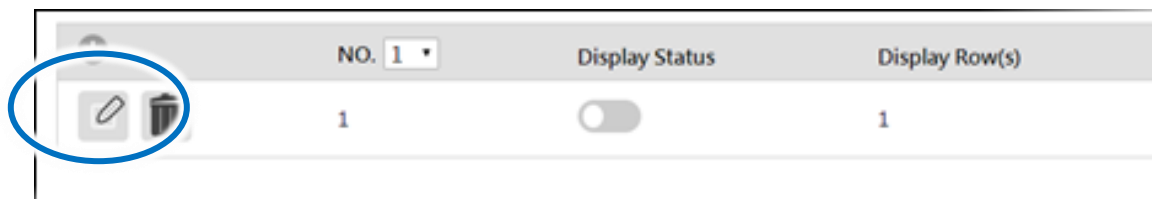

3. In the **No. 1** form, specify the following parameters:

- i. Check the **Display Status** checkbox
- ii. Select the desired color from the **Color** drop-down menu
- iii. Enter the following string in the **Message** text field:  
    %y012/%y013/%y014 %y018 : %y019
- iv. Click the **Update** button

NO. 1

Display Status  Instant

Message Moving Mode

Row(s)

Color

Message

The IP address for the iKAN series device will be shown on the display.





### 4.2.3.3. Displaying the CO2 and Temperature Values from a Remote DL-302 Module

Addresses 021 to 026 can be used to read data from a remote DL-302 module. The following is an overview of how to read these values.

Address	Length	Description	Value Range	Attribute
021	1	DL series module name (low word)	0x0301~0x0302	R
022	1	DL series module name (high word)	0x444C	R
023 : 029	7	Refer to DL series Modbus Address 30001~30007 or 40001~40007		R

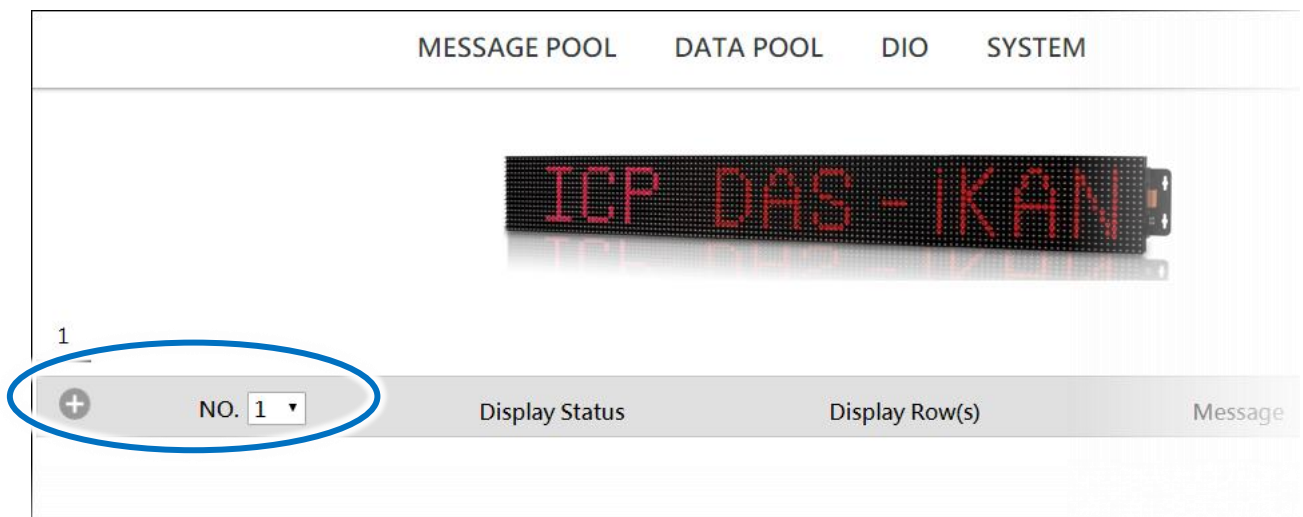

For example, the following explains how to configure a message to display the CO2 and temperature data from a remote DL-302 module on the iKAN series device using message 1:

1. Select the message **No. 1**, and then click the  button

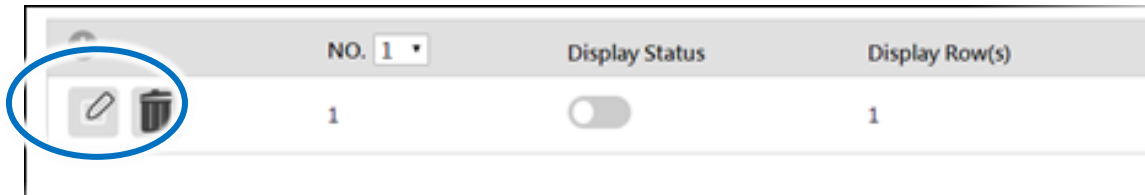

2. Click the  button



	NO. 1 ▾	Display Status	Display Row(s)
 	1	<input type="checkbox"/>	1

3. In the **No. 1** form, specify the following parameters:

- i. Check the **Display Status** checkbox
- ii. Select the desired color from the **Color** drop-down menu
- iii. Enter the following string in the **Message** text field:  
CO2: %y021 PPM, Temp: %y023
- iv. Click the **Update** button

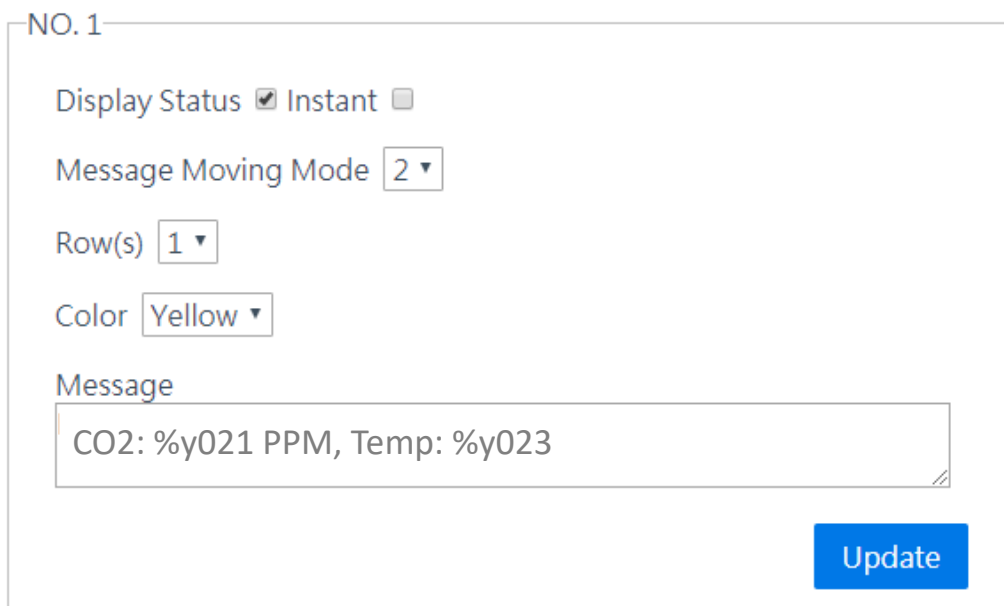

NO. 1

Display Status  Instant

Message Moving Mode  ▾

Row(s)  ▾

Color  ▾

Message

The IP address for the iKAN series device will be shown on the display.

**CO2: 702 PPM, Temp: 25 °C**



## 4.2.4. Inserting Integer-type Variables into a Message

iKAN display devices provide Modbus registers for 64 integer variables, allowing the Host PC or a PLC to read or write data via the Modbus TCP/ RTU protocol. These values can also be inserted into a message. If these inserted values are modified via a remote Host or a PLC, the value will be automatically refreshed when it is displayed on the iKAN series device.

The format for using a variable in a message is a 5-byte string as follows:

1	2	3 to 5		
Delimiter Character	Variable Type	Address: 3-digit decimal number		
%	u: Unsigned integer (0~65535)	X	X	X
	i: Signed integer (-32768~32767)			

A maximum of 64 integer variables can be stored on the iKAN series device, and are accessed using addresses 000 to 063.

Address	Length	Description	Value Range	Attribute
000 : 063	64	Integer-type variables	0 ~ 65535	R/W

For example, the following explains how to insert a signed type integer variable into Modbus register 40001 using message address 1.

1. Select the message **No. 1**, and then click the  button

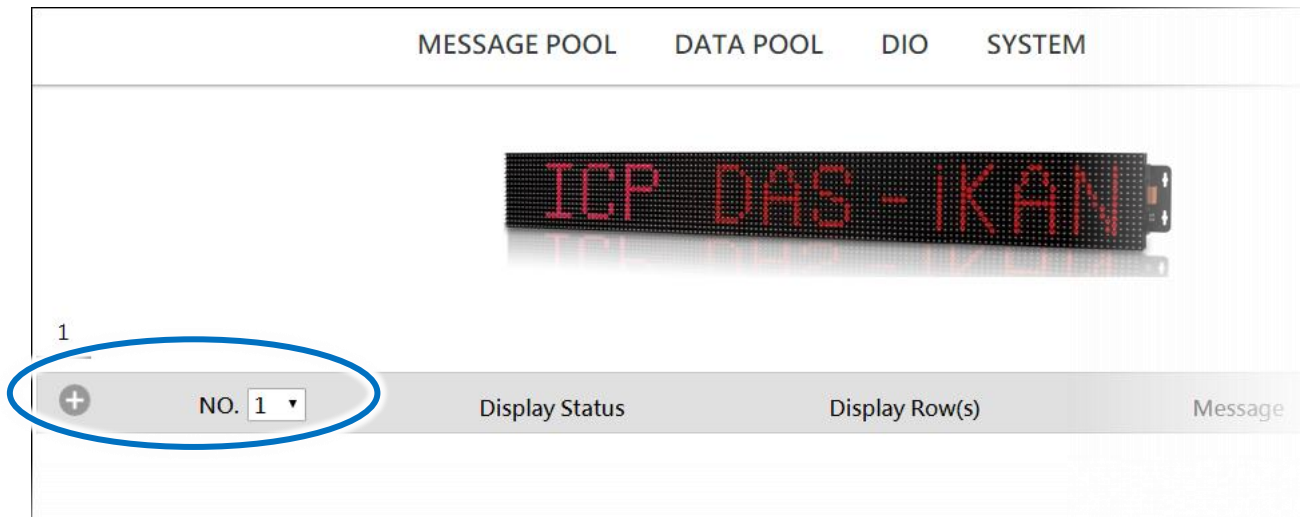

2. Click the  button

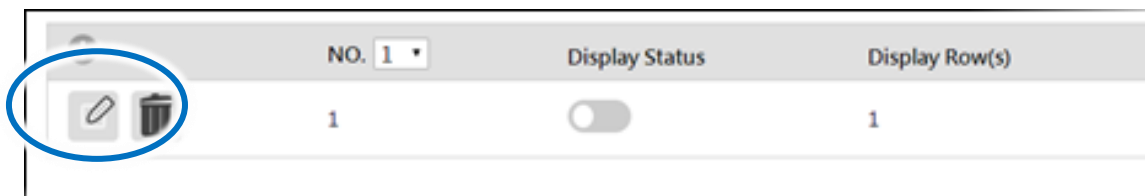

3. In the **No. 1** form, specify the following parameters:
- i. Check the **Display Status** checkbox
  - ii. Select the desired color from the **Color** drop-down menu
  - iii. Enter the following string in the **Message** text field:  
Input Voltage: %i001 V
  - iv. Click the **Update** button

NO. 1

Display Status  Instant

Message Moving Mode

Row(s)

Color

Message

The value for integer variable 1 will be shown on the iKAN display.

**Input Voltage: 32767 V**

iKAN series devices provide the data mapping function for Integer-type variables, please refer to section “4.3.1. Displaying the Mapping Data for Integer-type Variables” for more details.

## 4.2.5. Inserting float-type Variables into a Message

iKAN display devices provide Modbus registers for 60 float variables, allowing the Host PC or a PLC to read or write data via the Modbus TCP/ RTU protocol. These values can also be inserted into a message. If these inserted values are modified via a remote Host or a PLC, the value will be automatically refreshed when it is displayed on the iKAN series device.

The format for using a variable in a message is a 5-byte string as follows:

1	2	3 to 5		
Delimiter Character	Variable Type	Address: 3-digit decimal number		
%	f: Float variable (-3.4E+38 ~ +3.4E+38)	X	X	X

A maximum of 64 float variables can be stored on the iKAN series device, and are accessed using addresses 128 to 246.

Address	Length	Description	Value Range	Attribute
128 : 246	60	Float-type variables	3.4E+38 ~ +3.4E+38	R/W

For example, the following explains how to insert a float-type variable into Modbus register 40130 using message address 1.

1. Select the message **No. 1**, and then click the  button

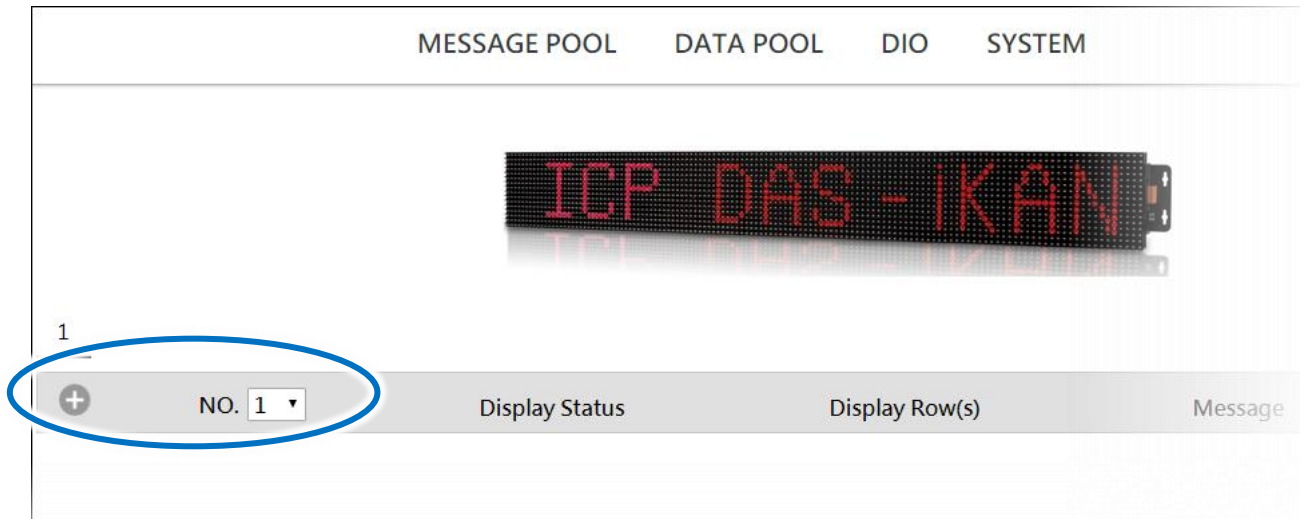

2. Click the  button

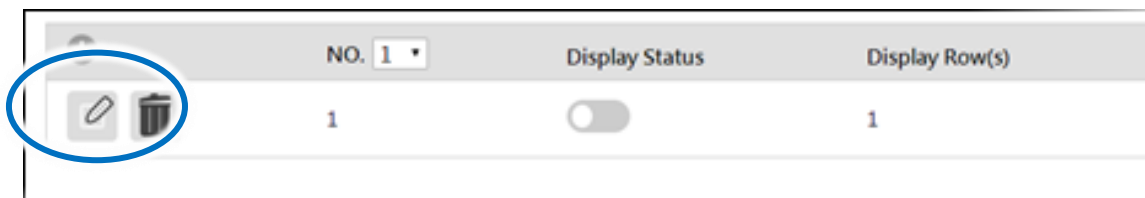

3. In the **No. 1** form, specify the following parameters:

- i. Check the **Display Status** checkbox
- ii. Select the desired color from the **Color** drop-down menu
- iii. Enter the following string in the **Message** text field:  
Pressure: %f130 bars
- iv. Click the **Update** button

NO. 1

Display Status  Instant

Message Moving Mode

Row(s)

Color

Message

The value for float-type variable 1 will be shown on the iKAN display.

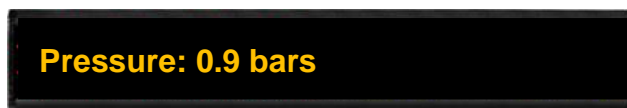

iKAN series devices allow the number of decimal places increased for Float-type variables, please refer to section “4.3.2. Displaying the Number with Increased Decimal Places for Float-Type Variables” for more details.

## 4.2.6. Inserting Coil –type Variables into a Message

iKAN display devices provide Modbus registers for 40 coil variables, allowing the Host PC or a PLC to read or write data via the Modbus TCP/ RTU protocol. These values can also be inserted into a message. If these inserted values are modified via a remote Host or a PLC, the value will be automatically refreshed when it is displayed on the iKAN series device.

The format for using a variable in a message is a 5-byte string as follows:

1	2	3 to 5		
Delimiter Character	Variable Type	Address: 3-digit decimal number		
%	b: Coil	X	X	X

A maximum of 40 Coil type variables can be stored on the iKAN series device, and are accessed using addresses 000 to 039.

Address	Length	Description	Value Range	Attribute
000 : 039	40	Coil-type variables	-	R/W

For example, the following explains how to insert a coil variable into Modbus register 00000 using message 1:

1. Select the message **No. 1**, and then click the  button

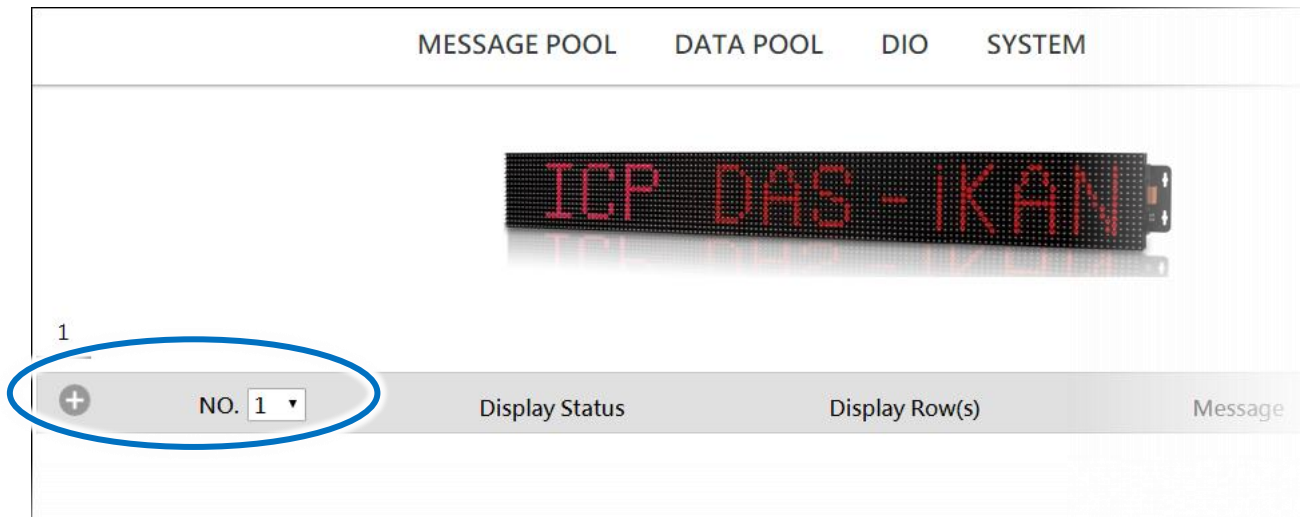

2. Click the  button

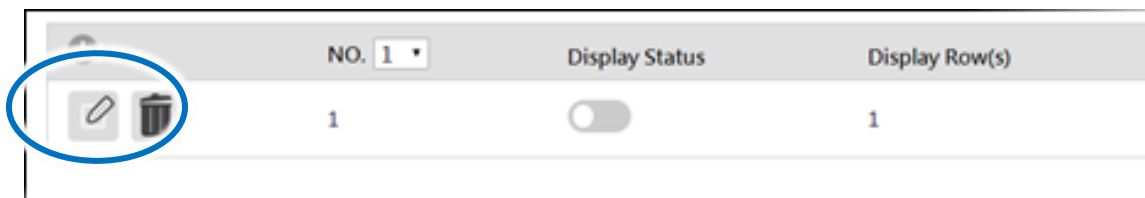



3. In the **No. 1** form, specify the following parameters:
- i. Check the **Display Status** checkbox
  - ii. Select the desired color from the **Color** drop-down menu
  - iii. Enter the following string in the **Message** text field:  
Coil variable 0 = %b001
  - iv. Click the **Update** button

NO. 1

Display Status  Instant

Message Moving Mode

Row(s)

Color

Message

The value for Coil variable 1 will be shown on the iKAN display.

**Coil variable 0 = 1**

iKAN series devices provide a string mapping function that allows the value of the coil variable to be mapped, please refer section “4.3.3. Displaying the Value of a Coil with the Replacement Text” for more details.

## 4.2.7. Inserting ASCII Strings into a Message

iKAN display devices provide Modbus registers for 8 ASCII strings, allowing the Host PC or a PLC to read or write data via the Modbus TCP/ RTU protocol. These values can also be inserted into a message. If these inserted values are modified via a remote Host or a PLC, the value will be automatically refreshed when it is displayed on the iKAN series device.

The format for using a variable in a message is a 5-byte string as follows:

1	2	3 to 5		
Delimiter Character	Variable Type	Modbus Address: 3-digit decimal number		
%	a: ASCII string	X	X	X

A maximum of 64 float variables can be stored on the iKAN series device, and are accessed using Modbus register addresses 40000 to 40063.

Modbus Address		Length	Description	Value Range	Attribute
Decimal	Hex.				
41800 :	0708 :	32	ASCII string 0 contents	ASCII	R/W
41831	0727				
41832 :	0728 :	32	ASCII string 1 contents	ASCII	R/W
41863	0747				
41864 :	0748 :	32	ASCII string 2 contents	ASCII	R/W
41895	0767				
41896 :	0768 :	32	ASCII string 3 contents	ASCII	R/W
41927	0787				



41928 : 41959	0788 : 07A7	32	ASCII string 4 contents	ASCII	R/W
41960 : 41991	07A8 : 07C7	32	ASCII string 5 contents	ASCII	R/W
41992 : 42023	07C8 : 07E7	32	ASCII string 6 contents	ASCII	R/W
42024 : 42055	07E8 : 0808	32	ASCII string 7 contents	ASCII	R/W

For example, the following explains how to configure a message to display the current date for the iKAN series device in the message at address 1:

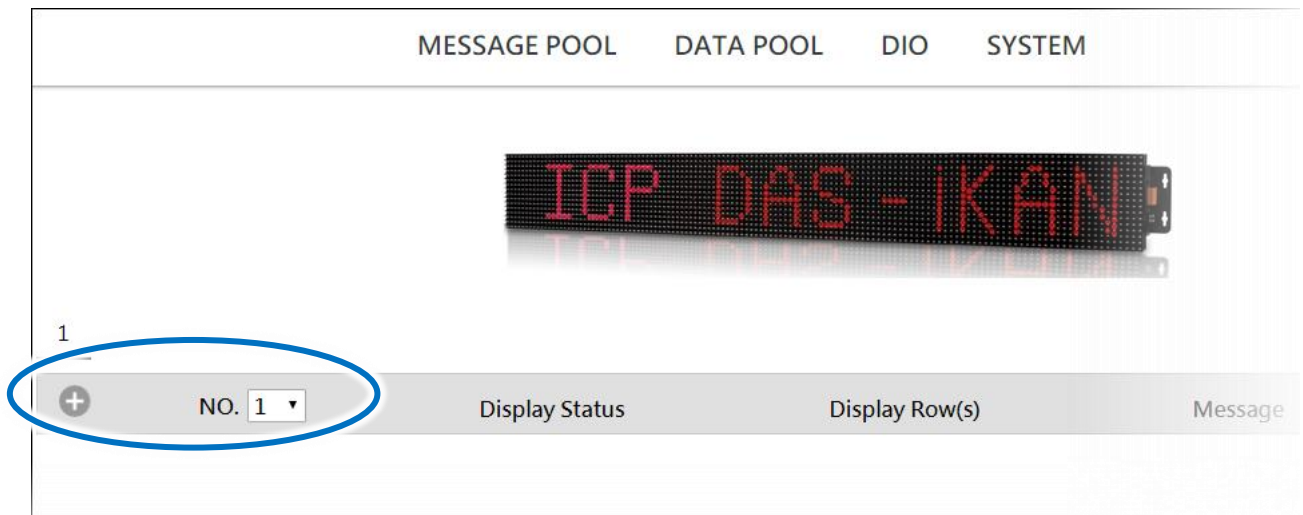
1. Select the message **No. 1**, and then click the  button



2. Click the  button

	NO. 1 ▾	Display Status	Display Row(s)
 	1	<input type="checkbox"/>	1

3. In the **No. 1** form, specify the following parameters:

- i. Check the **Display Status** checkbox
- ii. Select the desired color from the **Color** drop-down menu
- iii. Enter the following string in the **Message** text field:  
%a0
- iv. Click the **Update** button

NO. 1

Display Status  Instant

Message Moving Mode  ▾

Row(s)  ▾

Color  ▾

Message

The stored value for ASCII string 0 will be shown on the iKAN display.

**ASCII string!**

## 5. Writing Variables and DI, DO

## 5.1. Coil-type Variables

### 5.1.1. Modify the value of Coil-type variables through PROFIBUS master

1. Click the **PROFIBUS** menu, and select “Coil Variables” which Coil Variables you want to modify, and press update button. We select Coil variables 0~15 in this example.

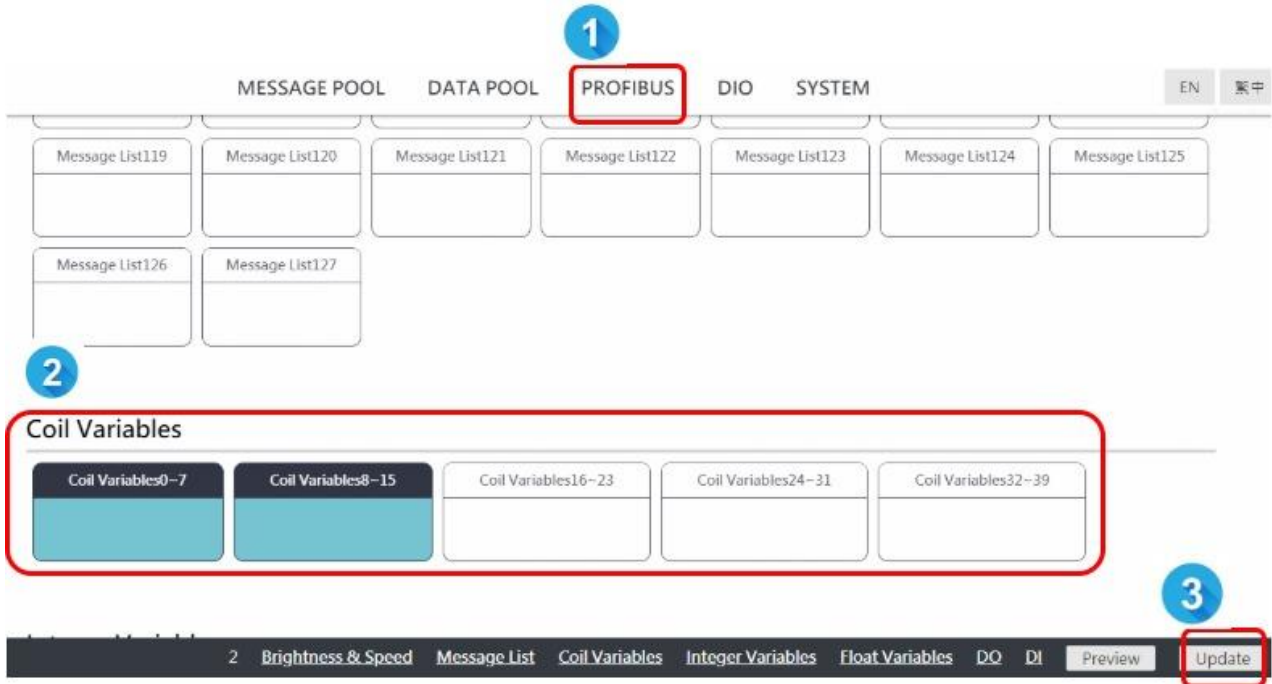

- 1 Click "PROFIBUS" menu
- 2 Select Coil Variables 0~7 and Coil Variables 8~15
- 3 Press "Update" button

2. Enter the value in PROFIBUS master, you can see the value of Coil variables are changed in the data pool.

The screenshot shows a control system interface with a table of coil variables and a digital display. A red box highlights the 'Modify value' column in the table, and a red arrow points from it to a 'COIL' tab in the interface. Below the tab is a table of coil variables with values 0 or 1.

Address	Symbol	Display format	Status value	Modify value
QB 20		HEX	B#16#7A	B#16#7A
QB 21		HEX	B#16#63	B#16#63
QB 22		HEX	B#16#00	B#16#00
QB 23		HEX	B#16#00	B#16#00

MESSAGE POOL DATA POOL PROFIBUS DIO SYSTEM EN

ICP DAS - IKAN

INTEGER FLOAT COIL

Coil Variables							
0	1	2	3	4	5	6	7
0	1	0	1	1	1	1	0
8	9	10	11	12	13	14	15
1	1	0	0	0	1	1	0

- 1 | The value of Coil Variables in PROFIBUS master  
Coil Variables 0~7 :0x7A  
Coil Variables 8~15:0x63

---

- 2 | The value of Coil Variables in IKAN-PFB webpage



3. You can check the value of Coil Variables on the web interface.

1

MESSAGE POOL **DATA POOL** PROFIBUS DIO SYSTEM EN

3    INTEGER   FLOAT   **COIL** 2

**Coil Variables**

0	1	2	3	4	5	6	7
0	1	0	1	1	1	1	0
8	9	10	11	12	13	14	15
1	1	0	0	0	1	1	0

4. Data analysis in the example

item	Coil variables 0~7							
Bit position	7	6	5	4	3	2	1	0
Value (BIN)	0	1	1	1	1	0	1	0
Value (HEX)	7				A			

item	Coil variables 8~15							
Bit position	7	6	5	4	3	2	1	0
Value (BIN)	0	1	1	0	0	0	1	1
Value (HEX)	6				3			

## 5.1.2. Displaying the Value of a Coil Variable with the Replacement Text

The contents of a coil variable can be either 0 or 1, which is usually used to indicate the status of the Digital Output, i.e., ON or OFF.

Click the address number of the coil variable which you would like to configure. The configuration area has been registered according to the selected address number.

The screenshot shows a configuration interface with the following elements:

- Navigation tabs: MESSAGE POOL, DATA POOL, DIO, SYSTEM.
- Variable type tabs: INTEGER, FLOW, COIL (selected and circled in blue).
- Coil Variables grid (addresses 0-39):

0	1	2	3	4	5	6	7
0	0	0	0	0	0	0	0
8	9	10	11	12	13	14	15
0	0	0	0	0	0	0	0
16	17	18	19	20	21	22	23
0	0	0	0	0	0	0	0
24	25	26	27	28	29	30	31
0	0	0	0	0	0	0	0
32	33	34	35	36	37	38	39
0	0	0	0	0	0	0	0
- Configuration area (dashed border):
  - Address: 1
  - Value: 0
  - Color: Red
  - Buttons: Update, Adv. Config, Cancel

iKAN series devices provide a string mapping function that allows the value of the coil variable to be mapped in order to make the coil value more meaningful when reading the message. The text mapping function allows a maximum of 10 Unicode characters or 30 ASCII characters to be entered to represent a value of 0 or 1.

For example, the following explains how to configure the text mapping for the Coil variable at address 1. This example is a continuation of the example in section 4.2.4.

1. Click the address 1 option, and then click the **Adv. Config** button

MESSAGE POOL		DATA POOL		DIO		SYSTEM	
INTEGER	FLOAT	COIL					
<b>Coil Variables</b>							
0	1	2	3	4	5	6	7
0	0	0	0	0	0	0	0
8	9	10	11	12	13	14	15
0	0	0	0	0	0	0	0
16	17	18	19	20	21	22	23
0	0	0	0	0	0	0	0
24	25	26	27	28	29	30	31
0	0	0	0	0	0	0	0
32	33	34	35	36	37	38	39
0	0	0	0	0	0	0	0
1	0	Red	Update	Adv. Config	Cancel		

2. Enter the following mapping text, and then click the **Update** button

- i. In the ON Text column, enter the mapping text in the text field for when the status of the coil-type variable is set to ON status.
- ii. In the OFF Text column, enter the mapping text in the text field for when the status of the coil-type variable is set to OFF status.

No.	ON Text	OFF Text	Update	Cancel
1	Operating	Stop	Update	Cancel

The value for coil variable 1 is now replaced by the mapping text on the display.

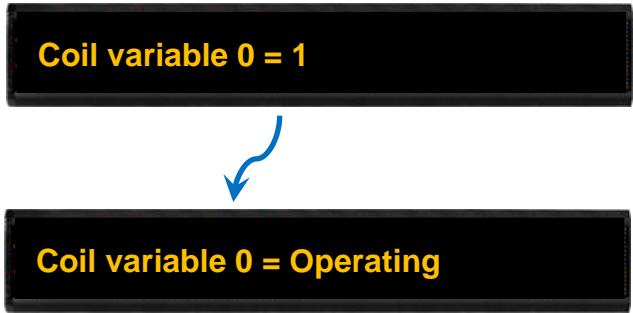

## 5.2. Integer-type Variables

## 5.2.1. Modify the value of Integer-type variables through PROFIBUS master

1. Click the **PROFIBUS** menu, and select “Integer-type variables” which Integer-type variables you want to modify, and press update button. We select “Integer-type variables 0” and “Integer-type variables1” in this example.

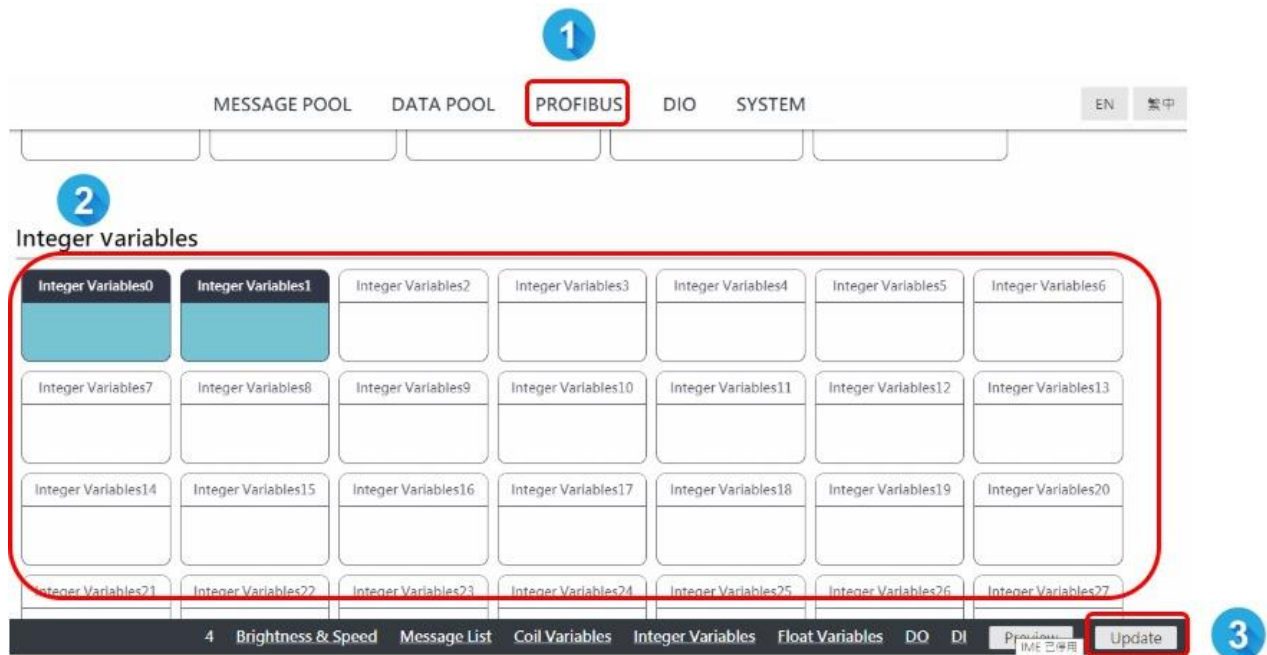

- 1 Click "PROFIBUS" menu
- 2 Select "Integer Variables 0" and "Integer Variables 1"
- 3 Press "Update" button



## 5.2.2. Displaying the Mapping Data for Integer-type Variables

Most industrial measuring devices use 16-bit integers to convert a value from a data source to a real physical value, such as the voltage, temperature, or relative humidity, etc. For example, using the range -32768 to 36767 to convert to -10V to +10V. The iKAN series device is able to perform data mapping to translate an integer value that has been read from a remote data source to a readable physical value.

For example, the following explains how to configure the data mapping function for an integer-type variable at address 1.

This example is a continuation of the example in section 4.2.2.

1. Click the address **1** option, and then click the **Adv. Config** button

The screenshot shows a configuration interface with the following elements:

- Navigation tabs: MESSAGE POOL, DATA POOL, DIO, SYSTEM
- Variable type selection: INTEGER, FLOAT, COIL
- Section: Integer Variables
- Dropdown menu: signed
- Display button
- Grid of variables (0-22) with values (0-0)
- Selected variable: 1
- Configuration fields: 1, 0, Red, Update, Adv. Config

0	1	2	3	4	5	6
0	0	0	0	0	0	0
8	9	10	11	12	13	14
0	0	0	0	0	0	0
16	17	18	19	20	21	22
0	0	0	0	0	0	0

Configuration fields: 1, 0, Red, Update, Adv. Config



## 2. Considering the arguments for data mapping

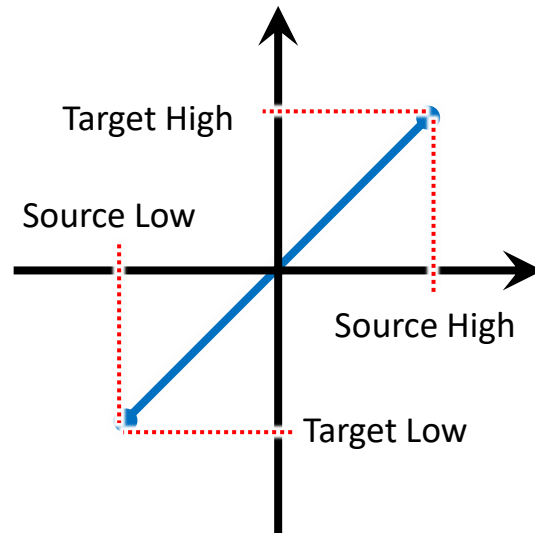

For example, to convert a 16-bit unsigned integer (0 to 65535) to the voltage 0 to 10 V, set the following arguments:

Argument	Value	Description
Source Low	0	The minimum value of the integer
Target Low	0	The minimum value of the physical value
Source High	65535	The maximum value of the integer
Target High	10	The maximum value of the physical value
Decimal Places	-	The number of decimal places to be used for the converted value

3. Enter the following value, and then click the **Update** button

- i. In the **Source Low** column, enter the minimum value of the integer value.
- ii. In the **Source High** column, enter the maximum value of the integer value.
- iii. In the **Target Low** column, enter the minimum value of the physical value.
- iv. In the **Target High** column, enter the maximum value of the physical value.
- v. From the **Decimal Places** column, select the desired number of decimal places to be used for the converted value.

No.	Source Low	Source High	Target Low	Target High	Decimal Places	Update
1	<input type="text" value="0"/>	<input type="text" value="65535"/>	<input type="text" value="0"/>	<input type="text" value="10"/>	<input type="text" value="2"/>	<input type="button" value="Update"/>

The value for integer variable 1 will be shown on the iKAN display, but will now use the scaled value text rather than the integer value.

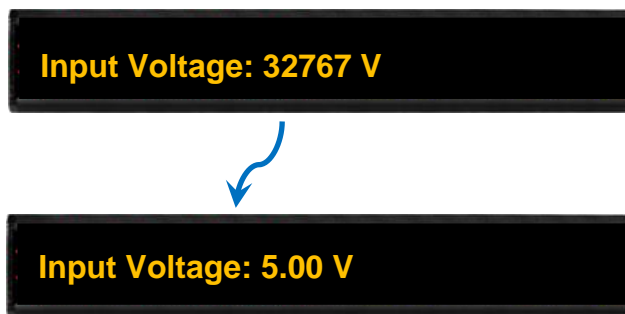

## 5.3. Float-type Variables

### 5.3.1. Modify the value of Float-type variables through PROFIBUS master

1. Click the **PROFIBUS** menu, and select “Float-type variables” which Float-type variables you want to modify, and press update button. We select “Float-type variables 0” and “Float-type variables1” in this example.

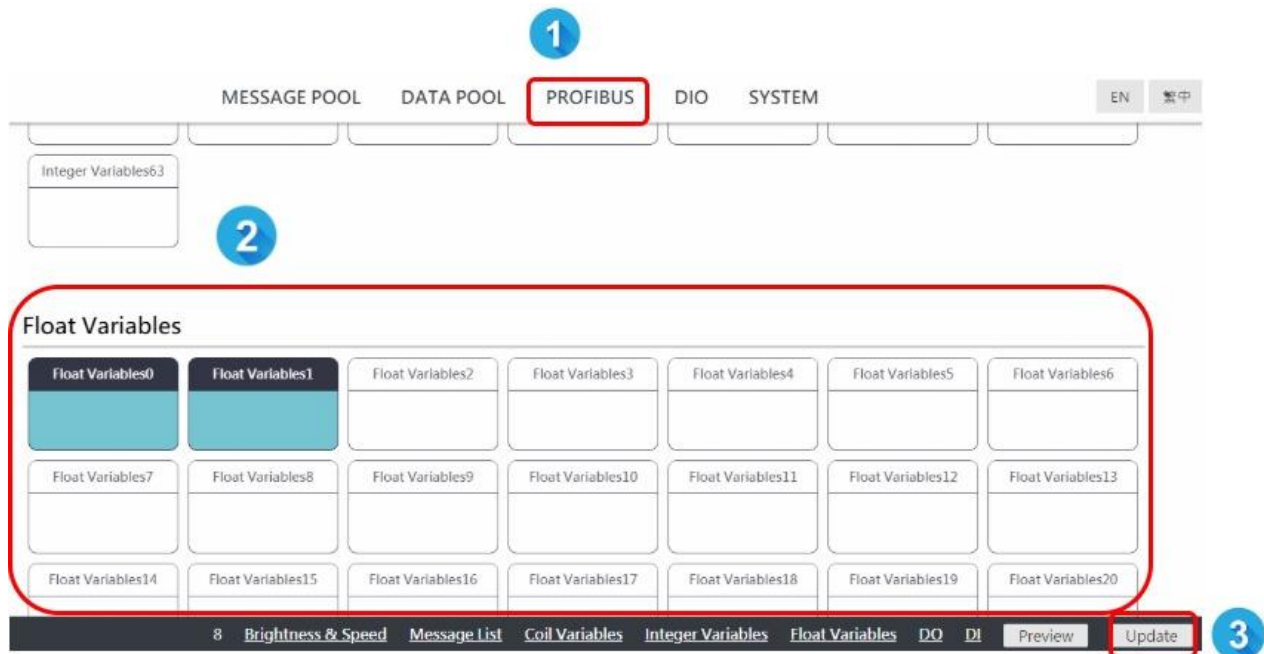

- 1 | Click "PROFIBUS" menu
- 2 | Select Float Variables 0 and Float Variables 1
- 3 | Press "Update" button

2. Enter the value in PROFIBUS master, you can see the value of Float-type variables are changed in the data pool.

The screenshot shows two parts of the PROFIBUS master interface. On the left, a table labeled '1' shows data points:

Address	Symbol	Display format	Status value	Modify value
QD 20		HEX	DW#16#3F7B22D1	DW#16#3F7B22D1
QD 24		HEX	DW#16#42F6CCCC	DW#16#42F6CCCC

On the right, a panel labeled '2' shows 'Float Variables' with two columns:

0	2
0.981	123.4

Red boxes and arrows highlight the connection between the hex values in the table and the float values in the variables panel.

- |          |  |
|----------|--|
| <b>1</b> | The value of Float Variables in PROFIBUS master:<br>Float Variables_0 : 0x3F7B22D1<br>Float Variables_1 : 0x42F6CCCC |
| <b>2</b> | The value of Float Variables in the webpage:<br>Float Variables_0 : 0.981<br>Float Variables_1 : 123.4               |

3. You can check the value of Float Variables on the web interface.

The screenshot shows the web interface. At the top, a navigation bar has 'DATA POOL' selected and highlighted with a red box and a '1' in a blue circle. Below the navigation bar is a red LED display showing 'ICP DAS - IKAN'. Below the display, there are tabs for 'INTEGER', 'FLOAT', and 'COIL', with 'FLOAT' selected and highlighted with a red box and a '2' in a blue circle. At the bottom, a panel labeled '3' shows 'Float Variables' with six columns:

0	2	4	6	8	10
0.981	123.4	0.000	0.000	0.000	0.000

Red boxes and arrows highlight the selected 'DATA POOL' and 'FLOAT' tabs, and the float variable values.

### 5.3.2. Displaying the Number with Increased Decimal Places for Float-Type Variables

The number of the decimal places to be used for a float-type variable can be set from the FLOAT VARIABLES page. The offset value is 40128, which means variable 0 is equal to 40128 and variable 2 is equal to 40130, and so on.

For example, the following explains how to set the number of decimal places for float-type variable 40130.

This example is a continuation of the example in section 4.2.3.

1. Click the address **130** option, and then click the **Adv. Config** button

MESSAGE POOL DATA POOL DIO SYSTEM

INTEGER FLOAT COIL

Float Variables

128	130	132	134	136	138
0.0	0.0	0.0	0.0	0.0	0.0
144	146	148	150	152	154
0.0	0.0	0.0	0.0	0.0	0.0
160	162	164	166	168	170
0.0	0.0	0.0	0.0	0.0	0.0

130 0 Red Update Adv. Config

2. From the **Decimal Places** drop-down menu, select the desired number of decimal places to be used, and then click the **Update** button

No. Decimal Places Update

130 1 Update

The value for float-type variable 1 will be shown on the iKAN display using the specified number of decimal places.



## 5.4. DI, DO



## 5.4.1. Wire connection

### DI Wiring

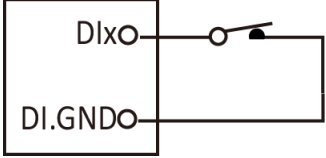
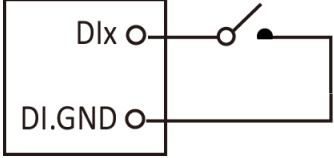
Input Type	On State as 1	OFF State as 0
Dry Contact	Close to GND	Open
		

### DO Wiring

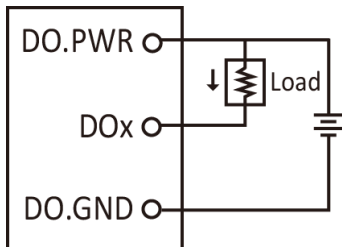
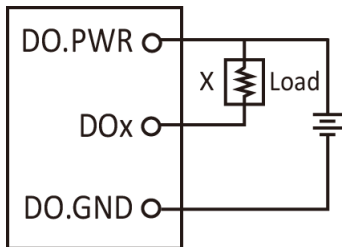
Input Type	On State Readback as 1	OFF State Readback as 0
DO (Sink, NPN)	+5 to +24 VDC	Open
		

## 5.4.2. Read or Write the DI and DO channel through PROFIBUS master

1. Click the **PROFIBUS** menu, and select “DI” or “DO” which DI, DO channel you want to modify or read, and press update button. We select “DI 0~1” and “DO 0~1” in this example.

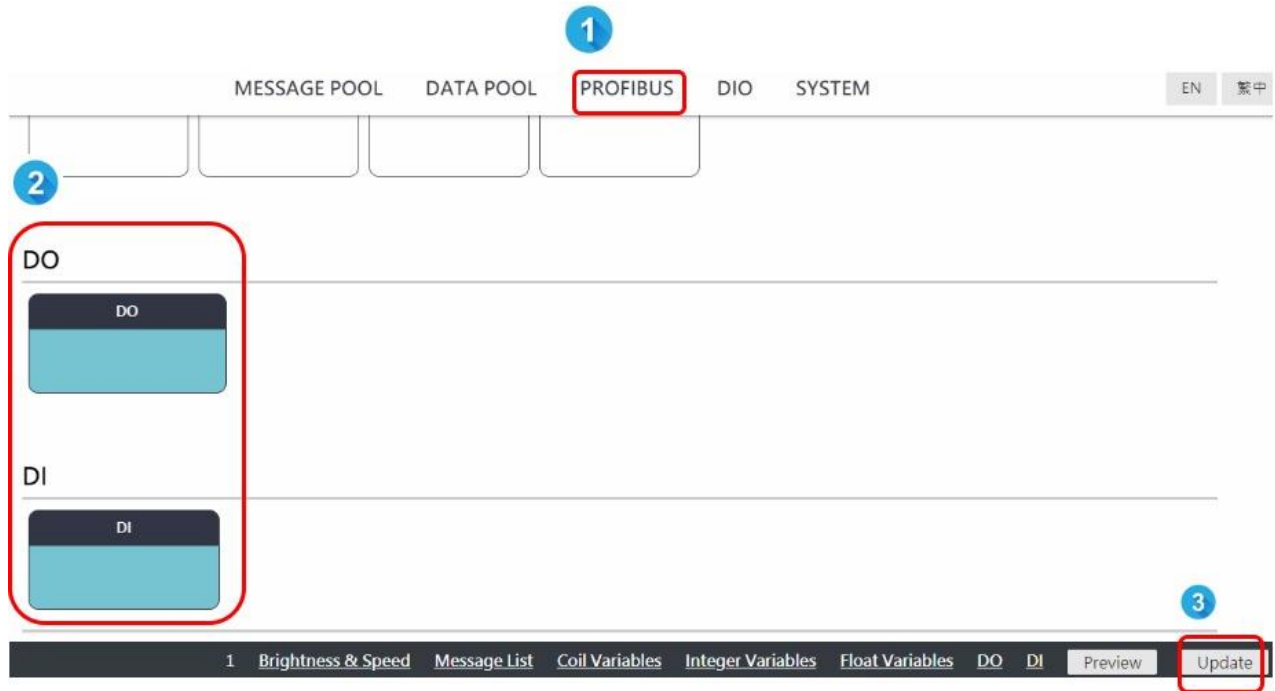

- 1 | Click "PROFIBUS" menu
- 2 | Select DO, DI
- 3 | Press "Update" button

2. Enter DO value 0x02 in PROFIBUS master, you can see the value of DO channel 1 are changed in the **DIO** menu. Close the DI 0 to DI.GND, you can see the value of DI channel 0 are changed in the **DIO** menu and the PROFIBUS master.

Address	Symbol	Display format	Status value	Modify value
QB 20		HEX	B#16#02	B#16#02
IB 36		HEX	B#16#01	

1

DI and DO value in PROFIBUS master:  
Read DI value: 0x01  
Write DO value: 0x02

2

DI and DO value in IKAN-PFB webpage:  
DI: channel 0 on , channel 1 off  
DO: channel 0 off, channel 1 on

2

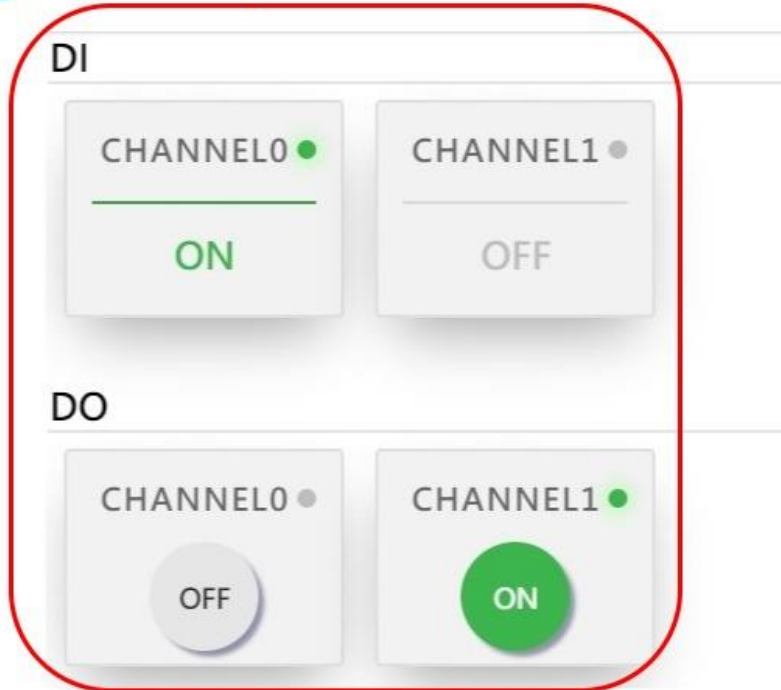

4. You can check the value of DO and DI on the web interface.

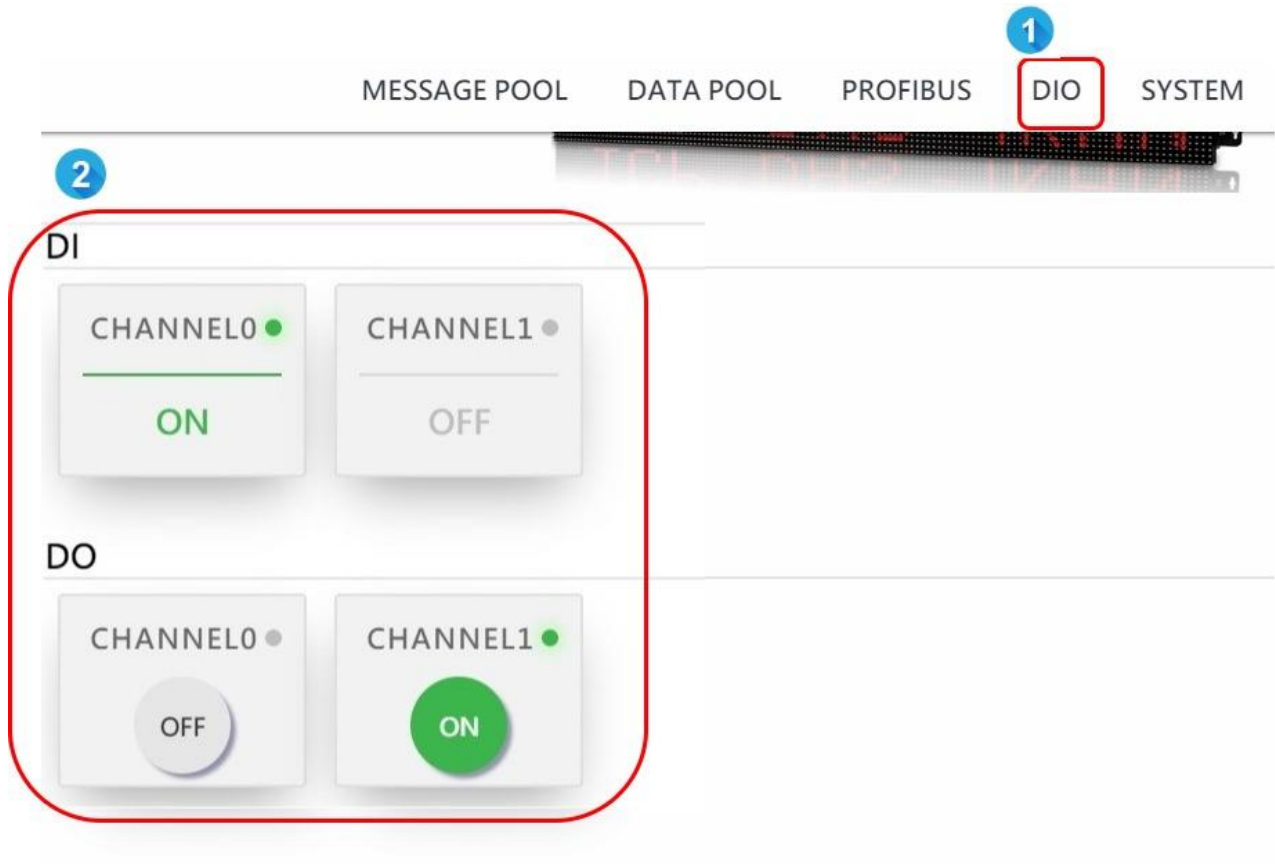

5. Data analysis in the example

item	DO 0~1							
Bit position	7	6	5	4	3	2	1	0
Value (BIN)	0	0	0	0	0	0	1	0
Channel	Reserved						1	0
Value (HEX)	0				2			

Item	DI 0~1							
Bit position	7	6	5	4	3	2	1	0
Value (BIN)	0	0	0	0	0	0	0	1
Channel	Reserved						1	0
Value (HEX)	0				1			

## 6. iKAN Updates

ICP DAS will continue to update the iKAN firmware for more useful functions and better performance. The latest firmware can be obtained from:

<http://ftp.icpdas.com/pub/cd/ikan/firmware/>

The firmware version is listed at the bottom of the MISC.page. You can check the version here to see if the iKAN series device needs a firmware update.

The image shows a screenshot of the iKAN web interface. At the top, there are three tabs: MESSAGE POOL, DATA POOL, and SYSTEM. The SYSTEM tab is highlighted with a blue circle. Below the tabs, there is a navigation menu with options: IMPORT/EXPORT, ETHERNET, SERIAL PORT, and MISC. The MISC. option is highlighted with a blue circle. To the right of the MISC. option, there is a section titled MISC. with a sub-section for Modbus Station ID. The Modbus Station ID is set to 2, and there is an Update button below it. Below the Modbus Station ID section, there is a section for LED Brightness. A blue arrow points from the MISC. option in the navigation menu to the MISC. section. Another blue arrow points from the MISC. section to the Module Information section below.

**Module Information**

Module Name: iKAN-124

Device Firmware Version: 2.1.0

Sub-device Firmware Version: 2.0.0

7188xw Utility is a Win32 console program used to update OS image and firmware. It uses the COM port to communicate with the connected module.

1. Connect the RS-232 port on the iKAN to the RS-232 port on the PC



2. Get the latest version of the iKAN firmware

The latest version of the iKAN firmware can be obtained from:

<http://ftp.icpdas.com/pub/cd/ikan/firmware/>

3. Get the latest version of the 7188xw Utility and extract it

The latest version of the 7188xw Utility can be obtained from:

<http://ftp.icpdas.com/pub/cd/8000cd/napdos/minios7/utility/>

### Tips & Warnings

---



The iKAN firmware and 7188xw utility must be in the same directory.

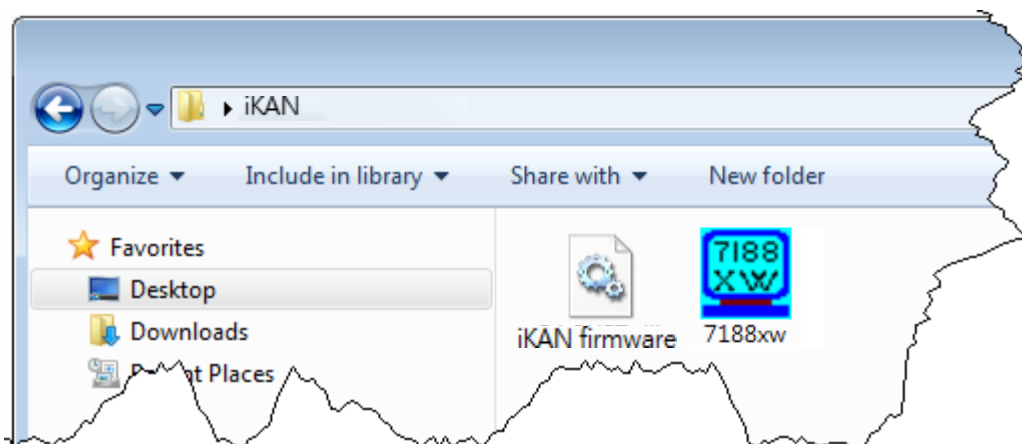

4. Open the command prompt and change the current directory to the directory where the firmware is located
5. Enter command "7188xw /c1 /b115200 /n81" to execute the 7188xw Utility

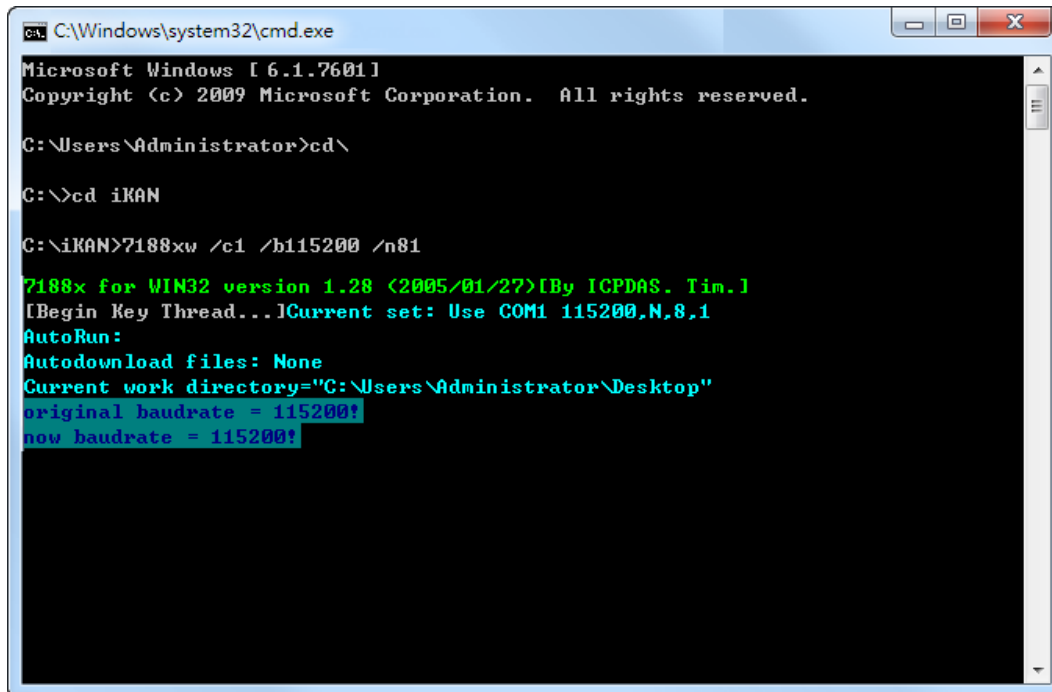

```
C:\Windows\system32\cmd.exe
Microsoft Windows [6.1.7601]
Copyright (c) 2009 Microsoft Corporation. All rights reserved.

C:\Users\Administrator>cd\

C:\>cd iKAN

C:\iKAN>7188xw /c1 /b115200 /n81

7188x for WIN32 version 1.28 <2005/01/27>[By ICPDAS. Tim.]
[Begin Key Thread...!Current set: Use COM1 115200,N,8,1
AutoRun:
Autodownload files: None
Current work directory="C:\Users\Administrator\Desktop"
original baudrate = 115200!
now baudrate = 115200!
```

6. Press the Enter to connect to the iKAN and press the F9 to download the firmware to iKAN

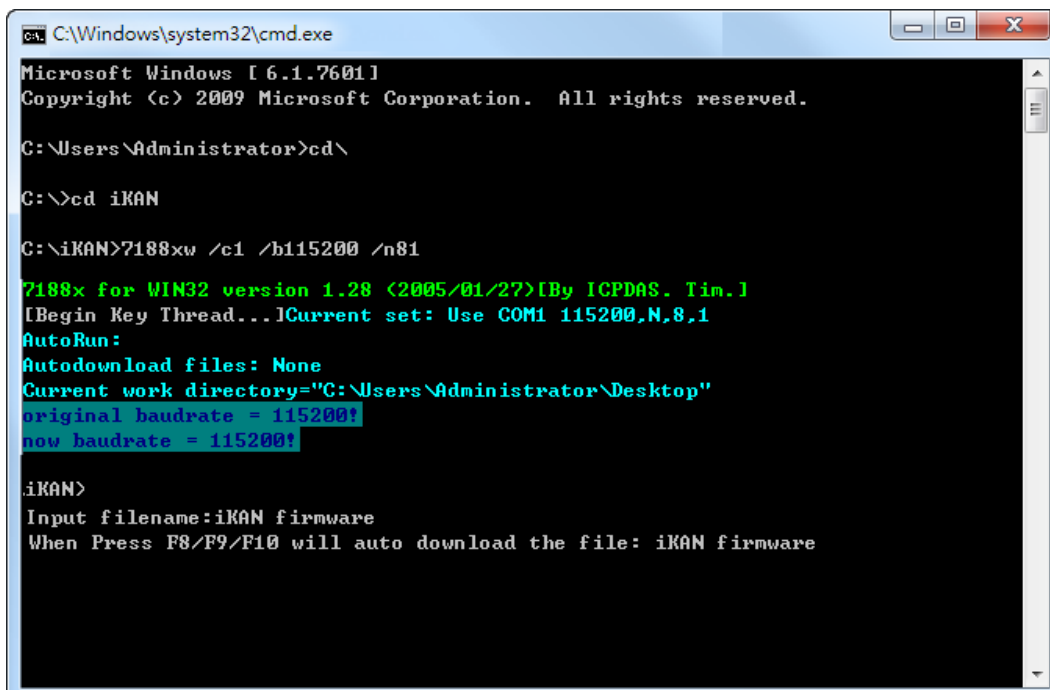

```
C:\Windows\system32\cmd.exe
Microsoft Windows [6.1.7601]
Copyright (c) 2009 Microsoft Corporation. All rights reserved.

C:\Users\Administrator>cd\

C:\>cd iKAN

C:\iKAN>7188xw /c1 /b115200 /n81

7188x for WIN32 version 1.28 <2005/01/27>[By ICPDAS. Tim.]
[Begin Key Thread...!Current set: Use COM1 115200,N,8,1
AutoRun:
Autodownload files: None
Current work directory="C:\Users\Administrator\Desktop"
original baudrate = 115200!
now baudrate = 115200!

iKAN>
Input filename:iKAN firmware
When Press F8/F9/F10 will auto download the file: iKAN firmware
```

7. Wait until all files loading are completed and Reboot the iKAN

# Appendix A. How to –

## A.1. How to set iKAN Display in Modbus Configuration Mode

Before using the Modbus RTU/TCP Command tool, iKAN must be configured in Modbus configuration mode. To configure iKAN into a Modbus configuration mode, follow the instructions given below.

1. Click the **MESSAGE POOL** menu, and then click the **ETHERNET** menu
2. In the COMMON MESSAGES section, specify the following parameters:
  - a. In the Message 0 area, select Display check box, and enter the “WELCOME” in the Message box.
  - b. In the Message 1 area, enter the “%a0” in the Message box.
  - c. In the Message 1 area, enter the “%a0” in the Message box.

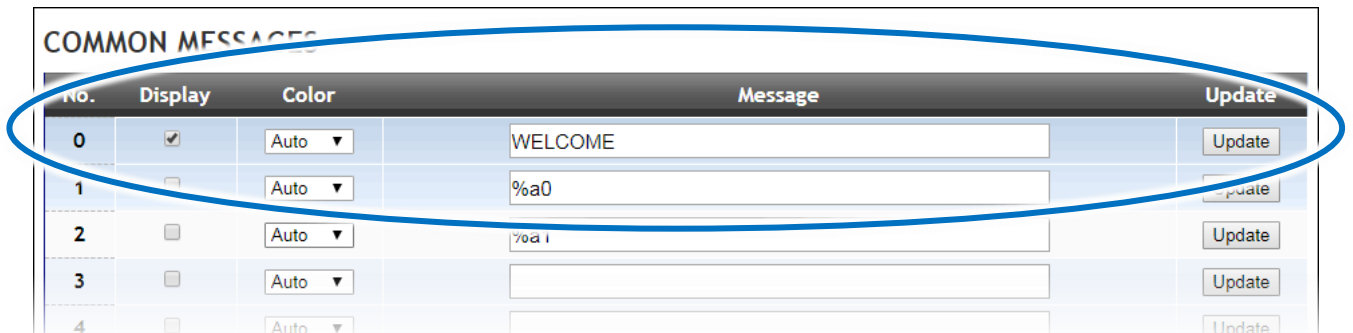

No.	Display	Color	Message	Update
0	<input checked="" type="checkbox"/>	Auto ▼	WELCOME	Update
1	<input type="checkbox"/>	Auto ▼	%a0	Update
2	<input type="checkbox"/>	Auto ▼	%a1	Update
3	<input type="checkbox"/>	Auto ▼		Update
4	<input type="checkbox"/>	Auto ▼		Update

3. The iKAN display will display “WELCOME”. Now the iKAN display is in the Modbus configuration mode, you can start sending Modbus commands to your iKAN display.

For more detailed information on how to use the Modbus RTU/TCP Command tool to communicate with iKAN, please refer to section “**3.2.2. Sending Modbus Command to iKAN**”



## A.2. How to set up the new Project in the PROFIBUS master software. (SIMATIC STEP7 in this example)

1. Double Click "SIMATIC Manager" icon to open "SIMATIC Manager"



2. Open "New Project Wizard"

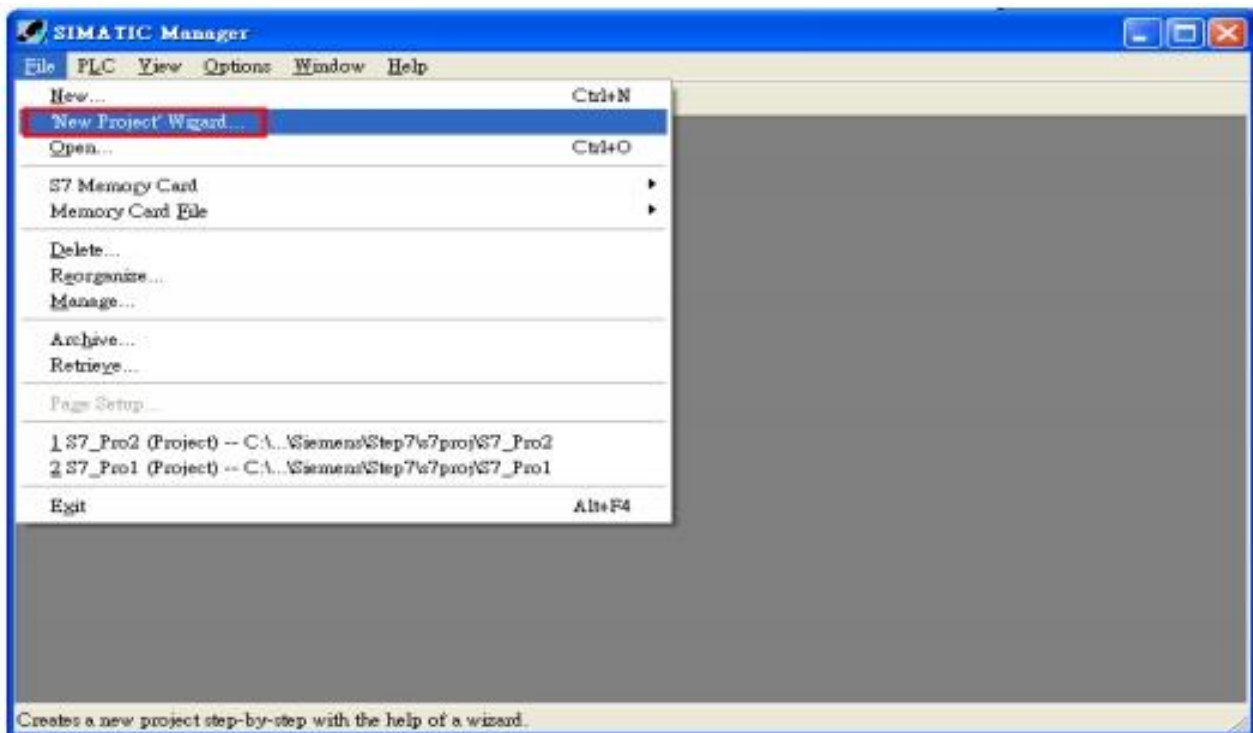

### 3. Set up Project

#### a. Click "Next"



#### b. Select CPU type then click "Next"

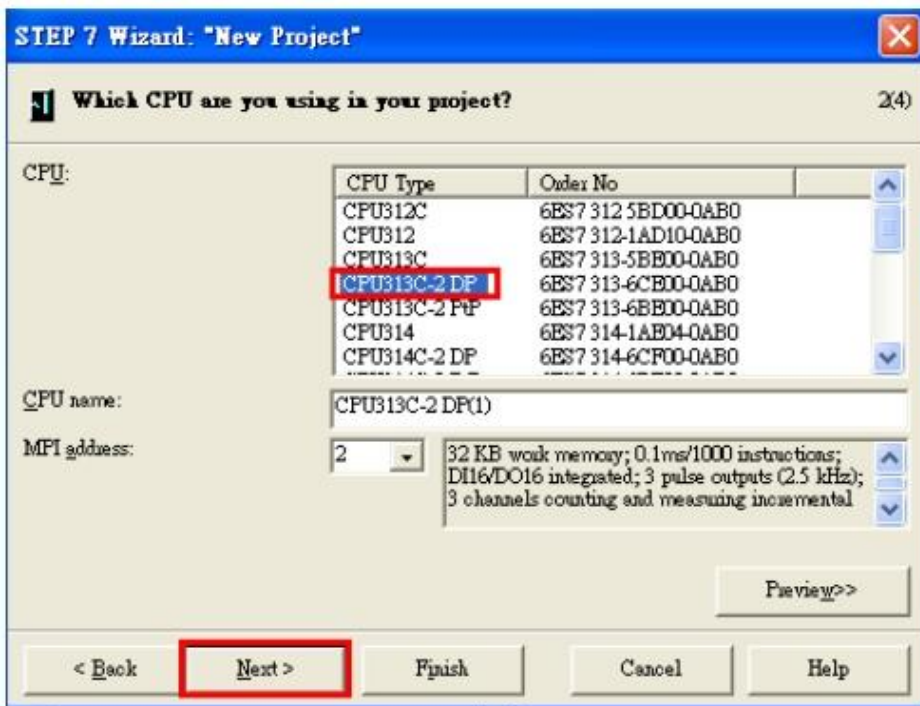

c. Select Blocks and Language for Selected Blocks then click "Next"

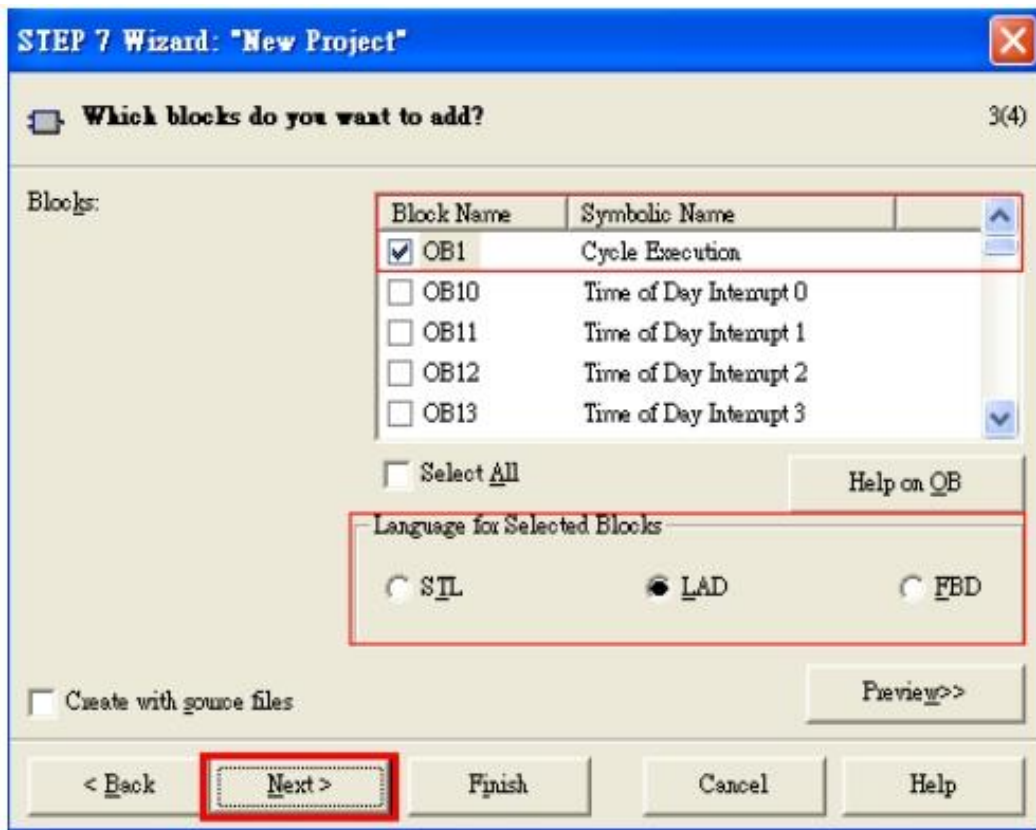

d. Set project name then click "Finish"

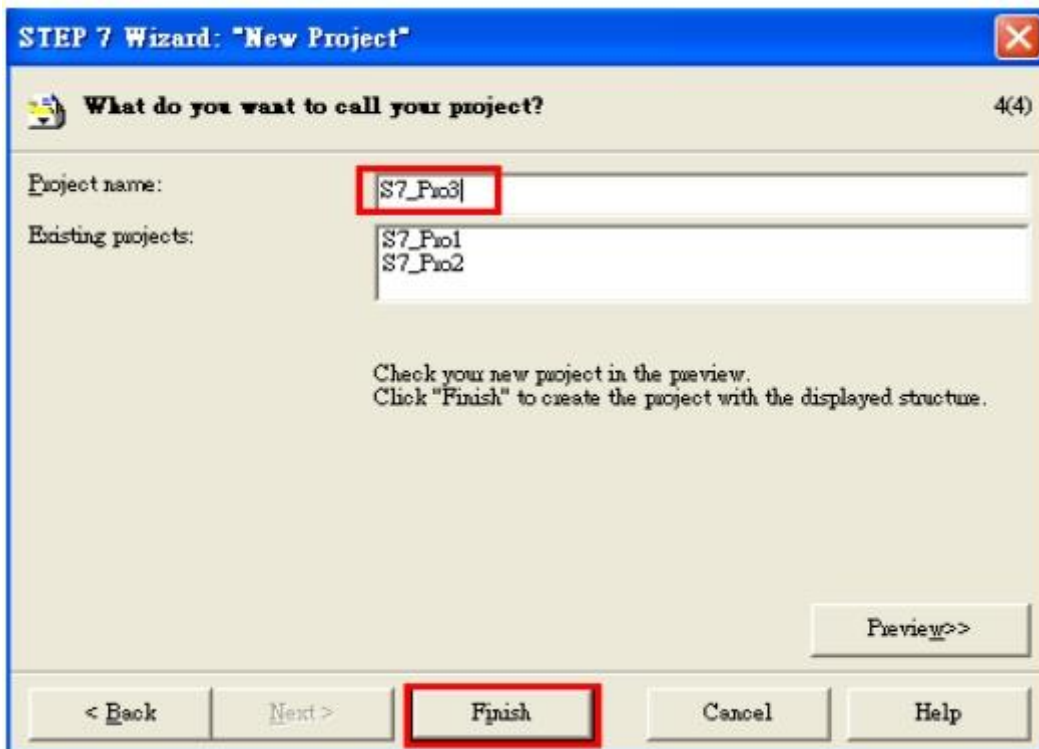

4. Double click “Hardware” to open “HW Config”

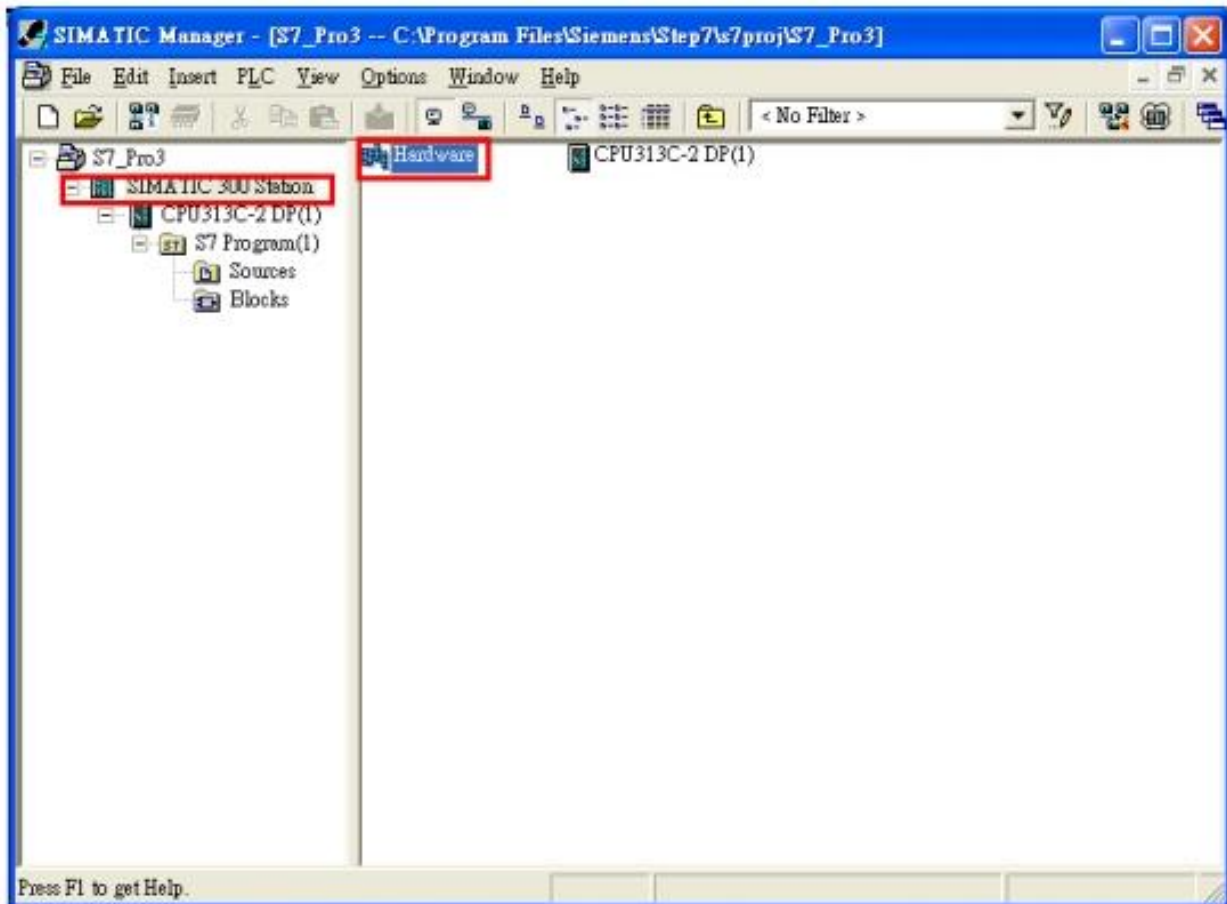

5. You can install the GSD file and configure the IKAN-PFB module and parameters in “HW Config”

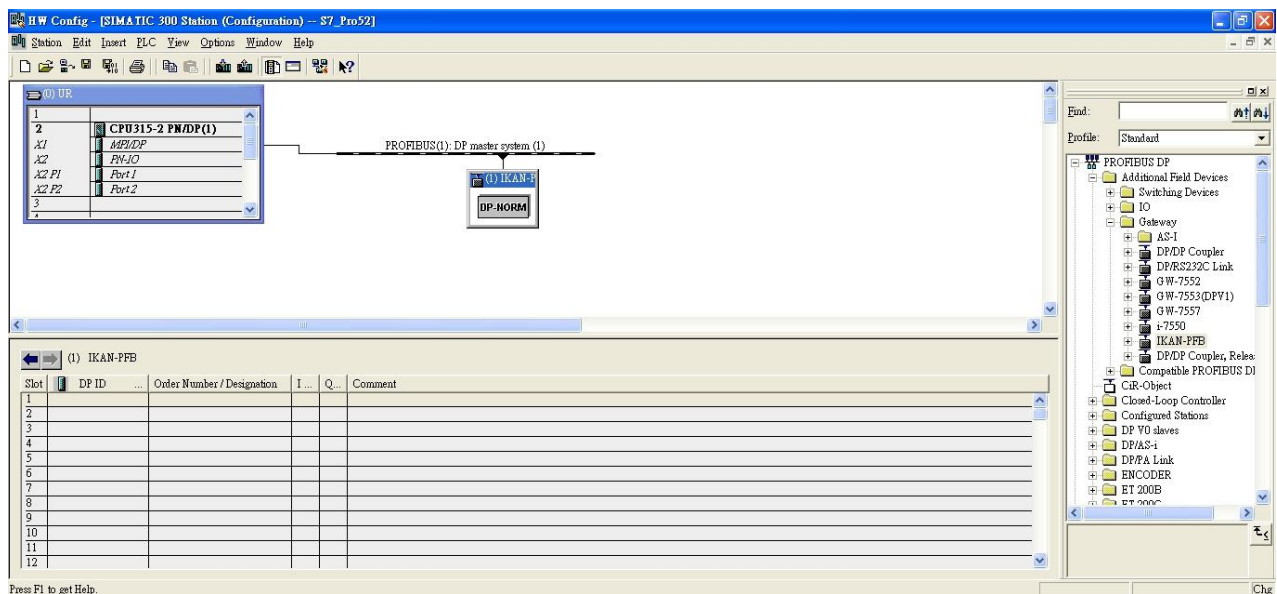

# Appendix B. Variable Types and Modbus Register Map

## B.1. Variable Types

The iKAN series device allows data related to items such as the Ethernet configuration, the RTC value, and other information, to be inserted into a message as a system variable.

The format for using a system variable in a message has a length of 5 bytes as follows:

1	2	3 to 5		
Delimiter Character	Variable Type	Modbus Address: 3-digit decimal number		
%	y: System variable	X	X	X
	b: Coil			
	u: Unsigned integer (0~65535)			
	i: Signed integer (-32768~32767)			
	f: Float (-3.4E+38 ~ +3.4E+38)			

The valid range for each type of variable is:

Variable Type	Range
Coil Variables	%b000 to %b039
Integer Variables	%u000 to %u063
	%i000 to %i063
Float Variables	%f128 to %f254
System Variables	%y000 to %y026

## B.2. Modbus Register Map

### Coil-type variables (0xxxx, 0 based)

Modbus Address		Length	Description	Value Range	Attribute
Decimal	Hex.				
00000 : 00039	0000 : 0027	40	Coil-type variables	-	R/W
00100 : 00227	0064 : 00E3	128	Enables or disables the display of common messages 0 ~ 127.	0: Disabled 1: Enabled	R/W

### System variables (3xxxx, 0 based)

Modbus Address		Length	Description	Value Range	Attribute
Decimal	Hex.				
30000 : 30003	0000 : 0003	4	The IP address for the iKAN series device	0 ~ 255	R
30004 : 30007	0004 : 0007	4	The Mask address for the iKAN series device	0 ~ 255	R
30008 : 30011	0008 : 000B	4	The Gateway address for the iKAN series device	0 ~ 255	R
30012	000C	1	Year	0 ~ 9999	R
30013	000D	1	Month	1 ~ 12	R
30014	000E	1	Day	1 ~ 31	R
30015	000F	1	Abbreviated day of the week: SUN, MON, TUE, WED, THU, FRI, SAT	0 ~ 6	R
30016	0010	1	Day of the week: Sunday, Monday, Tuesday,	0 ~ 6	R

			Wednesday, Thursday, Friday, Saturday		
30017	0011	1	Day of the week in Chinese characters: 日、一、二、三、四、五、六	0 ~ 6	R
30018	0012	1	Hours (24-hour format)	0 ~ 23	R
30019	0013	1	Minutes	0 ~ 59	R
30020	0014	1	Seconds	0 ~ 59	R
30021	0015	1	DL series module name (low word)	0x0301~0x0302	R
30022	0016	1	DL series module name (high word)	0x444C	R
30023 : 30029	0017 : 001D	7	Refer to DL series Modbus Address 30001~30007 or 40001~40007		R

### Integer-type variables/Float-type variables/misc. (4xxxx, 0 based)

Modbus Address		Length	Description	Value Range	Attribute
Decimal	Hex.				
40000 : 40063	0000 : 003F	64	Integer-type variables	0 ~ 65535	R/W
40128 : 40255	0080 : 00FF	64	Float-type variables	3.4E+38 ~ +3.4E+38	R/W
40384 : 40447	0180 : 01BF	64	Data mapping arguments: Source Low	0 ~ 65535	R/W
40512 : :	0200 : :	64	Data mapping arguments: Source High	0 ~ 65535	R/W

40475	023F				
40640 : 40703	0280 : 02BF	64	Data mapping arguments: Target Low	0 ~ 65535	R/W
40768 : 40831	0300 : 033F	64	Data mapping arguments: Target High	0 ~ 65535	R/W
40896 : 40959	0380 : 03BF	64	Data mapping arguments: Decimal Places	0 ~ 2	R/W
41024 : 41087	0400 : 043F	64	Decimal Places for float-type variables	1 ~ 3	R/W
41408 : 41535	0580 : 05FF	128	Color for common messages 0 ~ 127 at first row.	1: Blue 2: Green 3: Sky Blue 4: Red 5: Purple 6: Yellow 7: White 8: Random	R/W
41600	0640	1	Brightness for the display, a smaller number means a brighter screen	0 ~ 4	R/W
41601	0641	1	Message scrolling speed, a smaller number means a higher speed	0 ~ 9	R/W
41602	0642	1	Modbus station ID	1~254	R/W
41604	0644	1	Modbus TCP Slave port	0~65535	R/W
41605	0645	1	Connect to DL-300 series module	0:Disabled 1:Enabled	R/W
41606 : 41609	0646 : 0649	4	The IP address for the DL-300 series device	0 ~ 255	R/W



41610	0650	1	The Modbus TCP port for the DL-300 series device	0~65535	R/W
41611	0651	1	The Modbus TCP ID for the DL-300 series device	1~247	R/W
41612	0652	1	The response timeout value for Modbus TCP communication	0~65535	R/W
41613	0653	1	The Delay between polls value for Modbus TCP communication	0~65535	R/W
41632 : 41759	0660 : 06DF	128	Message priority for messages 0 ~ 127	0: Common 1:Instant	R/W
41800 : 41831	0708 : 0727	32	ASCII string 0 contents	ASCII	R/W
41832 : 41863	0728 : 0747	32	ASCII string 1 contents	ASCII	R/W
41864 : 41895	0748 : 0767	32	ASCII string 2 contents	ASCII	R/W
41896 : 41927	0768 : 0787	32	ASCII string 3 contents	ASCII	R/W
41928 : 41959	0788 : 07A7	32	ASCII string 4 contents	ASCII	R/W
41960 : 41991	07A8 : 07C7	32	ASCII string 5 contents	ASCII	R/W
41992 : 42023	07C8 : 07E7	32	ASCII string 6 contents	ASCII	R/W
42024 : :	07E8 : :	32	ASCII string 7 contents	ASCII	R/W

42055	0808				
42100 : 42227	0834 : 08B3	128	Color for messages 0 ~ 127 at second row.	1: Blue 2: Green 3: Sky Blue 4: Red 5: Purple 6: Yellow 7: White 8: Random	R/W
42300 : 42427	08FC : 097B	128	Message moving type for messages 0 ~ 127	0:Common 1:Instant	R/W
42500 : 42539	08FC : 09EB	40	Color for coil variable 0 ~ 39	1: Blue 2: Green 3: Sky Blue 4: Red 5: Purple 6: Yellow 7: White 8: Random	R/W
42700 : 42763	0A8C : 0ACB	64	Color for integer variable 0 ~ 63		R/W
42700 : 42763	0A8C : 0ACB	64	Color for float variable 0 ~ 63		R/W

# Appendix B. Revision History

This chapter provides revision history information to this document.

The table below shows the revision history.

Revision	Date	Description
1.0.0	July 2019	Initial issue